

hp 39g+ graphing calculator

---

# Mastering the hp 39g+

A guide for teachers, students and other  
users of the hp 39g+, hp 39g & hp 40g



**i n v e n t**



Edition 1.1

HP part number F2224-90010

Printed Date: 2005/10/11

# Table of Contents

<b>Introduction.....</b>	<b>12</b>
<b>How to use this Manual.....</b>	<b>13</b>
Early High School.....	13
Pre-Calculus.....	14
Calculus.....	14
<b>Where's the ON button?.....</b>	<b>15</b>
<b>Some Keyboard Examples.....</b>	<b>16</b>
<b>Keys &amp; Notation Conventions .....</b>	<b>17</b>
<b>Some essential keys .....</b>	<b>17</b>
The SHIFT key .....	17
The ALPHA key .....	18
The Screen keys .....	18
Pop-up menus & short-cuts.....	18
<b>Everything revolves around Aplets! .....</b>	<b>21</b>
Some typical aplet views .....	22
<b>The HOME view.....</b>	<b>25</b>
<b>What is the HOME view?.....</b>	<b>25</b>
<b>Exploring the keyboard.....</b>	<b>26</b>
The screen keys .....	26
Aplet related keys .....	26
The arrow keys .....	26
The SYMB, PLOT and NUM keys.....	27
Intro to the VIEWS menu .....	28
The VARS key .....	28
The SETUP views .....	30
The MODES view .....	30
Numeric formats .....	31
The ANS key .....	32
The negative key .....	33
The CHARS key.....	33
The DEL and CLEAR keys .....	34
<b>Angle and Numeric settings.....</b>	<b>35</b>
<b>Memory Management.....</b>	<b>37</b>
The MEMORY MANAGER view.....	37
Downloaded aplets & memory .....	38
The GRAPHICS MANAGER .....	39
The LIBRARY MANAGER.....	39
<b>Fractions on the hp 39g+.....</b>	<b>40</b>
Pitfalls to watch for .....	42
<b>The HOME History .....</b>	<b>43</b>
COPYing calculations.....	43
Clearing the History .....	44
SHOWing results.....	44
<b>Storing and Retrieving Memories .....</b>	<b>45</b>
<b>Referring to other aplets from the HOME view.....</b>	<b>46</b>
<b>An introduction to the MATH Menu .....</b>	<b>47</b>
<b>Resetting the calculator.....</b>	<b>48</b>
Soft reboot.....	48
Soft reboot (Hardware).....	49
Hard reboot (with memory wipe) .....	49
<b>Summary .....</b>	<b>50</b>

<b>The Function Aplet .....</b>	<b>51</b>
Choose the aplet .....	51
The SYMB view .....	52
The XT0 button .....	52
 ing your function .....	52
The NUM view .....	53
The PLOT view .....	53
<b>Auto Scale .....</b>	<b>54</b>
<b>The PLOT SETUP view .....</b>	<b>55</b>
Detail vs. Faster .....	55
Simultaneous .....	56
Connect .....	56
Axes .....	56
Labels .....	56
Grid .....	56
<b>The default axis settings .....</b>	<b>57</b>
<b>The  Bar .....</b>	<b>57</b>
The MENU toggle .....	57
<b>The Menu Bar functions .....</b>	<b>58</b>
Trace .....	58
Defn .....	58
Goto .....	59
The Zoom Sub-menu .....	60
Center .....	60
In/Out .....	60
Box .....	61
X-Zoom In/Out x4 and Y-Zoom In/Out x4 .....	62
Square .....	62
Auto Scale, Decimal, Integer and Trig .....	62
<b>The FCN menu .....</b>	<b>63</b>
Root .....	63
Intersection .....	64
Slope .....	64
Signed area .....	65
Definite integrals .....	65
Tracing the integral in PLOT .....	66
Areas between and under curves .....	67
Extremum .....	68
<b>Tips &amp; Tricks - Function .....</b>	<b>69</b>
Finding a suitable set of axes .....	69
Composite functions .....	71
Using functions in the HOME view .....	72
Differentiating .....	73
Circular functions .....	74
Trig functions .....	76
Retaining calculated values .....	77
The NUM view revisited .....	77
ZOOM .....	78
Integration: The definite integral using the $\int$ function .....	80
Integration: The algebraic indefinite integral .....	81
The hp 40g Computer Algebra System .....	82
Integration: The definite integral using PLOT variables .....	83
Piecewise defined functions .....	85
'Nice' scales .....	86
Use of brackets in functions .....	87

Problems when evaluating limits .....	88
Gradient at a point.....	90
Finding and accessing polynomial roots .....	91
<b>The VIEWS menu .....</b>	<b>92</b>
Plot-Detail .....	93
Plot-Table .....	94
Overlay Plot.....	95
Auto Scale .....	96
Decimal, Integer & Trig.....	97
<b>Downloaded Aplets from the Internet .....</b>	<b>99</b>
Curve Areas.....	99
Linear Programming.....	99
<b>The Parametric Aplet.....</b>	<b>100</b>
Choose XRng, YRng & TRng.....	100
The effect of TRng.....	101
TStep controls smoothness.....	101
<b>Tips &amp; Tricks - Parametric equations .....</b>	<b>103</b>
<b>Fun and games .....</b>	<b>103</b>
Example 1.....	103
Example 2.....	103
<b>Vectors .....</b>	<b>104</b>
Example 1.....	104
Example 2.....	105
<b>The Polar Aplet.....</b>	<b>106</b>
Choose XRng, YRng & $\theta$ Rng .....	106
$\theta$ Step and smoothness.....	106
Changing the default for $\theta$ Step.....	106
Circular circles .....	106
<b>The Sequence Aplet .....</b>	<b>107</b>
Recursive or non-recursive .....	107
First, second & general terms .....	107
Convenient screen keys provided .....	108
<b>Tips &amp; Tricks - Sequences &amp; Series.....</b>	<b>110</b>
Defining a generalized GP and the sum to n terms. ....	110
Solving sequence problems .....	110
Modeling loans .....	112
<b>The Solve Aplet.....</b>	<b>113</b>
Equations vs. expressions.....	113
Entering the equation .....	113
Solving for a missing value.....	114
The INFO report .....	114
Multiple solutions and the initial guess.....	115
Graphing in Solve.....	116
Transferring approximate solutions.....	116
Referring to functions from other aplets .....	117
A detailed explanation of PLOT in Solve.....	118
The meaning of <b>INFO</b> messages.....	120
<b>Tips &amp; Tricks - Solve .....</b>	<b>121</b>
Easy problems.....	121
Harder problems.....	121

<b>The Stats Aplet - Univariate Data .....</b>	<b>122</b>
Uni vs. Bi-variate data .....	122
Clearing data .....	122
Sorting data .....	123
The STATS key .....	123
Functions of columns .....	124
Registering columns as 'in use' .....	124
Working with frequency tables .....	125
Auto scale .....	125
Plot Setup options .....	126
Box and whisker graphs .....	126
The effect of HRng .....	127
Grouped data & HWidth .....	127
<b>Tips &amp; Tricks - Univariate Data.....</b>	<b>129</b>
New columns as functions of old.....	129
Simulating Dice .....	129
Simulating Random Variables.....	130
<b>The Stats Aplet - Bivariate Data .....</b>	<b>132</b>
Uni vs. Bi-variate data .....	132
Clearing data .....	132
Entering data as ordered pairs.....	133
Adjusting the symbols used to plot points .....	133
The cursor .....	133
Sorting paired columns.....	134
Specifying the fit model .....	134
Multiple data sets .....	134
Choosing from available fit models .....	135
The User Defined model .....	135
Connected data .....	136
Two Variable Statistics .....	137
Showing the line of best fit .....	138
Predicting using PREDY .....	140
Predicting using the PLOT view.....	140
ReTErr as a measure of non-linear fit.....	141
<b>Tips &amp; Tricks - Bivariate Data.....</b>	<b>143</b>
New columns as functions of old.....	143
Using values from <b>STATS</b> in calculations .....	143
Obtaining coefficients from the fit model .....	145
Finding Fit Coefficients.....	145
Correct interpretation of the PREDX function .....	146
Assigning rank orders to sets of data.....	147
Using Stats to find equations from point data .....	148
<b>The Inference aplet.....</b>	<b>150</b>
Using the Chi2 test on a frequency table .....	150
Hypothesis test: T-Test $1-\mu$ .....	151
Confidence interval: T-Int $1-\mu$ .....	153
Hypothesis test: T-Test $\mu_1 - \mu_2$ .....	154
Hypothesis test: Z-Test $1-\mu$ .....	156
<b>Tips &amp; Tricks - Inference.....</b>	<b>158</b>
Importing from a frequency table .....	158

<b>The Finance applet .....</b>	<b>160</b>
Parameters .....	160
Straightforward compound interest .....	161
Annuity .....	162
Loan calculations .....	162
Amortization .....	163
<b>The Quad Explorer teaching applet .....</b>	<b>164</b>
Objectives .....	164
Choosing the level .....	164
GRAPH mode .....	164
SYMB mode .....	165
Self test mode .....	166
<b>The Trig Explorer teaching applet .....</b>	<b>167</b>
Objectives .....	167
SIN vs. COS .....	167
SYMB vs. GRPH mode .....	167
<b>Using Matrices on the hp 39g+ .....</b>	<b>170</b>
The MATRIX Catalog .....	170
Matrix calculations in the HOME view .....	171
Solving a system of equations .....	172
Finding an inverse matrix .....	174
The dot product .....	175
<b>Using Lists on the hp 39g+ .....</b>	<b>176</b>
The list variables .....	176
Operations on lists .....	176
Statistical columns as lists .....	176
List functions .....	177
Editing a list .....	177
Operations on elements .....	177
<b>Using the Notepad Catalog .....</b>	<b>178</b>
Applet notes vs. independent notes .....	178
<b>Independent Notes and the Notepad Catalog .....</b>	<b>179</b>
Transferring notes using IR .....	180
Editing software .....	180
<b>Software .....</b>	<b>181</b>
For the hp 38g, hp 39g & hp 40g .....	181
For the hp 39g+ .....	181
<b>Creating a Note .....</b>	<b>182</b>
Locking ALPHA mode .....	182
The CHARS view .....	183
Corrupting notes .....	183
<b>Using the applet Sketchpad .....</b>	<b>184</b>
Adding text to a sketch .....	184
<b>The DRAW menu .....</b>	<b>185</b>
DOT+ .....	185
LINE .....	185
BOX .....	185
CIRCLE .....	186
Cut and paste (sort of...) .....	186
Capturing the PLOT screen .....	187

<b>Using, Copying &amp; Creating aplets.....</b>	<b>189</b>
<b>Creating a copy of a Standard aplet.....</b>	<b>190</b>
Copying and adding to the Function aplet.....	190
Copying and adding to the Stats aplet.....	191
<b>Some examples of saved aplets.....</b>	<b>192</b>
The Triangles aplet.....	192
The Prob. Distributions aplet.....	192
The Transformer aplet.....	194
<b>Copying from hp 39g+ to hp 39g+ via the infra-red link.....</b>	<b>197</b>
The infra-red port.....	197
Time out.....	199
Attached programs.....	199
<b>Downloading aplets from the Internet.....</b>	<b>200</b>
Finding aplets.....	200
Organizing your collection.....	201
Software for the hp 38g, hp 39g & hp 40g.....	202
Software for the hp 39g+.....	203
The HPGComm Connectivity Program.....	204
Deleting downloaded aplets from the calculator.....	207
Saving notes, aplets and sketches via the Connectivity Kit.....	208
Capturing screens using the Connectivity Kit.....	210
Editing Notes with the Aplet Development Kit.....	211
<b>Programming the hp 39g+.....</b>	<b>212</b>
<b>The design process.....</b>	<b>212</b>
An overview.....	212
Choosing the parent aplet.....	212
Naming conventions.....	213
Planning the VIEWS menu.....	214
The SETVIEWS command.....	214
Special entries in the SETVIEWS command.....	216
The 'Start' entry.....	217
Example aplet #1.....	217
Example aplet #2.....	222
Example aplet #3.....	224
Example aplet #4.....	226
<b>Programming Commands.....</b>	<b>233</b>
<b>The Aplet commands.....</b>	<b>233</b>
CHECK & UNCHECK.....	233
SELECT.....	233
SETVIEWS.....	234
<b>The Branch commands.....</b>	<b>234</b>
IF THEN [ELSE] END.....	234
CASE.....	234
IFFERR THEN [ELSE] END.....	234
RUN.....	235
STOP.....	235
<b>The Drawing commands.....</b>	<b>235</b>
ARC.....	235
BOX.....	235
ERASE.....	236
FREEZE.....	236
LINE.....	236
PIXON and PIXOFF.....	236
TLINE.....	236

<b>The Graphics commands .....</b>	<b>237</b>
<b>The Loop commands .....</b>	<b>237</b>
FOR <var> = <start> TO <end> [STEP] <statements> END .....	237
DO UNTIL.....	237
WHILE REPEAT.....	237
BREAK .....	238
<b>The Matrix commands.....</b>	<b>238</b>
EDITMAT.....	238
REDIM .....	238
<b>The Print commands.....</b>	<b>239</b>
PRDISPLAY .....	239
PRHISTORY.....	239
PRVAR .....	239
<b>The Prompt commands.....</b>	<b>240</b>
BEEP .....	240
CHOOSE .....	240
DISP .....	241
DISPXY .....	241
DISPTIME.....	241
GETKEY .....	241
INPUT.....	242
MSGBOX.....	242
PROMPT .....	242
WAIT.....	242
<b>The MATH menu functions .....</b>	<b>243</b>
<b>The 'Real' group of functions.....</b>	<b>246</b>
CEILING .....	246
DEG → RAD .....	246
FLOOR .....	246
FNROOT .....	247
FRAC.....	247
HMS → .....	248
→HMS.....	248
INT .....	249
MANT .....	249
MAX.....	249
MIN .....	250
MOD .....	250
% .....	250
%CHANGE .....	251
%TOTAL.....	251
RAD → DEG .....	251
ROUND .....	252
SIGN.....	252
TRUNCATE.....	253
XPON .....	253
<b>The 'Stat-Two' group of functions .....</b>	<b>254</b>
PREDY .....	254
PREDX .....	254
<b>The 'Symbolic' group of functions .....</b>	<b>255</b>
The = 'function' .....	255
ISOLATE .....	255
LINEAR?.....	256
QUAD .....	256
QUOTE.....	257
The   function.....	258



<b>The 'Tests' group of functions.....</b>	<b>259</b>
<b>The 'Trigonometric' &amp; 'Hyperbolic' groups of functions.....</b>	<b>259</b>
COT, SEC etc.....	259
EXP .....	260
ALOG.....	260
EXPM1 .....	260
LNP1.....	261
<b>The 'Calculus' group of functions .....</b>	<b>261</b>
<b>The 'Complex' group of functions .....</b>	<b>262</b>
ABS .....	263
SIGN.....	263
ARG.....	264
CONJ.....	264
IM & RE .....	264
<b>The 'List' group of functions.....</b>	<b>265</b>
CONCAT .....	265
$\Delta$ LIST.....	266
MAKELIST.....	266
$\pi$ LIST.....	267
POS.....	267
SIZE.....	268
$\Sigma$ LIST.....	268
REVERSE .....	268
SORT.....	268
<b>The 'Loop' group of functions .....</b>	<b>269</b>
ITERATE .....	269
RECURSE.....	270
$\Sigma$ (SUMMATION).....	270
<b>The 'Matrix' group of functions.....</b>	<b>271</b>
COLNORM .....	271
COND.....	271
CROSS.....	271
DET .....	272
DOT.....	272
EIGENVAL.....	272
EIGENVV.....	272
IDENTMAT .....	272
INVERSE.....	273
LQ.....	273
LSQ .....	274
LU.....	274
MAKEMAT.....	274
QR .....	274
RANK.....	274
ROWNORM.....	274
RREF.....	274
SCHUR.....	275
SIZE.....	275
SPECNORM.....	275
SPECRAD .....	275
SVD .....	275
SVL.....	275
TRACE .....	276
TRN .....	276

<b>The 'Polynomial' group of functions</b> .....	<b>277</b>
POLYCOEF .....	277
POLYEVAL .....	277
POLYFORM .....	278
POLYROOT .....	279
<b>The 'Probability' group of functions</b> .....	<b>280</b>
COMB .....	280
The ! function .....	280
PERM .....	281
RANDOM .....	281
RANDSEED .....	281
UTPN .....	282
UTPC .....	283
UTPF .....	283
UTPT .....	283
<b>Appendix A: Worked Examples</b> .....	<b>284</b>
<b>Finding the intercepts of a quadratic</b> .....	<b>284</b>
Method 1 - Using the QUAD function in HOME. ....	284
Method 2 - Using the Function applet. ....	284
Method 3 - Using the POLYROOT function .....	285
<b>Finding complex solutions to a complex equation</b> .....	<b>285</b>
Method 1 - Using the QUAD function .....	285
Method 2 - Using POLYROOT .....	285
<b>Finding critical points and graphing a polynomial</b> .....	<b>286</b>
<b>Solving simultaneous equations.</b> .....	<b>288</b>
Method 1 - Graphing the lines .....	288
Second method - using a matrix .....	288
Third method - using the 3x3 Solver applet .....	289
<b>Expanding polynomials</b> .....	<b>290</b>
<b>Exponential growth</b> .....	<b>291</b>
<b>Solution of matrix equations</b> .....	<b>293</b>
<b>Inconsistent systems of equations</b> .....	<b>294</b>
Using the RREF function .....	294
<b>Finding complex roots</b> .....	<b>295</b>
<b>Analyzing vector motion and collisions</b> .....	<b>296</b>
<b>Circular Motion and the Dot Product</b> .....	<b>297</b>
<b>Inference testing using the Chi<sup>2</sup> test</b> .....	<b>299</b>
<b>Appendix B: Teaching Calculus with an hp 39g+</b> .....	<b>301</b>
<b>Investigating <math>y = x^n</math> for n an integer</b> .....	<b>301</b>
<b>Domains and Composite Functions</b> .....	<b>302</b>
<b>Gradient at a Point</b> .....	<b>303</b>
<b>Gradient Function</b> .....	<b>304</b>
<b>The Chain Rule</b> .....	<b>305</b>
<b>Optimization</b> .....	<b>305</b>
<b>Area Under Curves</b> .....	<b>306</b>
<b>Fields of Slopes and Curve Families</b> .....	<b>306</b>
<b>Inequalities</b> .....	<b>307</b>
<b>Rectilinear Motion</b> .....	<b>307</b>
<b>Limits</b> .....	<b>307</b>
<b>Piecewise Defined Functions</b> .....	<b>308</b>
<b>Sequences and Series</b> .....	<b>308</b>
<b>Transformations of Graphs</b> .....	<b>309</b>

<b>Appendix C: The hp 40g &amp; its CAS .....</b>	<b>310</b>
<b>Introduction.....</b>	<b>310</b>
What is a CAS? .....	310
What is the difference between the hp 39g, hp 40g & hp 39g+? .....	312
<b>Using the CAS.....</b>	<b>313</b>
Entering and editing an expression .....	313
In-line editing mode .....	316
Erasing, copying, cutting and pasting .....	316
Cursor mode.....	317
The CAS HOME History .....	317
The PUSH and POP commands .....	318
Pasting to an applet.....	319
Evaluating algebraic expressions.....	320
<b>Using functions in the CAS .....</b>	<b>321</b>
E.g. 1 Using LIMIT .....	321
E.g. 2 Factorizing expressions .....	322
E.g. 3 Solving equations.....	323
E.g. 4 Solving simultaneous equations .....	323
E.g. 5 Solving a simultaneous integration .....	325
E.g. 6 Defining a user function .....	327
<b>On-line help.....</b>	<b>328</b>
<b>Configuring the CAS .....</b>	<b>329</b>
<b>Tips &amp; Tricks - CAS .....</b>	<b>330</b>

## Notice

REGISTER YOUR PRODUCT AT: [www.register.hp.com](http://www.register.hp.com)

THIS MANUAL AND ANY EXAMPLES CONTAINED HEREIN ARE PROVIDED "AS IS" AND ARE SUBJECT TO CHANGE WITHOUT NOTICE. HEWLETT-PACKARD COMPANY MAKES NO WARRANTY OF ANY KIND WITH REGARD TO THIS MANUAL, INCLUDING, BUT NOT LIMITED TO, THE IMPLIED WARRANTIES OF MERCHANTABILITY, NON-INFRINGEMENT AND FITNESS FOR A PARTICULAR PURPOSE.

HEWLETT-PACKARD CO. SHALL NOT BE LIABLE FOR ANY ERRORS OR FOR INCIDENTAL OR CONSEQUENTIAL DAMAGES IN CONNECTION WITH THE FURNISHING, PERFORMANCE, OR USE OF THIS MANUAL OR THE EXAMPLES CONTAINED HEREIN.

© Copyright 1993-1998, 2005 Hewlett-Packard Development Company, L.P.

Reproduction, adaptation, or translation of this manual is prohibited without prior written permission of Hewlett-Packard Company, except as allowed under the copyright laws.

Hewlett-Packard Company  
4995 Murphy Canyon Rd,  
Suite 301  
San Diego, CA 92123

### Acknowledgements

Hewlett-Packard would like to thank the author Colin Croft.

### Printing History

Edition 1 February 2004  
Edition 2 September 2005

## **INTRODUCTION**

This booklet is intended to help you to master your hp 39g+ calculator but is also aimed at users of the hp 39g and hp 40g. These are very sophisticated calculators, having more capabilities than a mainframe computer of the '70s, so don't expect to come to grips with its abilities in one or two sessions. However, if you persevere you will gain efficiency and confidence.

The majority of readers may only have used a Scientific calculator before so explanations are as complete as possible. However it is not the purpose of this book to teach mathematics so knowledge will be assumed. Those who are already familiar with another brand or type, may find that a quick skim is sufficient, perhaps with detailed reading of the "Tips and Tricks" sections.

The impact these calculators are having on the topics taught and even more, the way they are taught is proving to be profound. The inventiveness and flexibility of teachers of mathematics is being stretched to the limit as we gradually change the face of teaching in the light of these machines.

For those concerned with the impact of a graphical calculator on the 'fundamentals' of mathematics, it should be recalled that the same fears were held for scientific calculators when they were introduced earlier. History has shown that these fears were generally groundless. Students are learning topics in high school that their parents did not cover until university years. In particular, the scientific calculator proved to be a great boon to students of middle to lower ability in mathematics, relieving them of the burden of tedious calculations and allowing them to concentrate on the concepts. This is also the case with graphical calculators.

This manual is not intended to replace the one supplied with the calculator. It fills in the holes, and also provides tips to make your work smoother and more confident. Happy calculating.

### ***About the author***

Colin Croft is a teacher at St. Hilda's Anglican School for Girls in Perth, Western Australia. Colin has worked extensively with Hewlett Packard on the graphic calculator family of which the hp 39g+ is a member, and was part of the team which created the hp 39g & hp 40g in 2000. He maintains an extensive website of material for the hp 39g/40g/39g+ series called The HP Home view, at <http://www.hphomeview.com>.

## **HOW TO USE THIS MANUAL**

It has been attempted to design this manual to cover the full use of the hp 39g+ calculator. This means explanations which will be useful to anyone from a student who is just beginning to use algebra seriously, to one who is coming to grips with advanced calculus, and also to a teacher who is already familiar with some other brand of graphic calculator.

Readers may encounter one of two difficulties. Firstly, the information in here will be beyond the needs of some readers and secondly, the explanations may be too detailed for more advanced users.

For students who don't yet need the more advanced capabilities, suggestions on which parts of the manual to read are given below. For more advanced users, it is suggested that you read the sections on the Function, Sequence, Statistics, Inference, Finance and Solve aplets, and also read the 'Tips and Tricks' sections which follow many of the chapters.

### ***Early High School***

Typical topics covered include...

Solving linear equations, graphing linear equations and possibly simple quadratics, examining number patterns, multiplying polynomials, factoring simple polynomials, calculations involving powers ( $x^2, x^3, \dots$ ), square roots, cube roots, order of operations, positives and negatives, scientific notation, indices, systems of equations and inequalities, parallel and perpendicular lines, dividing polynomials, solving quadratics, rational expressions and equations.

Suggestions...

Read about the Function aplet in full, ignoring any sections that seem to advanced. Learn about Intersection and Root in the **FCH** menu and make sure you know how the **ZOOM** menu, Autoscale and PLOT SETUP work. Learn to Build Your Own in the NUM view because it lets you find values for rules easily. Learn to use the HOME view for routine calculations, the MODES view, and how to use the calculator's memories. Read about the Solve aplet and how to use it to solve equations. Read about the Statistics aplet and how to use it to find

means and to display histograms. In the MATH menu, read about the functions ROUND, POLYFORM and POLYROOT. Make sure you know how to save and transfer applets. Learn about the Sketch view and the Notes catalog for a bit of fun.

### ***Pre-Calculus***

Typical topics covered include...

Solving complex linear and non-linear simultaneous equations, and trig, exponential & complex quadratic equations, factoring of any quadratic, use and re-arrangement of formulas, indices, trigonometry, some statistics, absolute value and greatest integer functions, matrices, logarithms and parametric equations.

Suggestions...

Cover all of the material mentioned for high school students. Read the suggestions on how to deal with graphs whose shape you don't know in advance. Learn how to use the Parametric applet. Your teacher might best advise on which portions of the Statistics applet will be relevant to you. In the MATH menu, also learn about functions CEILING, ABS and FLOOR, POLYCOEF, and POLYEVAL. Read the section covering the Matrices catalog and the functions DET, RREF, INVERSE, and TRN.

### ***Calculus***

Topics covered here will vary according to which course students undertake but there are very few skills covered in this manual which will not be of use at some time. It is suggested that students skim the whole manual, and then re-read it at intervals as material is covered in their courses and they begin to see which parts of the manual are particularly relevant.

## WHERE'S THE ON BUTTON?

Let's begin by looking at the fundamentals - the layout of the keyboard and which are the important keys that are used frequently. The sketch below shows most of the important keys. These are the ones which control the operation of the calculator - others are used to do calculations once the important keys have set up the environment to do it in.

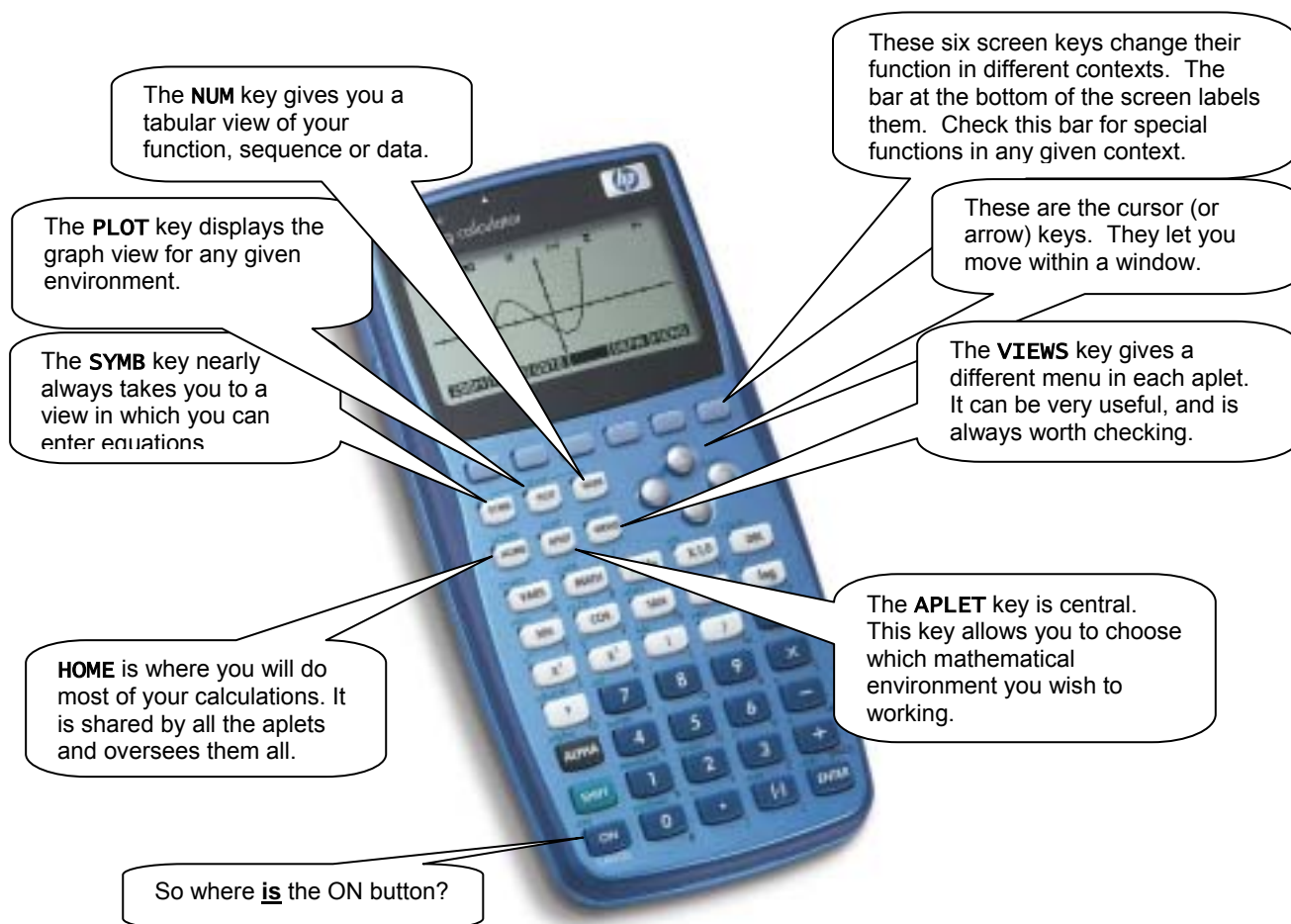

Examples of the effects of each of these keys and many more are shown on the pages that follow.

## SOME KEYBOARD EXAMPLES

Shown below are snapshots of some typical screens you might see when you press each of the keys shown on the previous page. *Exactly what you see depends on which applet is active at the time.*

The applet used below to illustrate this is the **Function** applet, which is used to graph and analyze Cartesian functions. Notice how the meanings of the row of blank screen keys under the screen changes in different views.

The **SYMB** key - in this case it is set to graph the function  $y = x^3 - x^2 - 7x + 6$ .

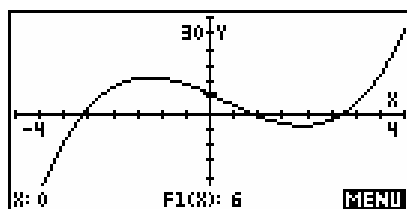
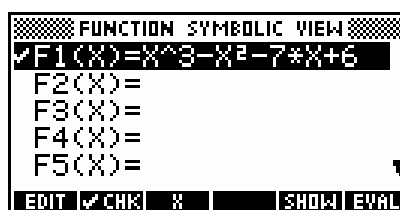

The **PLOT** key - used to graph the function.

The **NUM** key showing a tabular view of the function.

X	F1		
0	6		
1	2.91		
2	1.568		
3	0.837		
4	1.104		
5	1.375		

Bottom row of keys: ZOOM, BIG, DEFN

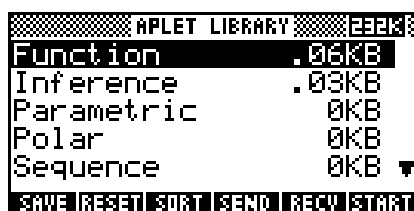

The **APLET** key is used to choose which applet is active. There are 10 applets provided with the calculator and more can be downloaded from the internet.

The **MATH** key gives access to more than a hundred extra functions, grouped by category. The view shown right is currently showing the Probability section.

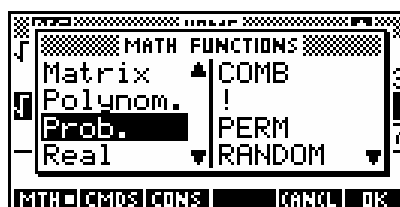



## KEYS & NOTATION CONVENTIONS

There are a number of types of keys/buttons that are used on the hp 39g+.

### *Some essential keys*

The basic keys are those that you see on any calculator including scientific ones, such as the numeric operators and the trig keys. Most of these keys have two or more functions.

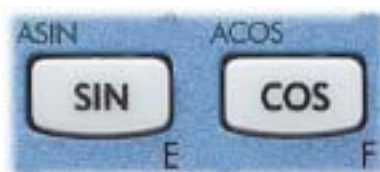

Take for example the **COS** key shown left. If you just press the key, you get the **COS** function. However above left of the key and below right you will see two additional meanings assigned via the **SHIFT** and **ALPHA** keys.

All references to keys, whether they need the **SHIFT** key or not, are written in this typeface: **KEY**.

### *The SHIFT key*



The **SHIFT** key gives you the second function for each key. In the case of the **COS** key, the second function is **ACOS**, sometimes referred to as arc-cos or  $\cos^{-1}$  or inverse cos. Most keys have these second functions that are obtained via the **SHIFT** key.

When I want you to use one of these keys that needs to have the **SHIFT** key pressed first I usually won't say so. It seems to me that you're intelligent enough to work out for yourself when the **SHIFT** key needs to be pressed.

## The ALPHA key

The next modifier key is the **ALPHA** key. This is used to type alphabetic characters, and these appear in orange just below most keys.

## The Screen keys

A special type of key unique to the hp 39g+ and family is the row of blank keys directly under the screen. These keys change their function depending on what you are doing at the time. The easiest way to see this is to press the **APLET** key. As you can see right, the functions are listed at the bottom of the screen. All you have to do is to press the key under the screen definition you want to use.

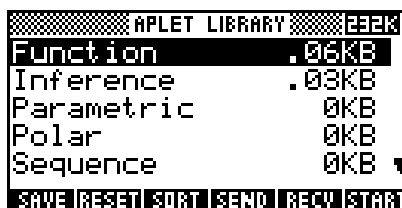

All references to keys of this type are shown as images of the label. For example, if I want you to press the key under the SORT label it would be written as **SORT**. Do it now and you'll see the screen shown on the right. Notice that the keys have now changed function. Press the one under **CANCEL**.

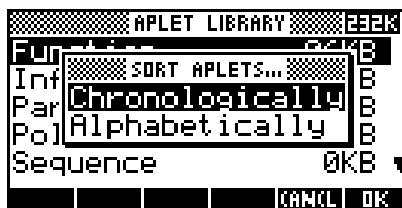

Sometimes pressing a key pops up a menu on the screen as you just saw. You use the up/down arrow keys to move the highlight through the menu and make choices by pressing the **ENTER** key. Choices that are listed in a menu will usually be written using italics. As an example, I might say to press **SORT** and choose *Chronologically*. The manual you are given with your calculator uses a different convention.

As mentioned before, the third way a key can be used is to get letters of the alphabet. This is not so that you can write letters to your friends (although you can do that with the Notepad) but so that you can use variables like X and Y or A and B. The key above the **SHIFT** key labeled **ALPHA** is used to type in letters of the alphabet. Lower case letters are obtained by pressing the **SHIFT** key before the **ALPHA** key. If you want to type in more than just a single letter, hold down the **ALPHA** key. Unfortunately, this doesn't work for lowercase.

Try this...

If you haven't already, **CANCL** out of the menu from the previous screen. Press the **HOME** key to see the screen on the right. Yours may not be blank like mine but that doesn't matter.

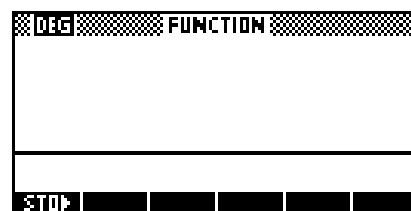

Press **12** and then press the screen key labeled **STO**. Now press the **ALPHA** key and then the alphabetic **D** key (on the **XT0** key). Finally, press the **ENTER** key. Your screen should look like mine on the right. You have now stored the value 12 into memory D. Each alpha key can be used as a memory.



You can also use these memories in calculations. Type in the following (not forgetting the **ALPHA** key before the **D**)... **(3+D)/5 ENTER**  
The calculator will use the value of 12 stored earlier in D to evaluate the expression (see right). In case you haven't worked it out for yourself, the **/** symbol comes from the divide key ( $\div$ ) and the **\*** symbol from the multiply key.



More information on memories and detailed information on the **HOME** view in general is given on pages 45.

The calculator also comes with a large number of mathematical functions that are very useful. They can all be obtained via menus through the **MATH** key. Try pressing the **MATH** key now and you should find your screen looks like the screen shot on the right.

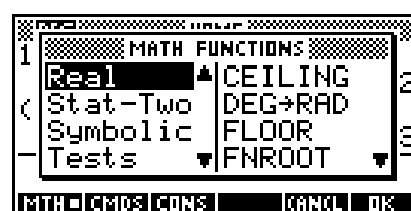

The **MATH** menu is covered in detail on pages 243 but we will have a brief look now.

The left side of the menu lists the categories of functions. As you use the up/down arrows to scroll through the topics, you'll see the actual list on the right change. Move down through the menu until you reach *Prob.* (short for Probability) and then one step more and you'll find yourself back at *Real*. Now press the right arrow key and your highlight will move into the right hand menu (see above). Move the highlight down through this menu until you reach *Round*. Press **ENTER**.

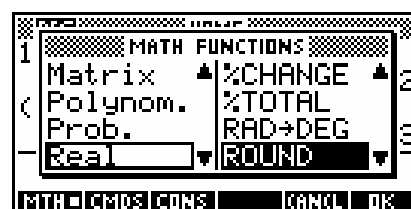

You should now be back **HOME**, with the function **ROUND(** entered in the display as shown right. You can also achieve the same effect by using **ALPHA** to type in the word letter by letter. Some people prefer to do it that way.



Now type in: **4+D/18,3)** and press **ENTER**

As you can see, the effect was to round off the answer of 4.666666.. to 3 decimal places.

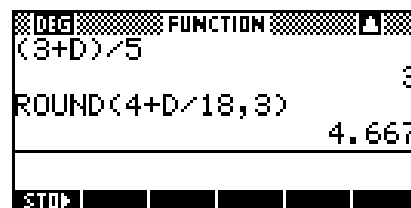

There are shortcuts for obtaining things from the **MATH** menu that are covered later (see page 47).

## **EVERYTHING REVOLVES AROUND APLETS!**

A set of “aplets” is provided in the **APLET** view on the hp 39g+. This effectively means that it is not just one calculator but nine (or more), changing capabilities according to which aplet is chosen.

The best way to think of these aplets is as “environments” or “rooms” within which you can work. Although these environments may seem dissimilar at first, they all have things in common, such as that the **PLOT** key produces graphs, that the **SYMB** key puts you into a screen used to enter equations and rules, and that the **NUM** key displays the information in tabular form.

There are ten standard aplets available via the **APLET** key. More can be created by you or obtained via the Internet (see pages 212 & 200)

### ***The Function aplet (see page 51)***

Provides  $f(x)$  style graphs, calculus functions etc. It will not only graph but find intercepts, intersections, areas and turning points.

### ***The Inference aplet (see page 150)***

Allows the investigation of inferential statistics via hypothesis testing and confidence intervals. This was not available on the hp 38g, the original calculator upon which the hp 39g+ was based.

### ***The Parametric aplet (see page 100)***

Handles  $x(t)$ ,  $y(t)$  style graphs. Can also be used to help with vector motion.

### ***The Finance aplet (see page 160)***

Performs calculations involving time/value of money.

### ***The Polar aplet (see page 106)***

Handles  $r(\theta)$  style graphs. Quite apart from their mathematical use, they produce some really lovely patterns!

**The Quadratic Explorer applet (see page 164)**

This is a teaching applet, allowing the student to investigate the properties of quadratic graphs.

**The Sequence applet (see page 107)**

Handles sequences such as  $T_n = 2T_{n-1} + 3$ ;  $T_1 = 2$  or  $T_n = 2^{n-1}$ .  
Allows you to explore recursive and non-recursive sequences.

**The Solve applet (see page 113)**

Solves equations for you. Given an equation such as  $A = 2\pi r(r + h)$  it will solve for any variable if you tell it the values of the others.

**The Statistics applet (see page 122 & 132)**

Handles descriptive statistics really well. Data entry is easy, as is editing. It analyzes univariate and bivariate data, drawing scatter graphs, histograms and box & whisker graphs.

**The Trig Explorer applet (see page 167)**

This is a teaching applet, allowing the student to investigate the properties of sine and cosine graphs.

The Function applet is probably the easiest to understand and also the one you will use most often, so we will have a very quick look at this applet.

The **APLET** key is used to list all the applets and start, reset or save them.



The **SYMB** view is used to enter equations....  
It can store up to ten functions.

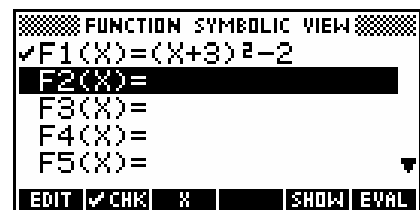

The **NUM** view shows the function in table form...

X	F1		
7	7		
7.61	7.61		
8.24	8.24		
8.89	8.89		
9.56	9.56		
10.25	10.25		

ZOOM BIG DEFN

The **PLOT** view is used to display the function as a graph...

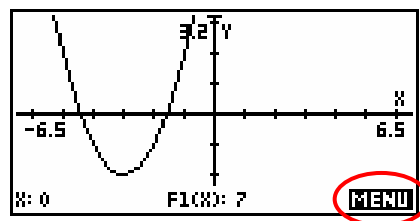

The **MENU** key gives access to a number of other useful tools allowing further analysis of the function.

Although these views are superficially different in other applets, the basic idea is usually similar.

Having said that applets are best thought of as “working environments”, it is equally true that applets are essentially programs, with the standard ones simply being built into the calculator. This is a programmable calculator, having its own programming language and able to perform quite sophisticated tasks.

Unless you particularly want to learn about the programming language, there is no reason why you should worry about it. The standard applets will cover all of your normal requirements in mathematics.

However one of the great strengths of the hp 39g+ is its ability to “download” additional applets from other calculators, from a PC or Mac and from the Internet. See page 200.

A cable and software were provided with your hp 39g+ which you can use to connect your PC or Mac to your calculator and then download applets from the computer to the calculator or to save your work to the computer. If you have an hp 38g, hp 39g or hp 40g then you need to buy the cable separately.

If you are using an hp 39g+ then the cable connects to the USB port on your computer. If you are using an hp 39g or an hp 40g then you will need to purchase the cable and download the software from Hewlett-Packard’s website.

More information on this can be found on pages 200 - 226.



#### **Calculator Tip**

Search on the web using the key word “hp 39g” and you will find a variety of sites which contain information and applets.

Once an applet is transferred onto any one calculator, transferring it to another takes only seconds using the built in infra-red link at the top of each calculator. This is exactly like the remote control of a VCR, and allows two calculators to talk to each other. In the interests of security in examinations the distance over which they can communicate is limited to about 8 - 10cm (about 3 - 4 inches). See page 197 for details on this process.

Applets are available to do many mathematical tasks such as statistical simulations, time series analysis and many tasks called for in calculus, physics and chemistry. There are a number of web sites which offer applets.

The Hewlett-Packard site is found at...

<http://www.hp.com/calculators/>  
(follow the links to graphical calculators and then to the library of applets)

In addition to this you should check the site called *The HP HOME view* which can be found at...

<http://www.hphomeview.com>  
(contains not only applets and games, but also a huge amount of detailed information on the calculator.)



#### **Calculator Tip**

The applets for an hp 39g, hp 40g and hp 39g+ are interchangeable but not those of an hp 38g. If you load an applet from an hp 38g onto an older model then the download will appear to be successful but the calculator will “crash” when the applet is run.

The entire topic of applets is discussed in more detail in the chapter entitled “Using, copying & creating applets” on page 189.



## ***THE HOME VIEW***

In addition to these applets, there is also the **HOME** view, which can best be thought of as a scratch pad for all the others. This is accessed via the **HOME** key (just below the **APLET** key) and is the view in which you will do your routine calculations such as working out 5% of \$85, or finding  $\sqrt{35}$ . The **HOME** view is the view that you will most often use, so we will explore that view first.

### ***What is the HOME view?***

This is the **HOME** base for the calculator. All other applets can be accessed from it and affect it to varying degrees, and all mathematical functions are available in this view. Learn to use this view as efficiently as possible, since a great deal of work will be done here.



We will explore the **HOME** view in the following order:

1. [Exploring the Keyboard](#)
2. [Angle and numeric settings](#)
3. [Memory management](#)
4. [Fractions on the hp 39g+](#)
5. [The HOME History](#)
6. [Storing and retrieving memories](#)
7. [Referring to other applets from the HOME view](#)
8. [An introduction to the MATH menu](#)
9. [Resetting the calculator](#)

## Exploring the keyboard

It is worth familiarizing yourself with the mathematical functions available on the keyboard. If we examine them row by row, you will see that they tend to fall into two categories - those which are specific to the use of aplets, and those which are commonly used in mathematical calculations.

The first row of blank keys are context defined. The reason they have no label is that their meaning is redefined in different situations - they are the 'screen keys'. The current meaning of each key is listed in the row of boxes at the bottom of the screen.

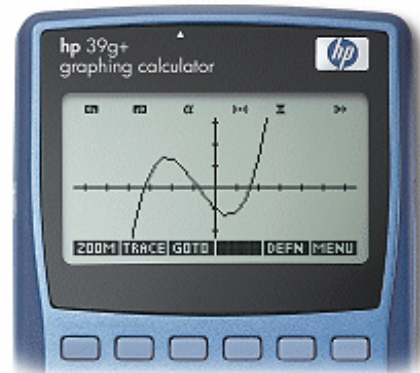

A common abbreviation used for these keys is SK1 or SK2 etc (for "screen key 1"). In the **PLOT** view shown above, some of the screen keys are labeled, such as the **MENU** key. When you press this the row of screen keys labels appear or disappear. To see another view where all the keys are in use, change to the **APLET** view.



### Calculator Tip

Develop the habit of checking the screen to see if any of those keys have been given meanings. In many views, the screen keys have been set up with useful shortcuts and functions.

The next two rows of keys and part of the third are mainly aplet related, so we'll deal with them as a group.

The arrow keys on the right are used in most views, usually to move the cursor (a small cross) or the highlight around on the screen.





The **APLET** key is used to choose between the various different aplets available. Everything in the calculator revolves around aplets, which you can think of either as miniature programs or as environments within which you can work.

The hp 39g+ comes with ten standard aplets - Finance, Function, Inference, Parametric, Polar, Quadratic Explorer, Sequence, Solve, Statistics and Trig Explorer. Which one you want to work with is chosen via the **APLET** key.

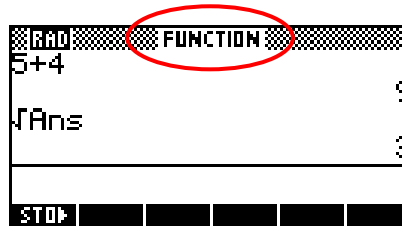



**Calculator Tip**  
 The name of the active aplet is shown at the top of the screen, as above. It is important to bear this in mind because the angle and numeric settings are tied to the active aplet. Changing aplets may therefore cause these settings to change in **HOME** too.

See page 35 for more details on this.

In addition to the standard ten, covered in great detail in the chapters following, many more aplets are available from the Internet written by other programmers. Once these are downloaded into your calculator they can also be accessed via the **APLET** key. For more detail on this type of aplet, see the brief summary later in this section, and the chapter entitled “Programming the hp 39g+” on page 212.

The **SYMB**, **PLOT** and **NUM** keys are used within aplets to move from view to view. In most aplets the **PLOT** view shows the graph, the **SYMB** view shows the equations and the **NUM** view shows the equations in tabular (numeric) format.



The **VIEWS** key pops up a menu from which you can choose various options. Part of the **VIEWS** menu for the Function aplet is shown right. See page 92 for more information.

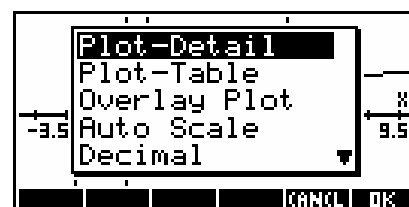

The **VIEWS** menu is provided for two purposes...

Firstly, within the standard aplets (Function, Sequence, Solve etc.) it provides a list of special views available to enhance the **PLOT** view.

For example the standard **PLOT** screen provides a graph, but the **VIEWS** menu lets you use a split screen such as shown right. Information on the **VIEWS** menu is given in the chapter dealing with the Function applet.

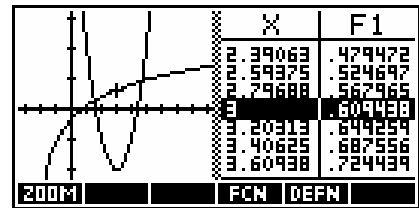

In addition to this, the **VIEWS** key also has a critical role when using aplets which have been downloaded from the Internet. When a programmed applet is created for the hp 39g+, a menu is provided by the programmer to let you control and use it. This menu is tied to the **VIEWS** key, replacing the menu normally found on the key. For example, the snapshot shown right is of a **VIEWS** menu taken from an applet designed to analyze and graph Time Series data.

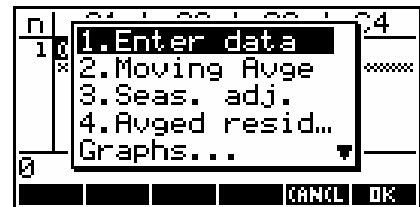

The next important key is the **HOME** key. It allows you to change into the **HOME** view from wherever you are. Above it is the **MODES** key, accessed by pressing **SHIFT** first. Far more detailed information on these two views follows later.

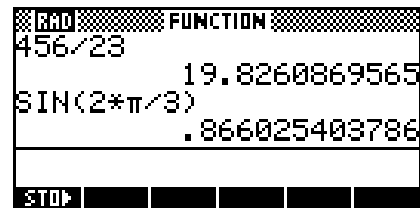

The **VARs** key is used (mainly by programmers) to access all the different variables stored by the calculator.

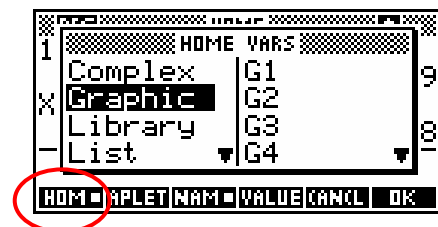

Shown right are two views of the **VARs** screen, the first from the **HOME** list showing the graphic variables (memories) **G1**, **G2**.... and the next from the **APLET** list showing some of the variables in the set controlling **PLOT**.

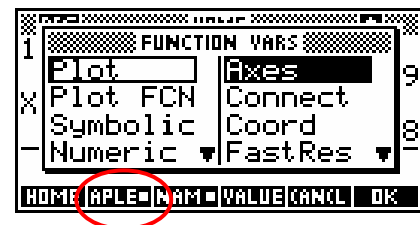

The **VARs** key is not generally used much, and you may not have followed this explanation. Don't worry. The **VARs** key is mostly used by programmers who want to produce aplets of their own and is discussed in more detail in the chapter entitled "Programming on the hp 39g+" on page 212. Uses are also detailed in the Function applet's "Tips and Tricks" section on page 69.

The **MATH** key next to **VARS** provides access to a library of mathematical functions. The more common functions have keys of their own, but there is a limit to the number of keys that one can put on a calculator before it takes too long to find the key required.

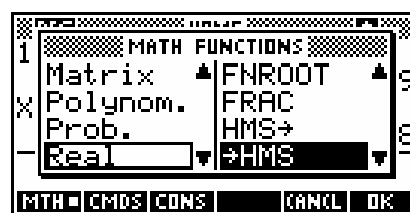

The **MATH** menu lists all those functions that would not fit onto the keyboard plus some which also appear on the keyboard. Shown in the screen snapshot above is a small selection of the total list. For a listing of almost all the functions, with examples of their use, see the chapter entitled “The MATH Menu” on page 243.

Most of the keys have another function in light blue above the key. The hp 39g+ gets twice the action from each key by having this second function.



The second function is accessed via the **SHIFT** key on the left side of the calculator. Although this book will sometimes tell you explicitly to press this key, in most cases it will be assumed that you are intelligent enough to work out for yourself when it is necessary to press it.

The **ALPHA** key gives alphabetical characters, shown below right of most keys. Pressing **SHIFT ALPHA** gives lower case. If you press and hold down the **ALPHA** key you can ‘lock’ alpha mode but this doesn’t work for lower case. Many people use this to type in functions by hand rather than using the **MATH** menu.



#### **Calculator Tip**

You can use the ALPHA button to type in functions by hand instead of going through the MATH menu. This is often faster.

The **SETUP** views, above **PLOT**, **SYMB** and **NUM**, are used to customize their respective views. For example, the **PLOT SETUP** screen controls things like axes, labels etc. Their use changes in different aplets, so for more information see the explanations in the chapters dealing with the various aplets, particularly with the Function aplet on page 55.



In particular, the **SYMB SETUP** key is only used in one place, which is to choose the data model for bivariate statistics in the Statistics aplet. It is not available in the other aplets and trying to access it will result only in a quick flash of an exclamation mark on the screen to say "You've done something wrong!".



Information on the use of the **SKETCH** and **NOTE** keys (above **APLET** and **VEIWS**) can be found in the chapters "Using the Sketchpad" and "Using the Notepad Catalog" on pages 184 & 178. Briefly, any aplet (except for the Quad & Trig Explorer aplets) has a note and a sketch associated with it, which are usually blank unless you have added to them.

The main use for them comes with aplets downloaded from the Internet. Instructions for using the aplet are sometimes included with the aplet in note form, and sometimes as an accompanying sketch.

The **MODES** view (see right) controls the numeric format used in displaying numbers and angles in aplets. At the bottom of the screen you will see that one of the screen keys has been given the function **CHODS**. Pressing this key pops up a menu of choices from which you can select the option which suits you. The default angle setting is radians.

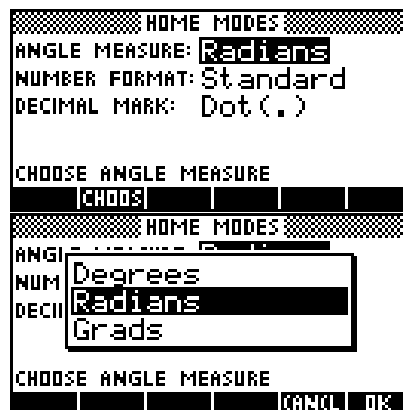

### Calculator Tip

If you don't want to use the menu then, rather than pressing **CHODS**, highlight the field and then press the '+' key repeatedly. This will cycle through the choices without popping up a menu. This can be much faster if the menu has only a few choices.

The choices for 'Number format' are shown on the right. **Standard** is probably the best choice in most cases, although it can be a little annoying to constantly have 12 significant figures displayed. In **Standard** mode, very large and very small numbers are displayed in scientific notation.

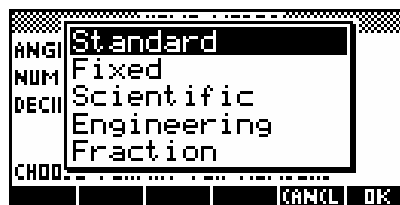

The **Fixed**, **Scientific** and **Engineering** formats all require you to specify how many decimal places to display. The screenshot right shows **Fixed 4**, which rounds everything off to 4 decimal places. Of course, you can change the 4 to any other number you want.

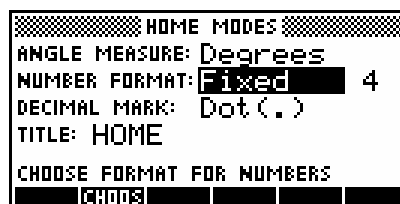

A setting of **Scientific** notation ensures that any results are displayed in scientific notation. Of course, the calculator's idea of scientific notation may not be the same as yours. Since the calculator has no way of displaying powers as superscripts, a result of  $3.203 \times 10^4$  has to be displayed as 3.203E4. The alternative of **Engineering** notation is very similar to **Scientific**, except that powers are always displayed as multiples of 3. This is done to allow easy conversion in the Metric system, which also works in multiples of 1000.

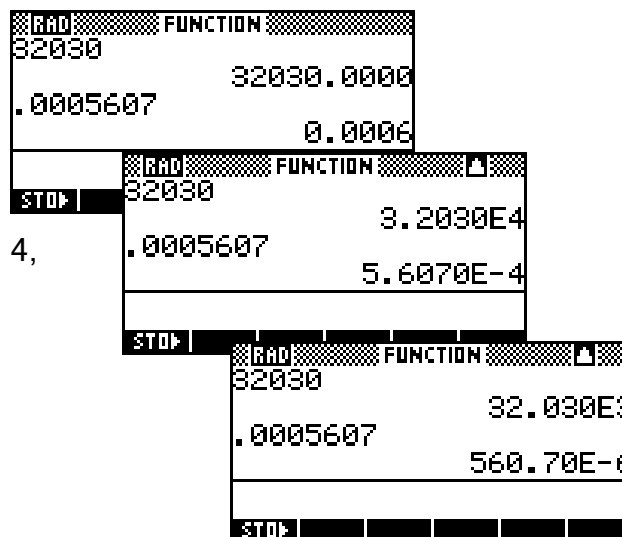

The screens right show the same two numbers displayed as in turn as; **Fixed 4**, **Scientific 4** and **Engineering 4**.

**Calculator Tip**  
 If you have **Labels** turned on when you **ZOOM** in (or out) on a graph then you may end up with axes whose numeric labels are horrible decimals (see below right).

The setting of **Fraction** can be quite deceptive to use and is discussed in more detail on page 40.

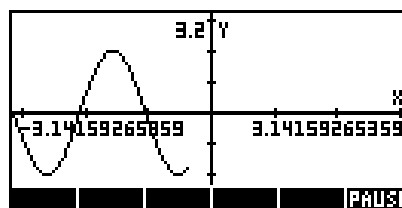

The next alternative in the **MODES** view of 'Decimal Mark' controls the character which is used as a decimal point. In some countries a comma is used instead of a decimal point.



If you opt to use a comma rather than a full stop then any places where a comma would normally be used (such as in lists) will swap to using a full stop. Any functions which might normally have terms separated by a comma will use a full stop instead. For example, **ROUND(3.456,2)** will become **ROUND(3,456.2)**.

Moving back to our tour of the keyboard, the next key is the **ENTER** key. This is used as an all purpose "I've finished - do your thing!" signal to the calculator. In situations where you would normally press the '=' key on most calculators, press the **ENTER** key instead.

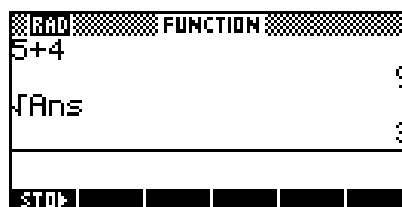

Above the **ENTER** key is the **ANS** key. This can be used to retrieve the final value of the last calculation done. An example of this is shown right.

If you are not confident about using brackets, then the **ANS** key can be quite useful.

For example, you could calculate the value of

$$\frac{3-7 \times 2}{2^2+5^3} \text{ by using brackets...}$$

.... or you could use the **ANS** key.

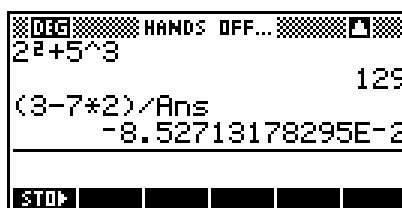
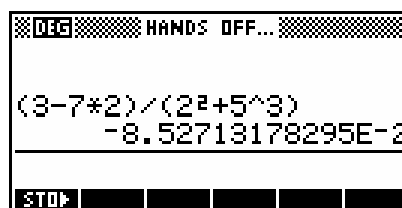



An alternative to using the **ANS** key is to use the History facility and the **COPY** function. This is discussed on page 43.

Another important key is the **(-)** key (shown right).



If you want to calculate the value of (say)  $-2 - (-9)$  then you must use the **(-)** key before the 2 and the 9 rather than the subtract key. If you press the subtract key before the 2 instead of the **(-)** key, then the calculator will enter instead: **Ans - 2**, meaning, subtract 2 from the previous answer. Similarly, entering 'subtract, subtract 9' instead of 'subtract (-) 9' will give an error message of "Invalid syntax", meaning it does not make mathematical sense to have two subtract signs instead of a subtract of a negative.

The reason for the **Ans - 2** is that a subtract cannot start a 'sentence' in mathematics, while a negative sign can. Since the subtract can't come first, the calculator decides that you must have intended to subtract from the previous answer. Hence the sudden appearance of an **Ans**. This occurs at other times too. One of the most common

The next important key is the **CHARS** key (above **VARS**). This key is used to access all of the many characters that are used occasionally but not often enough to bother putting on the keyboard.

Pressing **SHIFT CHARS** will pop up the screen above right. One of the screen keys is set to be a 'Page Down' key (**PAGE** ) , and will give access to two more pages of characters.

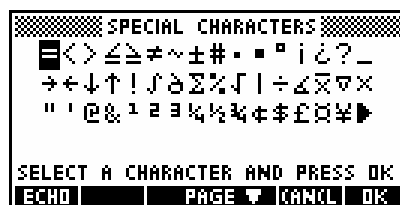

These special characters are obtained by pressing the screen key labeled **ECHO**. You can press **ECHO** as many times as you need to in order to obtain multiple characters. When you have as many as you need, press the **OK** key.

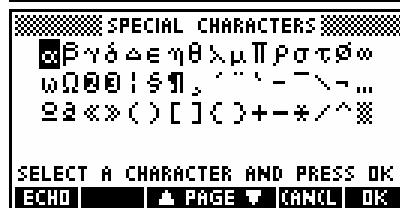

The next important key is the **DEL** key at the top right of the keyboard. This serves as a backspace key when typing in formulas or calculations, erasing the last character typed. If you have used the left/right arrow keys to move around within a line of typing, then the **DEL** key will delete the character above the cursor. The **CLEAR** key above **DEL** can be thought of as a kind of 'super delete' key. For example, if pressing **DEL** would erase one function only in the **SYMB** view then **CLEAR** will erase the whole set.



#### **Calculator Tip**

Another use for the **DEL** key is to restore factory settings. For example, if you move back into the **MODES** screen and change to Degree mode, then pressing the **DEL** key will restore the default of Radians. Pressing **CLEAR** in the **MODES** view would restore factory settings to all the entries. This is particularly useful in the **PLOT SETUP** view.

The remaining keys of **LIST**, **MATRIX**, **MEMORY**, **NOTEPAD** and **PROGRAM** have special chapters of their own.

## Angle and Numeric settings

It is critical to your efficient use of the hp 39g+ that you understand how the angle and numeric settings work. For those upgrading from the hp 38g this is particularly important, since the behavior is significantly different.

On the hp 39g+, when you set the angle measure or the numeric format in the **MODES** view, it applies both to the aplet and to the **HOME** view. However, this setting applies *only* to the currently active aplet (the one highlighted in the **APLET** view). *This means that if you change active aplet then these settings may change also, not only for the aplet but in the **HOME** view too.*

For example, suppose you have been performing trig calculations in the **HOME** view with the Function aplet being currently active, and have set the angle measure to DEG.

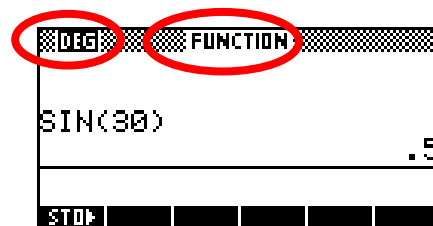

If you were to now change to the Solve aplet in order to solve an equation then the settings would revert to those of the Solve aplet; probably be radians unless you had also changed those as well.

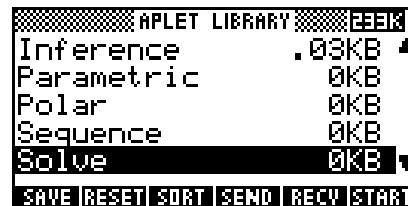

Radian measure is the default for all aplets and thus also for **HOME** unless you change it. Performing the same calculation in **HOME** would now give a different result (see right).

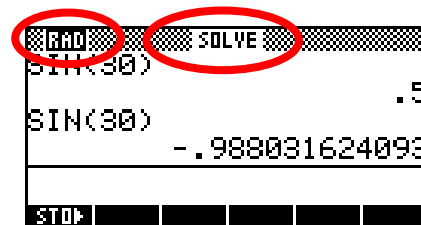

Although this may seem to be a strange way of doing things, there is actually a very good reason for it. The hp 38g did not behave this way and it caused a number of users to have difficulties as you'll see on the next page.

Suppose we define a trig function in the Function apilet as shown.

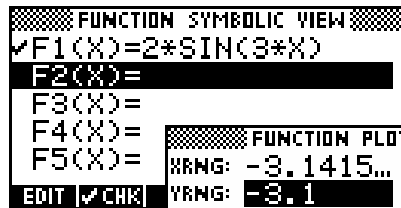

The default setting for the Function apilet is radians, so if we set the axes to extend from  $-\pi$  to  $\pi$ , the graph would look as shown right.

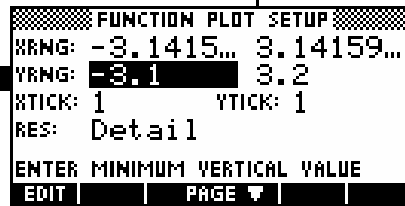

In the PLOT view shown, the first positive root has been found (see page 63) as  $x=1.0471\dots$

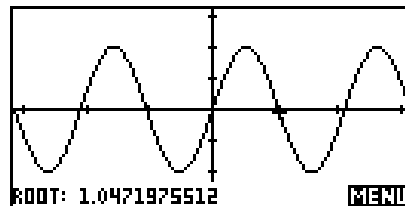

On the hp 39g+, if we now change to the HOME view and perform the calculation shown right, we expect that the answer should be zero, as indeed it is.

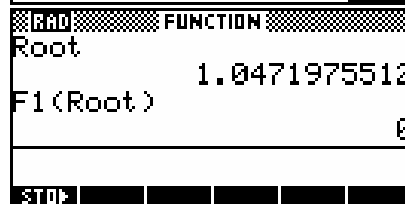

However, this is only the case because the angle measures of HOME and the Function apilet agree. The problem was that on the hp 38g the default setting for the Function apilet was radians, while HOME had a default setting of degrees and its setting was independent of those of the apilet. This meant that a calculation such as the one above would give incorrect results, and caused considerable confusion to some students. It even resulted in users returning their hp 38g to dealers as 'faulty'!

The only drawback of this method is that you might change apilets and forget that it may also change settings. For this reason, the name of the active apilet is shown at the top of the HOME view as a reminder.

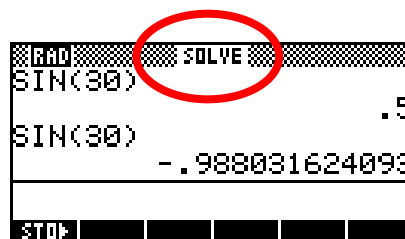

On the hp 39g+ you can see that if we turn Labels on and then PLOT, the numeric mode also affects the axis labels.

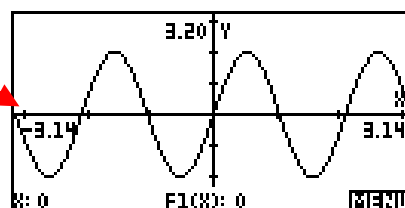
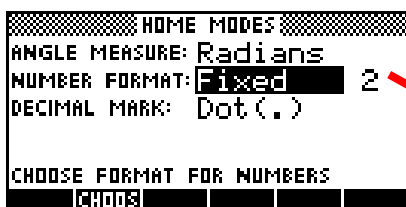

This setting also applies to the appearance of equations and results displayed using the **SHOW** command.



### Calculator Tip

Under the system used on the HP39+, if you want to work in degrees then you will need to choose that setting in the **MODES** view and possibly set it again if you change to another aplet. Some people choose to go through and change the setting on all the aplets at once so that they don't have to remember that it might change. However, if you **RESET** the aplet the default setting will return.

## Memory Management

One of the major complaints about the hp 38g was its memory - mainly the lack of it, but also the inability to control or manage it. This problem has been addressed on the hp 39g+ in two ways. Firstly, the hp 39g+ has over ten times the useable memory of the hp 38g. At 232 Kb (vs. only 23 Kb), there are very few users who will come close to filling the hp 39g+. Depending on size, there is enough room for at least fifty aplets, or for over 10,000 data points.

In addition to extra memory, the hp 39g+ supplies a better way to control it through the **MEMORY MANAGER** view. If you press the **MEMORY** key you will see the view shown right. Scrolling through it will show you exactly how the available memory is currently being used. The remaining memory, in Kb, is shown at the top right of the screen. This view gives an overview of the memory. For detailed management the **VIEW** key is provided.

MEMORY MANAGER			MEM
Aplets	9.7KB	4%	
Programs	36.2KB	15%	
Notes	0KB	<1%	
Matrices	.1KB	<1%	
Lists	0KB	<1%	
			VIEW

MEMORY MANAGER			MEM
Matrices	.1KB	<1%	
Lists	0KB	<1%	
Graphics	1KB	<1%	
History	.1KB	<1%	
Library	0KB	<1%	
			VIEW

Pressing **VIEW** on any entry will take you a relevant screen in which you can delete entries no longer needed.

For example, with the highlight on *Aplets*, pressing **VIEW** will take you to the **APLET** view (right), where you can choose to delete or reset any aplets no longer required.

APLET LIBRARY		MEM
Curve Area	1.9KB	
Coin Tossing	2.1KB	
Statistics	.10KB	
Statistics3	1.1KB	
Statistics2	2.4KB	
SAVE   RESET   SORT   SEND   RECV   START		

As you can see in the screen snapshot on the previous page, my calculator has a number of extra applets. Two of them, *Statistics2* and *Statistics3* are simply copies of the normal Statistics applet containing data that I did not want to lose. The top two applets *Curve Area* and *Coin Tossing* are teaching applets that I have downloaded from the internet.

If you use teaching applets that you download from the internet via the Connectivity Kit, or which are supplied to you by your teacher via the infra-red link on your hp 39g+, then you need to bear in mind that most of them have 'helper' programs that aid them in performing their tasks. In the screens shown right you can see some of the programs which are attached to these two teaching applets. The convention which most hp 39g+ programmers follow is to name these 'helper' programs in a way that associates them clearly with the parent applet.

```

PROGRAM CATALOG 092KB
.CURVE.SV      .21KB
.CURVE.GP      .34KB
.CURVE.S       .07KB
.CURVE.TR      .34KB
.CURVE.UR      .30KB
EDIT | NEW | SEND | RECV | RUN
  
```

```

PROGRAM CATALOG 092KB
.CURVE.FN      .60KB
.COIN.SV       .17KB
.COIN.S        .23KB
.COIN.SH       .38KB
.COIN.TS       .69KB
EDIT | NEW | SEND | RECV | RUN
  
```

The memory associated with these programs is not included in that shown for the applet in the **APLET** view but will not usually be a large amount.



### Calculator Tip

The reason for this naming convention for 'helper' programs is that when you delete the parent applet in the **APLET** view the 'helper' programs are *not* automatically deleted with it. You must change to the **Program Catalog** view and delete them manually after you have finished with the teaching applet and deleted it in the **APLET** view. If you don't do this then they will continue to take up memory on the calculator. Even on the hp 39g+ this is not infinite and too many left over programs will eventually cause problems.

As mentioned on the earlier, pressing **VIEW** in the **MEMORY MANAGER** screen takes you to a relevant view showing greater detail. For example, the *Matrices* entry right shows 0.1 Kb in use. Pressing **VIEW** will take you to the **MATRIX CATALOG** view which shows exactly where the memory is being used and allows you to delete any or all of the matrices, or you can enter the view in the normal way by pressing **SHIFT 4**.

```

MEMORY MANAGER 092KB
Aplets      9.7KB  4%
Programs    36.2KB 15%
Notes       0KB   <1%
Matrices    .1KB  <1%
Lists       0KB   <1%
VIEW
  
```

```

MATRIX CATALOG 092KB
M1 4x4 REAL MATRIX .13KB
M2 4x1 REAL MATRIX .04KB
M3 4x1 REAL MATRIX .04KB
M4 1x1 REAL MATRIX  0KB
M5 1x1 REAL MATRIX  0KB
EDIT | NEW | SEND | RECV | RUN
  
```

The *History* entry will take you to the **HOME** view, where pressing **SHIFT CLEAR** will clear the History.

There are two views, shown right, for which the only access is via the **MEMORY MANAGER** screen. The first of these, the **GRAPHICS MANAGER**, shows some memory in use on my calculator due to the screen captures I am performing to show you these views. Yours will probably be empty.



The second of these is the **LIBRARY MANAGER**, and this will almost certainly be empty unless you have games loaded.

Generally, the only aplets which use libraries are those such as games which are written by expert programmers in machine code in order to make them run as fast as possible. These games, available on the internet, are listed in the **APLET** view along with the normal aplets and when you delete them the associated library *is* automatically deleted with them, unlike the case of the 'helper' programs.



#### **Calculator Tip**

Because of the amount of memory available on the hp 39g+, the Memory View is not one that you will normally need to worry about. It is probably of more interest to programmers.

## Fractions on the hp 39g+

Earlier we examined the use of the **MODES** view, and the meaning of Number Format. We discussed the use of the settings **Fixed**, **Scientific** and **Engineering**, but left the setting of **Fraction** for later. The **Fraction** setting can be a little deceptive.

Most calculators have a fraction key, often labeled  $a^b/c$ , that allows you to input, for example,  $1\frac{2}{3}$  as  $1\rightarrow 2\rightarrow 3$  or something similar. What these calculators usually won't do is allow you to mix fractions and decimals.

On most calculators  $1\frac{2}{3} + 3.7$  will give a decimal result - the calculator will not attempt to convert the  $3.7$  into a fraction. The reason for this is that while some decimals like  $0.25$  are easy to convert to a fraction, others, such as recurring ones, are not so easy. Most calculators opt for the easy option of switching to a decimal answer in any mixture of fractions and decimals. The makers of the hp 39g+ took a very different approach. Once you select **Fraction** mode, all numbers become fractions - including any decimals.

The first point to remember is that there is no provision for inputting mixed fractions such as  $1\frac{2}{3}$ . Fractions are entered using the divide key and, while the calculator is quite happy with improper fractions such as  $5/3$ , it correctly interprets  $1/2/3$  as one half divided by 3 and gives a result of  $1/6$ . The solution to this is simply to enter mixed fractions as  $(1+2/3)$ .



### Calculator Tip

You need to be careful with brackets or “order of operations” problems may occur, such as  $1\frac{2}{3} * \frac{1}{5}$  being interpreted as  $1+(2/3*1/5)$  rather than as it should be:  $(1+2/3)*1/5$ . When in doubt, use brackets for mixed fractions.



Some examples are... (using Fraction 4 or higher)

$$1. \frac{1}{3} + \frac{4}{5} = \frac{17}{15}$$

$$2. 3\frac{1}{3} - 4\frac{1}{2} = -1\frac{1}{6}$$

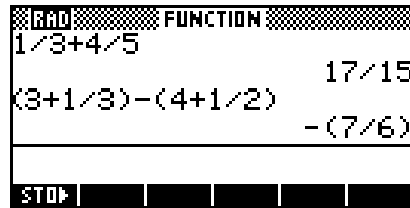

The second point to remember involves the method the hp 39g+ uses when converting decimals to fractions, which is basically to generate (internally and unseen by you) a series of continued fractions which are *approximations* to the decimal entered. The final fractional approximation chosen for display is the first one found which is 'sufficiently close' to the decimal.

The trap lies in what constitutes 'sufficiently close', and this is determined by the '4' in Fraction 4. Roughly, the calculator will use the first fraction it finds in its process of approximation which matches the decimal to that number of significant digits.

For example, a setting in the **MODES** view of...

Fraction 1 changes 0.234 to  $\frac{3}{13}$   
 which is actually 0.2307692...  
 (matching to at least 1 sig. fig.)

Fraction 2 changes 0.234 to  $\frac{7}{30}$   
 which is actually 0.2333333...  
 (matching to at least 2 sig. fig.)

Fraction 3 changes 0.234 to  $\frac{11}{47}$   
 which is actually 0.2340425...  
 (matching to at least 3 sig. fig.)

Fraction 4 changes 0.234 to  $\frac{117}{500}$  (or  $\frac{234}{1000}$ )  
 which is exactly 0.234

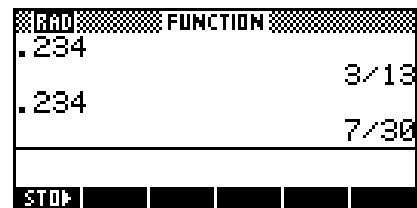

Essentially, the value of 'n' in 'Fraction n' affects the degree of precision used in converting the decimal to a fraction. As was said earlier, the calculator will use the first fraction it finds in its process of approximation which matches the decimal to that number of significant digits.

The Fraction setting is thus far more powerful than most calculators but can require that you understand what is happening. It should also be clear why a special fraction button was not provided: the 'fractions' are never actually stored or manipulated as fractions at all!



As you can see in the screenshot right, a setting of Fraction 4 produces a strange (but actually correct) result for 0.666, while adding one more 6 (to take the decimal beyond 4 d.p.) will give the desired result of  $2/3$ . In other words, so long as you understand the approach taken by the hp 39g+ it is capable of producing results which are closer to what was probably intended by the user in entering 0.66666.

If you want to use this facility to convert decimals to fractions, here are some tips...

- if you are converting a recurring decimal to a fraction, then make sure you include at least one more digit in the decimal than the setting of Fraction in **MODES**. As you can see in the second screenshot, failing to include enough decimal places does not produce the desired result.
- if you are converting an exact decimal to a fraction, then set a Fraction n value of at least one more than the number of decimal places in the value entered. Both examples right were done at Fraction 6.

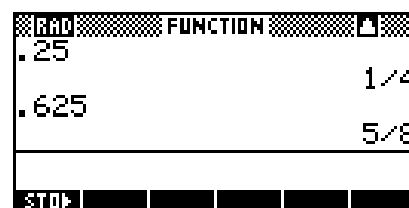
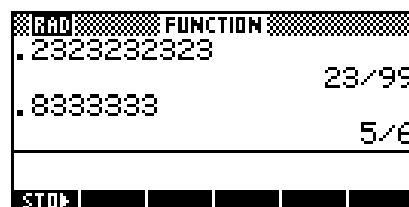

Not understanding the significance of the setting of Fraction can produce some unfortunate effects. For example, at Fraction 2, the value of 123.456 becomes 123, with the 0.456 dropped entirely.

Similarly, one of the earlier examples at the top of the previous page was  $1/3 + 4/5 = 17/15$ .

If you use a setting of only **Fraction 2** to perform this, you will find to your amazement that  $1/3 + 4/5 = 8/7$ , whereas using **Fraction 6** gives the correct answer.

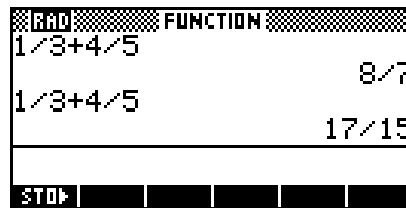

The reason for this 'error' is that the  $1/3$  and  $4/5$  were converted to decimals and added to give  $1.133333\dots$ . This was converted back to a fraction to give  $8/7$  ( $1.1428\dots$ ) matching sufficiently closely in **Fraction 2** to be accepted.

## The HOME History

The **HOME** page maintains a record of all your calculations called the History. You can re-use any of the calculations or their results in subsequent calculations.

Try this for yourself now. Type in at least four calculations, pressing the **ENTER** key after each one to tell the calculator to perform the calculation.

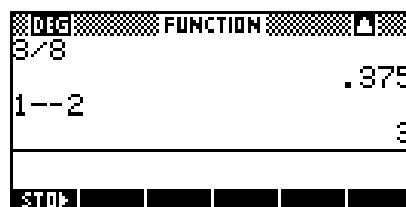

You will now be looking at a screen similar to the one on the right (except probably with different calculations).

If you now press the up arrow key, a highlighted bar moves up the screen. When you reach the top of the screen the previous calculations will scroll into view. Pressing **SHIFT** up-arrow takes the highlight to the top in one movement.



You may have noticed that as soon as the highlight appeared so did two labels at the bottom of the screen. If you now press the screen key under **COPY** you will find that the highlighted calculation will be copied on the edit line. This is shown in the screen shot on the right.

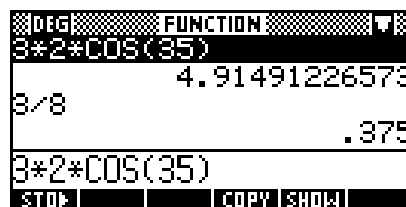

At this point you can use the left and right arrows and the **DEL** key to edit the calculation by removing some of the characters and/or adding to it.

For example, in the screenshot right, the calculation of  $3*2*\text{COS}(35)$  has been edited to  $3*\text{COS}(35)$ .

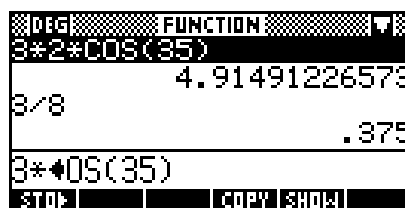

Pressing enter will now cause this new calculation to be performed.



### Calculator Tip

- Pressing **ON** during editing will erase the whole line.
- Pressing **SHIFT CLEAR** erases the whole history. This is worth doing regularly, since the history uses memory that may be needed for other things, even with the immense amount of user memory the hp 39g+ has.
- You can **COPY** calculations and results from any number of different lines in building your new expression.

Next to the **COPY** key you will see another screen key labeled **SHOW**. This key will display an expression the way you would write it on the page rather than in the somewhat difficult to read style that is forced on the calculator when it must show the whole expression on one line. This works anywhere the **SHOW** label appears, not just in **HOME**. Some examples...

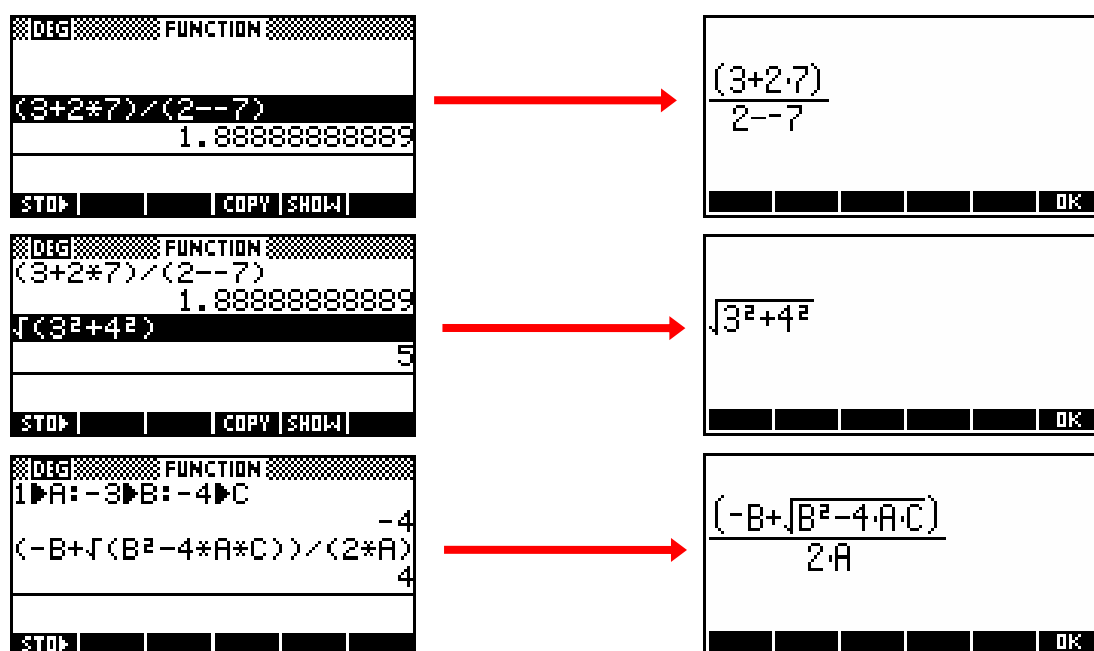

## Storing and Retrieving Memories

Each of the alphabetic characters shown in orange below the keys can function as a memory. Some examples of this are shown in the third and fourth examples above where the values of 1, -3 and -4 are stored into A, B and C and the value of 3 is stored into X. All of this 'storing' of values is done with the **STO** key, which is one of the screen keys listed at the bottom of the **HOME** view. There are ways of obtaining even more memories than these 26 alphabetic ones, such as storing values into a list (see page 176), but 26 is enough for most people.

Once stored into memory, a value can be used in a calculation by typing the letter into the place where you would normally use the value. Typing a letter and pressing **ENTER** will display memory's contents.



There is an advantage to storing results in memories, particularly if they are long decimals, or if you're going to be re-using the result a number of times.

As an example, we will perform the calculation of  $2 + \frac{4 \times (-3)}{2 \cdot 3 - 5}$ .

We will do this in two stages, calculating the top and bottom of the fraction and storing the results in memories.

Firstly the top of the fraction, storing the result in memory A, then the bottom, storing in B.



And then finally the result...



## Referring to other aplets from the HOME view.

Once functions or sequences have been defined in other aplets, they can be referenced in the HOME view.

- e.g. 1 Suppose we use the Function aplet to define  $F1(X)=X^2-2$  and  $F2(X)=e^X$  as shown right.

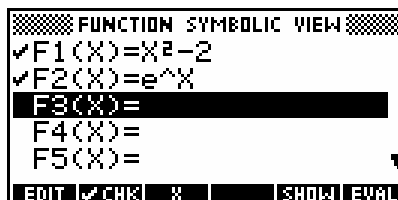

These functions now become accessible not only from within the HOME view but also within any other aplet also. This is shown by the screen shots below.

The results shown will (of course) depend on your settings in the MODES view.

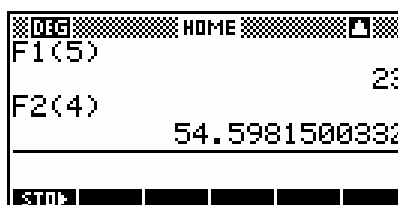

The reason for the QUOTE(X-2) rather than just X-2, is that using X-2 would tell the calculator to use the value currently stored in memory X, while QUOTE(X-2) tells it to use the symbol. The QUOTE function is available through the MATH menu under Symbolic (see page 257).

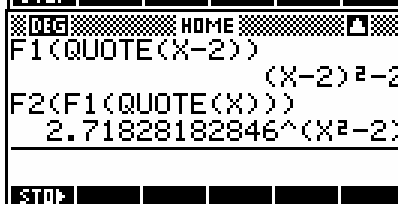

This type of work is actually *far* more easily done in the Function aplet, where QUOTE is not needed and the EVAL key does a better job. See page 71.

- e.g. 2 Suppose we use the Sequence aplet to define a sequence with

$$T_1 = 3, T_2 = 1 \text{ and } T_n = 2T_{n-1} + T_{n-2} .$$

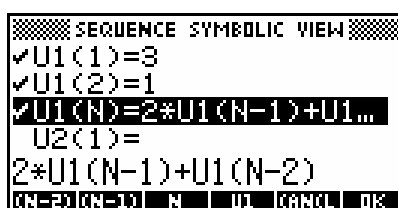

In the HOME view, the sequence values can be referred to as easily as the function values in the previous example.



## An introduction to the MATH Menu

The **MATH** menu holds all the functions that are not used often enough to be worth a key of their own. There is a very large supply of functions available, many of them extremely powerful, listed in their own chapter later in the book. When you press the **MATH** key you will see the pop up screen shown right. The left hand menu is a list of topics. Scroll through the topics until you find the one you want, then use the right arrow key to move into the list of functions for that topic.

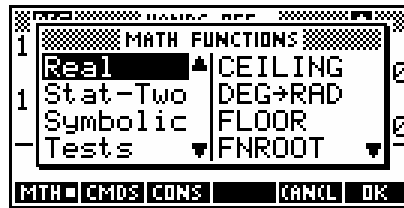

For example:

The function **ROUND** will round off to a specified number of decimal places.

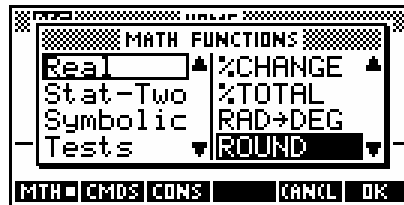

E.g. round off 145.25667 to 3 decimal places.

- Press the **MATH** key & right arrow (→) into the **Real** group of functions.
- Press the '**R**' key (the **9** key) to move to the first of the functions beginning with '**R**', then move down one more function to **ROUND**. Press **ENTER**.
- Now finish off the command and press **ENTER** again to see the result.

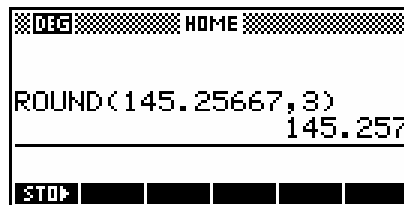

See page 243 for a far more detailed look at the Math Menu.

## ***Resetting the calculator***

It is probably inevitable as the line between calculators and computers becomes blurred that calculators will inherit one of the more frustrating characteristics of computers: they crash! If you find that the calculator is beginning to behave strangely, or is locking up then there are a number of ways to deal with this.



### **Calculator Tip**

If you are a user of external aplets then you may find that one will stop working with the message "Invalid syntax. Edit program?". There is almost certainly nothing wrong. Press **NO**, try a soft reboot as below, then run the aplet again.

### ***Soft reboot***

Pressing **ON+SK3** will perform a soft reboot. It is perfectly safe and will not cause any memory loss except that your **HOME** History will be cleared. Hold down the **ON** key and, while still holding it down, press the 3<sup>rd</sup> screen key from the left. The calculator will very briefly display a boot screen and then redisplay the **HOME** view, with the Function aplet as the active one.



Just on the rare chance that you may find that the calculator locks up so completely that the keyboard will not respond a method of reset is provided which is independent of the keyboard. This should never happen but it is important to know how to deal with it in case it happened during a test or an exam.

#### ***Soft reboot (Hardware)***

On the back of the calculator is a small hole. Poke a paper clip or a pin into this hole and press gently on the switch inside. To the calculator this is exactly equivalent to a soft reboot as outlined on the previous page. If you do this when the calculator is locked up then the chances are that you will find that the procedure will not only unlock the calculator but retain your data intact.

#### ***Hard reboot (with memory wipe)***

To completely wipe the calculator's memory press **ON+SK1+SK6**. Hold down the **ON** key and, while still holding it down, press the first and then the last screen keys. Release them in the opposite order. Don't release **SK1** and **SK6** together - release **SK6**, then **SK1**, then **ON**. This method will always cause complete loss of data. If you find that the screen fills with garbage, or if the calculator's in-built diagnostic routine starts to run, then it is just that you have not released them in the right order. Simply try again.



#### **Calculator Tip**

As a last resort, take the batteries out, including the disk shaped back-up battery and wait a few hours. Reinsert the batteries. Make **SURE** they go in correctly as you can very seriously damage the calculator if you insert batteries the wrong way around.

## Summary

1. The up/down arrow key moves the history highlight through the record of previous calculations. When the highlight is visible, the **COPY** key can be used to retrieve any earlier results for editing using the left/right arrow keys and the **DEL** key.
2. Care must be taken to ensure the your idea of order of operations agrees with the calculator's.  
For example,  $(-5)^2$  must be entered as  $(-5)^2$  rather than as  $-5^2$ , and  $\sqrt{5+4}$  must be entered as  $\sqrt{(5+4)}$  rather than  $\sqrt{5} + 4$ .
3. The **ANS** key can be used to retrieve the results of the calculation immediately preceding the one you're working on. E.g.  $\sqrt{(5+Ans)}$
4. The **DEL** key can be used to erase single lines in the history. The **SHIFT CLEAR** key will delete the entire history. Regular clearing will ensure that memory is not gradually eroded.
5. The **SHOW** key displays a calculation as you would see it written.
6. The **MODES** view can be used to set the format in which numbers are displayed on the **HOME** page, and to choose the angle measure which is to be used.
7. Make sure you understand **Fraction** mode before using it. Remember that the angle and numeric mode settings may change if you change aplets in the **APLET** view.
8. Numbers are stored in memory using the key labeled **STO**. The stored values can then be used by simply putting the letter in the expression in place of the number.
9. You can reboot the calculator if it locks up. Make sure you know how to do this in case it happens during a test or an examination.

For more information on the complete set of mathematical functions available in the **HOME** view (and anywhere else) see the chapter "The MATH menu" on page 243.

## THE FUNCTION APLET

The Function applet is probably the one that you will use most of all. It allows you to:

- [graph equations](#)
- [find intercepts](#)
- [find turning points \(maxima/minima\)](#)
- [find areas under curves](#)
- [find areas between curves](#)
- [find gradients](#)
- [find derivatives algebraically](#)
- [find simple integrals algebraically](#)
- [evaluate functions at particular values](#)
- [graph and evaluate algebraically expressions such as  \$f\(g\(x\)\)\$  or  \$f\(x+2\)\$](#)

The first step for any applet is to choose it in the **APLET LIBRARY**. Press the **APLET** key and you will see something similar to the screen on the right. Use the arrow keys to move the highlight up or down until the Function applet is selected. Now, looking at the list of programmable functions at the bottom of the screen, you should see labels of **START** and **RESET**.



Press the key under **RESET** first. You'll see the message shown right - press the **YES** key. The reason for doing this is to clear out any functions that you may have put in there while playing around, and so to make sure that what you see will be the same as the screen snapshots.



Now press the **START** key. When you do, your screen should change so that it appears like the one on the right. This is the **SYMB** view. Notice the screen title so that you will know where you are (if you didn't already).

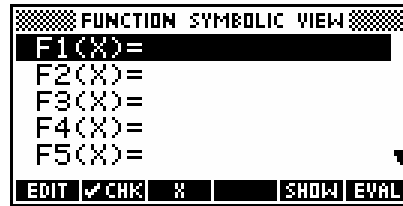



**Calculator Tip**  
 Pressing **ENTER** here would have had the same effect. Whenever there is an obvious choice pressing **ENTER** will usually produce the desired effect.

### The XTθ button

Whenever you enter an aplet, one of the keys which usually changes its function is the key labeled **XTθ**. As its label suggests, it supplies an X, or a T, or a θ, depending on which aplet you are in. Let's use that key to produce a graph of the quadratic we dealt with in the earlier section on the **HOME** view.

Using the up/down arrows, move the cursor (if necessary) to the line  
 F1(X) = .

Type in:

3   - 5  - 4

This will produce the screen shown on the right. Notice the check/tick mark next to the function F1(X). This signifies that this function is to be graphed, so that if you had five functions entered but only wanted numbers 1, 3 and 4 graphed, you could simply ensure that only F1(X), F3(X) and F4(X) were checked.

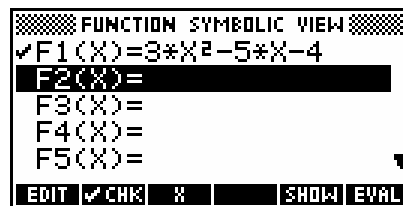

### CHKing your function

The key that turns the check on or off is a screen key - the one labeled with the  **CHK**. It is a *toggle key* - when the check is off it turns it on and when on it turns it off. In some countries a 'check' mark is called a 'tick' mark but the idea is the same.

Try turning the check on and off for function F1(X). Remember, the highlight has to be on the function before the check can be changed. Make sure it's checked when you have finished.

If you now press the **NUM** key, you will see the screen on the right. It shows the calculated function values for F1(X), starting at zero and increasing in steps of 0.1

X	F1		
0	-4		
0.1	-4.47		
0.2	-4.88		
0.3	-5.25		
0.4	-5.58		
0.5	-5.87		
0.6	-6.12		
0.7	-6.33		
0.8	-6.50		
0.9	-6.63		
1	-6.72		

NUM SETUP

ZOOM      BIG   DEFN

Make sure the highlight is in the X column, and then press **4** and **ENTER**. You will find that the numbers will now start at 4 instead of zero. It is also possible to change the step size via the **ZOOM** key, which can be convenient at times, particularly for trig functions. The simplest way to set the start value and increment is in the **NUM SETUP** view. This will be covered in detail later (see page 77).

Now try pressing the **PLOT** key. The graph you'll see will not be a terribly useful one (see right) because the axes will not be set up correctly. We'll look next at how to do this.

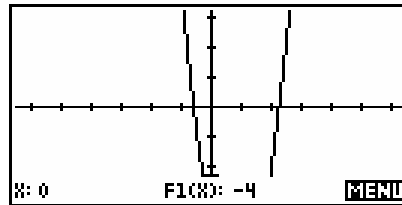

One of the easiest ways to set up the axes properly for a function whose shape is not known in advance is to let the calculator suggest a suitable scale. There are a number of ways of doing this. See page 86 for a discussion of ways of finding 'nice' axes.

One method of finding a viable scale is to use the *Auto Scale* option in the **VIEW**s menu (below). More information on the **VIEW**s menu can be found on page 92. Another method is to use the **NUM** view to investigate the range of values that will be required for the function.

## Auto Scale

Press the **VIEWS** key. Use the arrow keys to scroll down to *Auto Scale* and press **ENTER**. The calculator will adjust the y axis in an attempt to fit as much of the graph on to the screen as possible.



Some points to bear in mind;

- the y axis is scaled only on the first function which has a  **CHK**.
- the y axis is scaled for the x axis you have chosen in PLOT SETUP. If you've not chosen wisely then your result will not be good.
- it doesn't choose 'nice' scales such as we would choose (going up in 0.2's or 5's or 10's etc.) so we generally need to tidy up its choice a little.

If you look at the y axis of the graph you've just produced, you'll see that the axis tick marks are so close together that it looks like a solid line! To tidy this up you must change to the **PLOT SETUP** view. If you look above the **PLOT**, **SYMB** and **NUM** keys you will see the word '**SETUP**'. The **SETUP** view for each of these keys is obtained via the **SHIFT** key.

See "Tips & Tricks - Function" on page 69 for more information on how to find good choices for axes. The Auto Scale function is covered in much greater detail on page 96.

## The PLOT SETUP view

If you press **SHIFT** then **PLOT** you will see something like the view on the right.

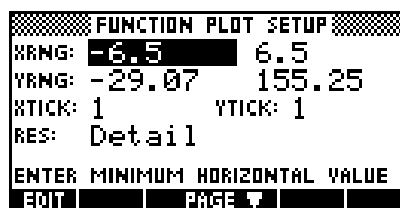

The highlight should be on the first value of 'XRng:'. Enter the value **-4**.



### Calculator Tip

Don't use the subtract key to input a negative. You **MUST** use the negative key labeled (-) which is in the same row as the **ENTER** key.

Type in **4** for the other 'XRng:' value, then **-20** and **20** for the 'YRng:' values. When you've done this use the arrow keys move to 'Ytick:' and change it to **5**.

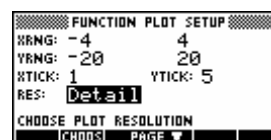

At the bottom of the screen you will see *Res:* (short for 'Resolution'). If you highlight it and press the **CHOOS** key you will see that you have a choice of *Faster* or *More Detail*. *More Detail* should be selected. If you choose *Faster* then every second dot is plotted instead of every dot. This is quicker but may make some graphs appear less smooth, particularly graphs with steep gradients.

There are two pages to this view (see the **PAGE** key at the bottom of the screen). The first page is used to set axes, the second to control certain features of them.

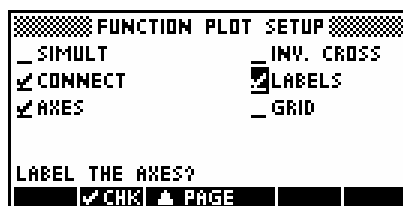

Press the **PAGE** key. You will now be looking at the screen shown above right. Using the arrow keys to move the highlight, make sure that your checks/ticks match the ones in my snapshot. Now press **PLOT** again. Perfect!

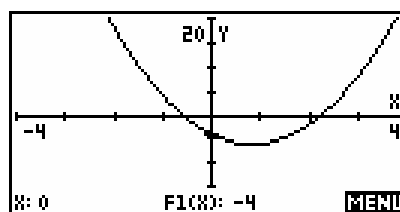

Let's have a look at the meaning of the CHks (check marks) on the second page of **PLOT SETUP**. Although they are not used often they can be quite useful and I recommend highly that you use *Simult*:

The first option *Simult*: controls whether each graph is drawn separately (one after the other) or whether they are all drawn at the same time, sweeping from left to right on the screen.

My preference is to turn this off. I find that if there are more than two functions defined then drawing them all at the same time can be confusing. Turning off *Simult*: means that they are drawn one after the other, in the order that they are defined. This is obviously a bit slower.

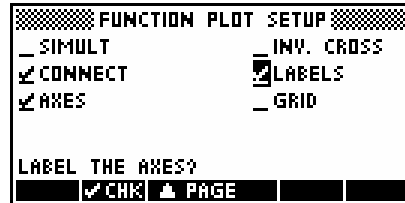

The second option *Connect*: controls whether the separate dots that make up a graph are connected with lines or left as dots.

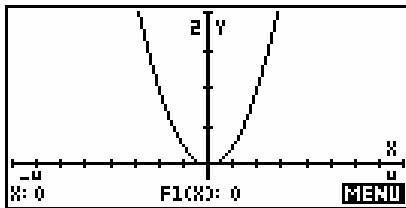

VS...

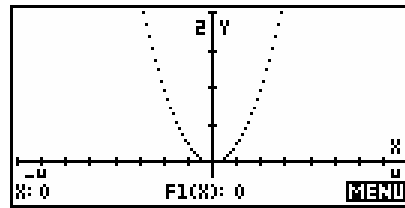

The third option *Axes*: controls whether axes are drawn. The fourth *Inv.Cross*: controls the appearance of the cursor that is moved by the arrow keys. It is best if you try this one yourself to see the effect.

The fifth option *Labels*: controls whether labels (X, Y and numbers) are put on the axes. The only time this causes problems is if the scale is an odd one, causing the labels to have too many decimal places.

The sixth and last check *Grid*: causes a grid of dots to be drawn on the screen (see right). The density of the grid is controlled by the values of Xtick and Ytick. This can be quite useful.

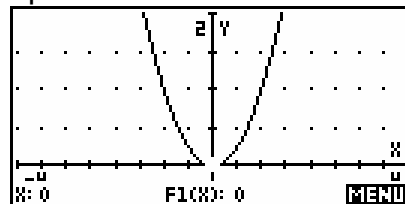



## The default axis settings

The default scale is displayed in the **PLOT SETUP** view shown right. It may seem a strange choice for axes but it reflects the physical properties of the LCD screen, which is 131 pixels wide by 63 pixels tall. A 'pixel' is a 'picture element' and means a dot on the screen. The default scale means that each dot represents a 'jump' in the scale of 0.1 when tracing graphs. The y value is determined by the graph, of course, and has nothing to do with your choice of scale. Once the scale changes, the cursor jumps from dot to dot are often not a useful size. See page 69 for information on choosing 'nice' scales.

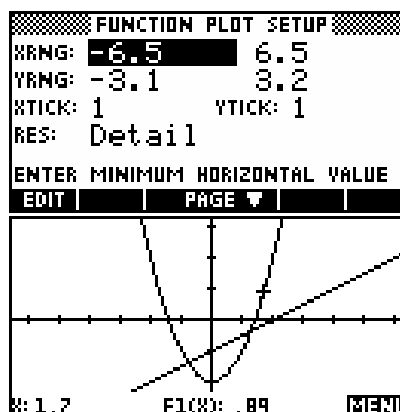

## The **MENU** Bar

If you look at the screen key list at the bottom of the screen you will see only a single entry, labeled **MENU**.

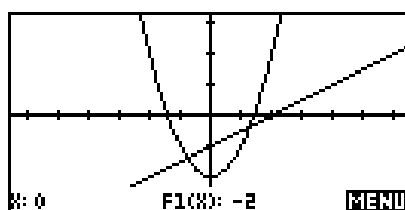

Press the key under it and your screen will change to look like the one above right.

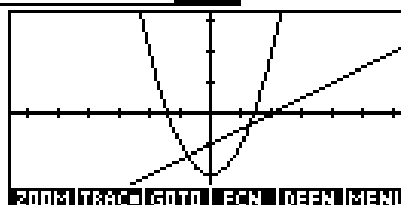

Press it again and the screen will clear completely. Once more and you are back to the original appearance. Try pressing it a few times to get the feel for its behavior. This is what is known as a 'toggle' switch. The **MENU** key is a triple toggle, cycling through each of the display modes shown right. The first default mode is (X,Y) mode, which displays the coordinates of the current cursor position. In any of these modes the up/down arrows move the cursor from function to function, while the left/right arrows move along the currently selected function.

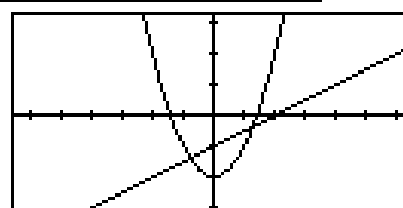

### Calculator Tip

Pressing **SHIFT** right arrow or **SHIFT** left arrow will jump the cursor directly to the right or left side of the screen.

## The Menu Bar functions

In the examples and explanations which follow, the functions and settings used are:

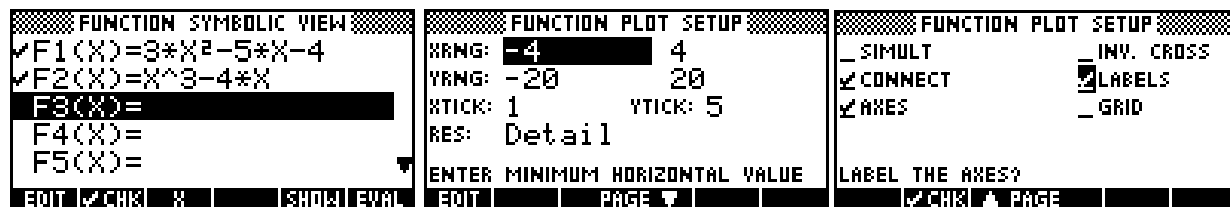

### Trace

**TRAC** is quite a useful tool. The dot next to the word means that it is currently switched on. If yours isn't then press the key underneath to turn it on. Leave it on for now.

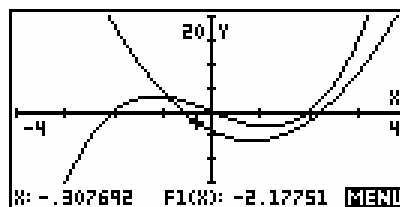

Press the left arrow 5 or 6 times to see a similar display to that shown right. Pressing up or down arrow moves from function to function.

The order used is not related graph but solely to the order that they are defined in the **SYMB** view. If it is turned off then the cursor is free to move anywhere on the screen. Try this and then turn it on again.

### Defn

Press the key labeled **DEFN** (short for *Definition*). You will find that the equation is now listed at the bottom of the screen.

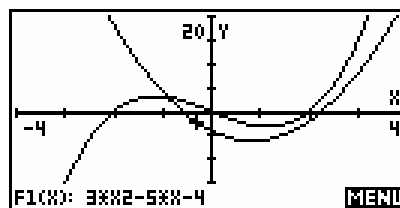

The up/down arrows will move the cursor from F1(X) to F2(X), with the definition changing as it does so. If Trace is switched off then Defn will not work correctly.

## Goto

This function allows you to move directly to a point on the graph without having to trace along the graph. It is very powerful and useful.

Suppose we begin with the cursor at  $x=0$  on  $F1(X)$  as shown right.

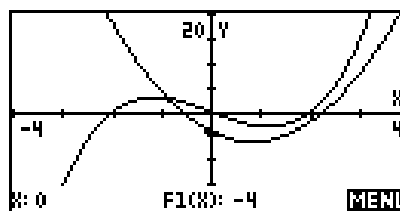

Press **MENU** and then **GOTO** to see the input form shown right.



Type the value 3 and press **ENTER**. The cursor will jump straight to the value  $x = 3$ , displaying the  $(X,Y)$  coordinates at the bottom of the screen.

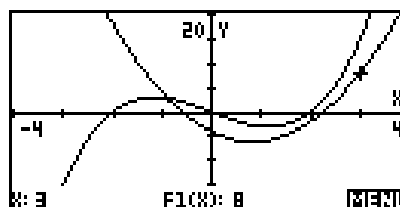

A very nice feature of the **GOTO** key is that it will jump to values which are not on the current screen, or which would be inaccessible for the current scale.

For example, we can jump to the value  $x = 100$  and see the  $(X,Y)$  coordinate displayed, with the cursor positioned at the far right side of the screen.

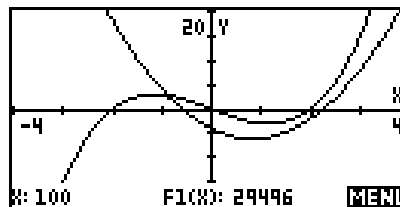

If the left arrow is now pressed, tracing will resume from the right edge of the screen, in this case at one pixel point back from  $x = 4$ .



### Calculator Tip

The **GOTO** key will also accept calculated values. You could, for example, jump to a value such as  $e^2+2$ . If you had recently found an intersection, then jumping to a value of **Isect** would return the cursor to that point. See page 64 for information on **Isect**.

### The Zoom Sub-menu

The next menu key we'll examine is **ZOOM**. Pressing the key under **ZOOM** pops up a new menu, shown right.

The menu is longer than will show in one screen, so two screen shots have been included to show most of the menu.

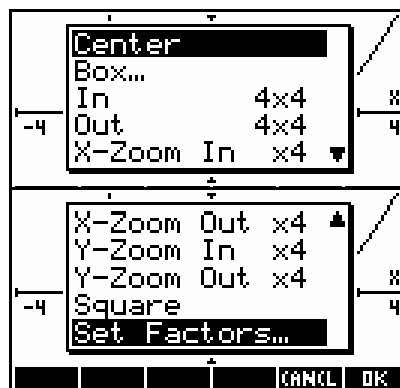

The list which follows covers the purpose of each of the ten options shown right. The four extra options which follow these are covered as part of the detailed examination of the **VIEWS** menu on page 92.

#### Center

This redraws the graph with proportionally the same scale for each axis but re-centered around the current position of the cursor. If you already have a 'nice' scale, this will preserve it, while perhaps showing a more interesting section of graph.

#### In/Out

These two options zoom in or out by adjusting the scales by the factor shown. The default factor is 4x4 but this can be adjusted through the *Set Zoom Factor* option later in the menu. The most useful settings are either 5x5 or 2x2 as these are more likely to give and preserve 'nice' scales.

### Box...

This is the most useful of the **ZOOM** commands. When you choose this option a message will appear at the bottom of the screen asking you to *Select first corner*.

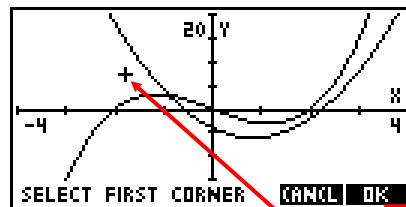

The cursor positioned at one corner of a

If you use the arrow keys to move the cursor to one corner of a rectangle containing the part of the graph you want to zoom into and then press **ENTER**, the message will change to *Select second corner*.

As you move the cursor this time to a position at the diagonally opposite corner of a box, the box will appear on the screen.

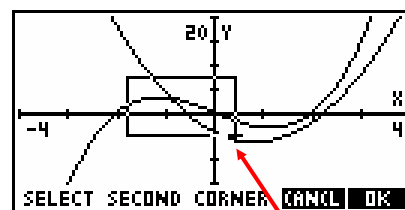

...and at the other corner.

Pressing **OK** expands the box to fill the screen.

You'll notice that the scale has been disrupted so that the labels are no longer very helpful. **PLOT SETUP** would give better end points for the axes or let you switch off the labels option.

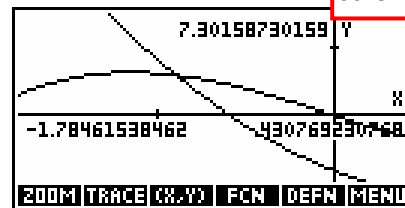

Rather than doing that however, scroll down the **ZOOM** menu to a new option of *UnZoom*. This option puts the screen back to the way it was before you did the **ZOOM**.



#### Calculator Tip

Zoom is very handy for allowing you to examine small sections of a graph in detail, but remember Un-Zoom!

### ***X-Zoom In/Out x4 and Y-Zoom In/Out x4***

These two options allow you to zoom in (or out) by a factor of 4 on either axis.

The factors can be set using the *Set Factors...* option, which gives you access to the view shown above right. You will also see a CHK mark next to an option called *Recenter*. If this is CHKed then the graph will be redrawn after zooming in or out with the current position of the cursor as its center.

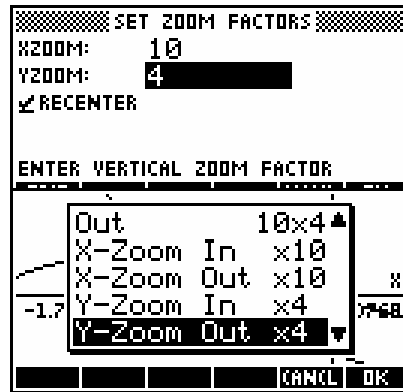

Changing the x factor is reflected in the **ZOOM** menu as you can see in the second screen snapshot.

### ***Square***

This option changes the vertical scale to proportionally match the horizontal scale so that circles will appear circular rather than elliptical.

### ***Auto Scale, Decimal, Integer and Trig***

These four options are duplicates of those found on the **VIEW** menu, and are provided in both places simply for convenience. Information on them can be found in the section on the **VIEW** menu on pages 92.

## The FCN menu

Before continuing, set the axes back to the way we set them at the start of the section on the Menu bar.

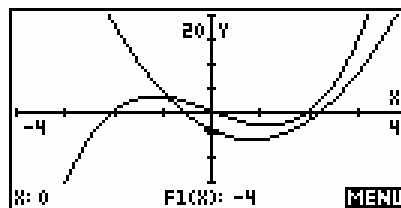

Looking at the menu functions again, you will see that the only one we have not yet examined is the one labeled **FCN**. This key pops up the Function Tools FCN menu.

Before you use this key, make sure **TRACE** is switched on and move the cursor so that it is in roughly the position shown right.

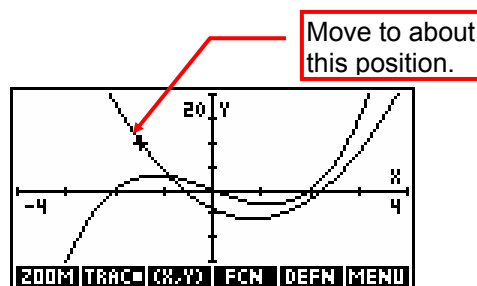

### Root

Press the **FCN** key. As you can see on the right, this key gives you access to a number of useful tools. If you leave the highlight on *Root* (as shown) and press **ENTER** (or **OK**) then the cursor will jump to the nearest root or x intercept for the function it is on, starting its search at the current position. Try it now.



Notice the message at the bottom of the screen giving the value of the root that was found. To find the other root, you need to move the cursor so that it is closer to the other root than to the present one. In general that means moving it past the turning point.

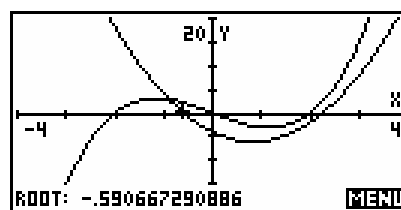

### Calculator Tip

If you are working with a function which has asymptotes then make sure the cursor is positioned on the same side of the asymptote as the root. The internal algorithm used does not seem to cope well with crossing asymptotes.

## Intersection

The next function tool in the **FCM** menu is *Intersection*. If you choose this option, then you will be presented with a choice similar to the one in the screen shown right.

Exactly what is in the menu depends on how many functions you have showing. In the case shown here we only have two, so the choice is of finding the intersection of F1(X), which is the one the cursor is on, with either the X axis, or the other function F2(X). The results of choosing F2(X) are shown right.

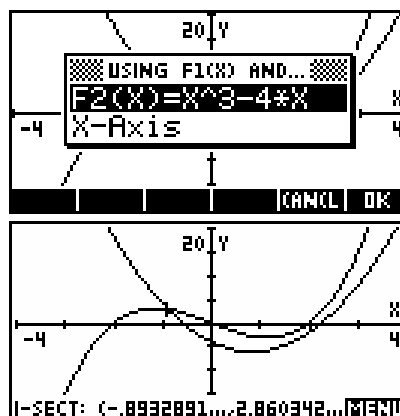

### Calculator Tip

When you find an intersection or a root the value of the x coordinate is stored in the memory X. If you immediately change to the HOME view and type X and hit ENTER then you can retrieve and use this value. See "Tips and Tricks - Function" on page 83 for more detail and examples.

## Slope

This gives the numerical value of the derivative at the point of the cursor for the current function.



### Calculator Tip

If the value at which you wish to find the slope is not accessible for the current scale then you will need to use the **EDIT** key to jump to the desired point before choosing *Slope*. The value is remembered and used in the *Slope* calculation, despite not being on the current scale. In the same way, choosing *Slope* immediately after finding a root or intersection will give the slope at the remembered value rather than the nearest dot.



### Signed area...

Another very useful tool provided in the **FCN** menu is the *Signed Area...* tool. Before we begin to use it, make sure that **TRAC** is switched on, and that the cursor is on F1(X) - the quadratic. The *Signed Area...* tool is similar to the Box Zoom in that it requires you to indicate the start and end points of the area to be calculated.

Suppose we want to find the definite integral:  $\int_{-2}^3 x^2 - 5x - 4 dx$

Choose **FCN** and then *Signed Area...* You will see the message shown right, asking you to choose a starting point.

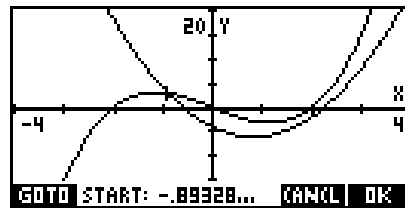

Press the **GOTO** key, enter the value -2 and press **OK** or **ENTER**. The starting value will then be -2 so press **OK** again (or **ENTER**) to accept it.

Another menu will appear, asking you to indicate what area you wish to calculate. In this case there are only two choices - between F1(X) and the X axis, or between F1(X) and F2(X).

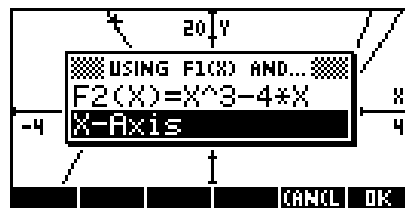

If we had defined more functions in the **SYMB** view then this menu would be longer. In this case we want the area between F1(X) and the x axis, so position the highlight as shown and press **ENTER**.

The graphs will then reappear, with a message requesting that you choose an end point. In the screenshot shown right I have pressed **GOTO** and entered the value 3 to move to that point directly.

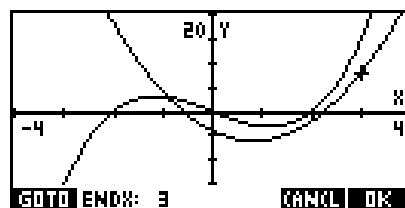

If you now press **ENTER** again to accept the end point, the hp 39g+ will calculate the signed area and display the result at the bottom of the screen.

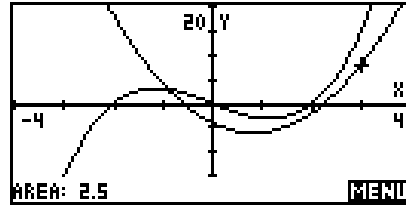

### Calculator Tip

It should be clearly understand that although the label at the bottom of the screen is **Area** it is a little misleading.

What has actually been calculated is the definite integral (right), with 'areas' below the x axis included as negatives. This is why the label on the original menu reads "*Signed area*" instead of just "Area".

$$\int_{\text{1st point}}^{\text{2nd point}} F1(X) dx$$

Rather than using the **GOTO** key, an alternative method is to use the tracing facility. The advantage of this is that the 'area' is shown visually as you go by shading, as can be seen right.

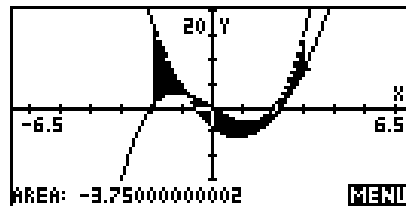

The disadvantage of this is that you can only trace to values which are permitted in the scale you are using. As soon as you use **GOTO** the shading stops. In this case, due to the scale we chose, if you try to trace to the values  $x = -3$  or  $x = 2$  you will find that they are not accessible so we will need to change scale.

Change to the **PLOT SETUP** view and change the x axis (only) back to  $-6.5$  to  $6.5$ , then **PLOT** again.

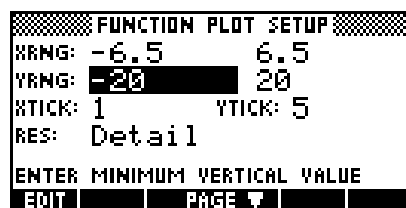

Press **MENU** and **FCN** again, choosing *Signed Area...* as before. Use the left/right arrow keys or the **GOTO** key to move the cursor to  $x = -2$ . Press **ENTER** to accept the starting point.

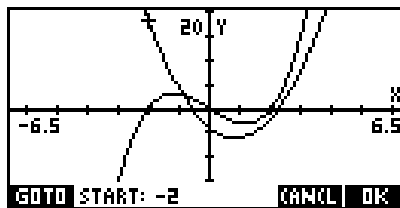

This time, choose the boundary as  $F2(X)$  instead of the  $x$  axis so that we will be finding the 'area' between curves instead of the area under one. Again, the result will be a signed area (definite integral) not a true area. See page 83 for a simple method of finding true areas.

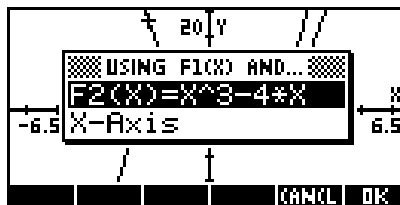

We now need to choose the end point. This time do it by tracing with right arrow to move the cursor. As you do the area will be shaded by the calculator. The current position is shown at the bottom of the screen. When you reach the end point you are looking for, press the **OK** key and the area will be calculated as before. This is shown right.

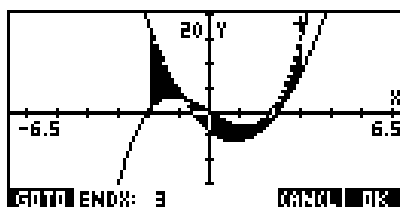

To remove the shading, press **PLOT** again.

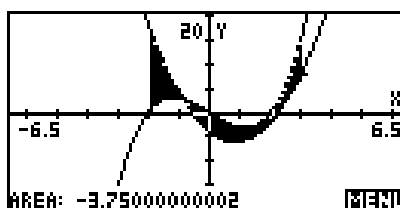

### Calculator Tip

Note that common sense tells us that the answer is almost certainly  $-3.75$  rather than  $-3.75000000002$ . The small error is simply due to accumulated rounding error in the internal methods used by the calculator. For example, an answer of  $0.4999999999$  should be read as  $0.5$ . This is quite common and students should be aware of the need for common sense interpretation.

### Areas between and under curves

If we are wanting to find true areas rather than the 'signed areas' given by a simple definite integral then we must take into account any roots of the function. This process is shown in detail on page 83, as there are certain tricks which can be used to make the process far simpler.

## Extremum

The final item in the **FCN** menu is the *Extremum* tool. This is used to find relative maxima and minima for the graphs.

Ensure that **TRAC** is switched on and that the cursor is positioned on the cubic  $F2(X)$  in the vicinity of the left hand maximum (turning point) as shown right. Press **FCN** and choose *Extremum* from the menu. You should find that the cursor will jump to the position of the maximum.

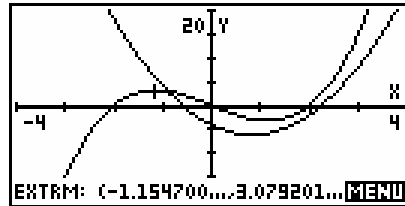

### Calculator Tip

If your graph has asymptotes then make sure that the cursor is positioned on the side of the asymptote containing the extremum before initiating the process. The internal algorithm used does not cope well with intervening asymptotes.

## TIPS & TRICKS - FUNCTION

### *Finding a suitable set of axes*

This is probably the most frustrating aspect of graphical calculators for many users and there is unfortunately no simple answer. Part of the answer is to know your function. If you know, for example, that your function is hyperbolic then that immediately gives information about what to expect. If you don't have knowledge then here are a few tips:

1. Try just plotting the function on the default axes. You may find that enough of the function is showing to give you a rough idea of how to adjust them to display it better. Remember that ZOOM can work on either axis or on both. See Tip #4 on the next page.
2. The **NUM** view can be very helpful. Try changing to **NUM SETUP** and setting the value of NumStep to 1, or even 5 or 10. Now scroll through the **NUM** view and look at what is happening to the  $F(X)$  values. Look for two things.  
Firstly, where is the function most active? For what domain on the x axis is it changing fastest? This is likely to be the domain you are most interested in.  
Secondly, what is the range? What sort of values will you need to display on the y axis?  
Now change to the **PLOT SETUP** view and set what you think may be appropriate axes. From those you can **PLOT** and then zoom in or out.
3. If the graph is part of a test or an examination then the wording of the question will often give a clue as to what x axis domain you should work with.
4. I most often use *Auto Scale* to get a first approximation to a good set of axes. To do this you must choose your x axis domain first so try Tip #2 above and use your knowledge of what the function might look like.

5. Another possible strategy for graphing which works quite well and, perhaps importantly, always gives 'nice' scales is to use ZOOM.

- Enter your graphs into the **SYMB** view. Remember that Auto Scale only works on the first ticked graph.
- Press **VIEWS** and choose *Decimal*, or press **SHIFT CLEAR** in the **PLOT SETUP** view. This will give you the default axes, probably not showing the graph very well.
- Place the cursor so that it is in the center of the area you are most interested in.
- Use the **ZOOM** menu to adjust the view. You may choose first to change the zoom factors to something other than 4x4, and to ensure that *Recenter:* is **CHKed**.

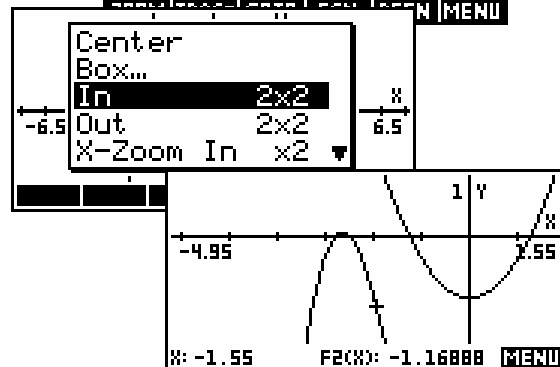
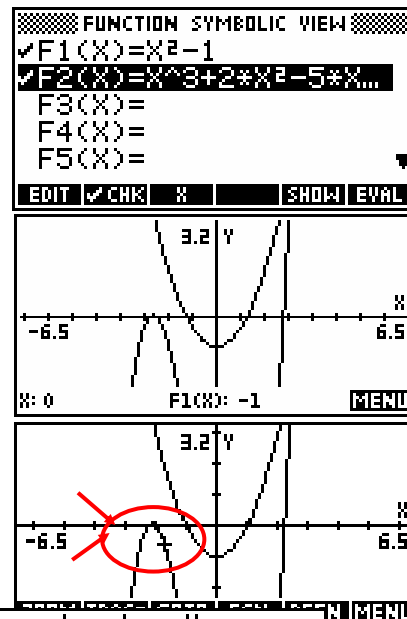

The advantage of doing it this way is that if you zoom in or out by a factor of 2 or 4 or 5, the cursor jumps will stay at (relatively) nice values allowing you to trace more easily. In this case, the cursor now moves in jumps of 0.05, which is ideal for most purposes. On the other hand you may not be interested in tracing along the graph.

## Composite functions

The Function applet is capable of dealing with composite functions such as  $f(x+2)$  or  $f(g(x))$  in its **SYMB** view.

The **EVAL** and **SHOW** keys are particularly helpful with this.

For example, if we define  $F1(x) = x^2 - 1$  and  $F2(x) = \sqrt{x}$ , then we can use these in our defining of  $F3, F4$ . See the screen shot on the left below.

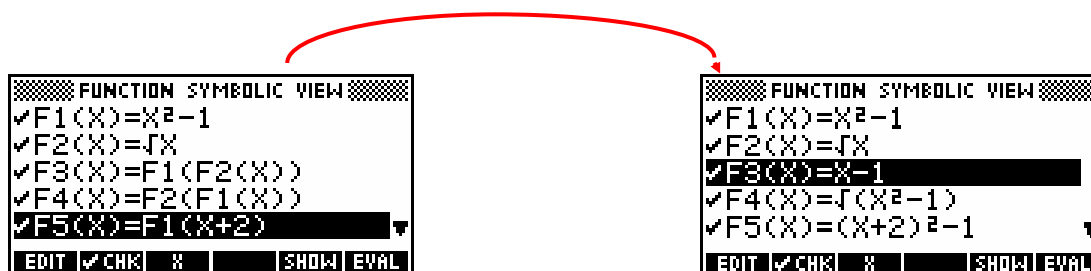

If the highlight is now positioned on each of these in turn, and the **EVAL** key pressed then the substitution is performed.

The result is shown in the upper right hand snapshot and the  $F4(X)$  function is shown right after pressing **SHOW**.

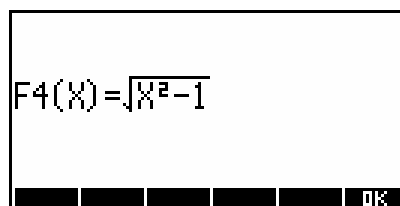

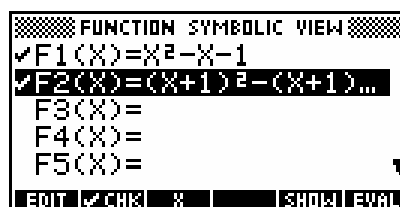

Notice that the calculator is smart enough to realize in  $F3(X)$  that  $(\sqrt{x})^2 - 1$  is the same as  $x - 1$ , although not, unfortunately, smart enough to keep track of the implications for the domain that  $F3(X)$  should be defined only for non-negative  $x$ .

There is a limit to this however. If you define  $F1(x) = x^2 - x - 1$  and then  $F2(x) = F1(x+1)$ , then the **EVAL** routine will not simplify  $(x+1)^2 - (x+1) - 1$  to  $x^2 + x - 1$ .

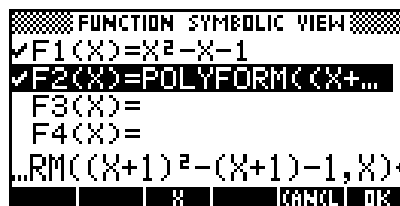

On the other hand there is a way to further simplify the expression. If you now **EDIT** the result and enclose it with the **POLYFORM** function as shown right (note the final ',X'), then highlight it and press **EWAL**, the hp 39g+ will expand the brackets and gather terms.





**Calculator Tip**  
 These functions can all be graphed but the speed of graphing is slowed if you don't press **EWAL** first. The 39G+ is fast enough that the result can be lived with but the 39G and 40G are usually too slow when graphing un-evaluated composite functions.

Evaluating the function may also hide the domain. For example, if  $F1(X) = X^2$  and  $F2(X) = \sqrt{X}$  then  $F3(X) = F1(F2(X))$  will show the correct domain of  $x \geq 0$  in the **NUM** view. Pressing **EWAL** will destroy this.

X	F1	F2	F3
-.3	.09	UNDEF.	UNDEF.
-.2	.04	UNDEF.	UNDEF.
-.1	.01	UNDEF.	UNDEF.
0	0	0	0
.1	.01	.3162278	.1
.2	.04	.4472136	.2
.3			

### Using functions in the HOME view

Once functions have been defined in the **SYMB** view of the Function apilet, they can be reused in the **HOME** view (and indeed in any other apilet!).

For example suppose you needed to find some exact points ( $x = 0, 1, 2$  and  $3$ ) for a graph of  $f(x) = \frac{2x}{(x-2)}$  when doing a hand sketch of it.

Type its definition into the Function apilet **SYMB** view, switch to the **HOME** view and then simply type  $F1(0)$  and press **ENTER**. The function will be evaluated for  $x = 0$ . Similar results can be obtained for  $F1(1)$ ,  $F1(2)$  and  $F1(3)$ . Notice the error message for  $x = 2$  caused by a divide by zero.





## Differentiating

There are different approaches that can be taken to differentiating, most of which are best done in the **SYMB** view of the Function applet.

The syntax of the differentiation function is:

$$\partial X(\text{function}),$$

where *function* is defined in terms of X.

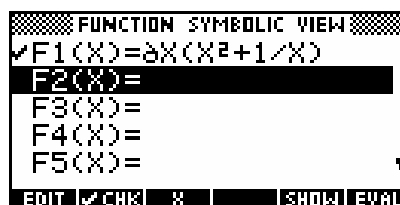

The function can either be already defined in the **SYMB** view of the Function applet, or entered into the brackets as above.

The  $\partial$  symbol most easily obtained by pressing the key labeled **d/dx**.

One point to remember is that if you use this function in the **HOME** view you may not receive the result you expect. If you try this yourself your result will probably not be the same as that shown.

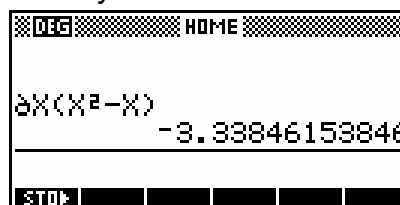

The reason for this is that the result you see is the derivative of  $x^2 - x$  evaluated at whatever value of  $x$  happens to be currently in memory. This can be seen more clearly if we store a specific value into the memory X beforehand. In the example shown right, the answer of 3 is the value of the derivative  $2x - 1$  at the value of  $x = 2$ .



But what of algebraic differentiation? It is possible but not very convenient to do this in the **HOME** view using a “formal variable” of S1. (.or S2 to S5) The drawback of this is simply the awkwardness of having to work with S1’s rather than with X’s.



The process is easiest in the **SYMB** view of Function. When done this way the result is algebraic rather than numeric. The best method is to define your function as F1 and its derivative as F2 (see below)...



...but you can also perform the whole process in one line.

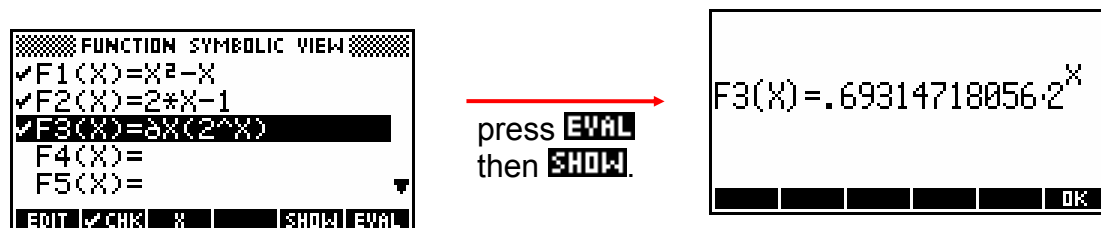

As you can see the calculator's algebraic abilities do not extend to differentiating  $f(x) = 2^x$  as  $f'(x) = \ln(2) \cdot 2^x$ , but at least it is numerically correct.



**Calculator Tip**  
 Doing your differentiation in the Function applet is much easier and offers the additional advantage of being able to graph the two functions.

### Circular functions

There are two issues that influence the graphing of circular functions, both related to the scale chosen.

The first one, illustrated on the right, causes circles to be ellipses if you don't choose scales for the x and y axes which are 'square' relative to each other. The two graphs above are both of the same function  $x^2 + y^2 = 9$ .

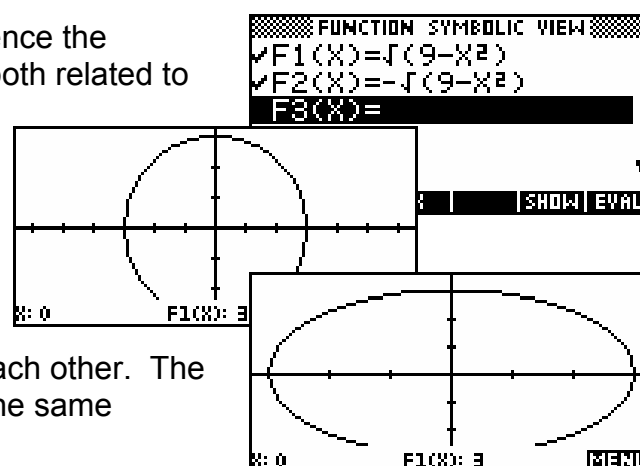

The simplest way to deal with this is to use scales which are multiples of the default scales. For example by using  $-13 \leq x \leq 13$  and  $-6.2 \leq y \leq 6.4$  (scale factor 2). You can also use the 'Square' option on the **ZOOM** menu. This adjusts the y axis so that it is 'square' relative to the x axis chosen.



The second issue is caused by the domain of the circle being undefined for some values. The screen on your calculator is made up of small dots called pixels and is 131 pixels wide and 64 pixels high. As was mentioned earlier, this means that each pixel is 0.1 apart on the x and y axes. This can affect your graphs and it becomes particularly obvious with circles because the graph does not exist for the part of the x axis outside the circle. The two screen shots right are an example of two images of the same graph  $x^2 + y^2 = 9$  using two slightly different scales. You can see that the second example has missing pieces.

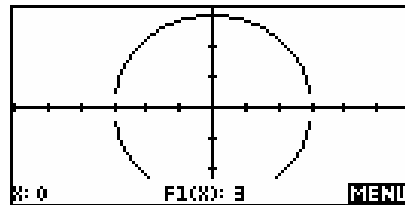
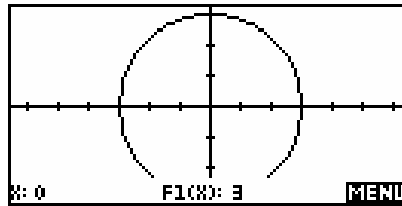

Let's look at the circle  $x^2 + y^2 = 9$  as an example. This circle only exists from -3 to 3 on the x axis and is undefined outside this domain. In order to graph it on the hp 39g+ you have to rearrange it into two equations of

$$F1(X) = \sqrt{9 - X^2} \quad \text{for the top half \&}$$

$$F2(X) = -\sqrt{9 - X^2} \quad \text{for the bottom half.}$$

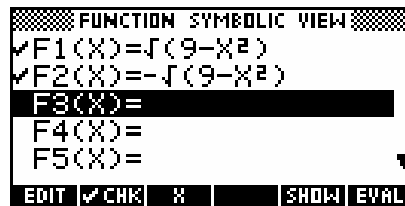

If you enter these equations and then graph them with the default axes then you get a perfect circle. However, if you change the x axis from the default setting to -6 to 6 and then re-PLOT then part of the circle disappears. This is shown in the snapshot at the start of the question.

The reason for this is that when the calculator draws the graph it does so by 'joining the dots'. For the default scale of -6.5 to 6.5 this is not a problem since the edges of the circle at -3 and 3 fall on a pixel. This means that the last segment of the graph plotted extends is from 2.9 to 3 and the circle reaches right down to the x axis.

However, for the scale of -6 to 6 the pixels are no longer 'nice' values of 0.1. If you try to trace the circle you'll see that the pixels fall on 0, 0.0923077, 0.1846154..... In particular, near x=3 the pixel values are 2.953846 and 3.046154. This means that the calculator can't draw anything past 2.953846 because the next value doesn't exist, being outside the circle. This is what causes the gap in the circle. There's nothing to join to past that last point.

The solution is to use scales which allow the end points of your circle to fall on a pixel point. If your circle has an integer radius then this is easily done by starting with the default axes and then **ZOOM** in or out to show the circle. This will tend to give 'nice' pixel points. If your circle is not centered on the origin then just check/tick the box in the *Set Zoom Factors* box to *Recenter*. That will allow you to turn off TRACE, move the cursor closer to the point where you'd like the centre of screen to be and then **ZOOM**.

### Trig functions

If graphing a trig function using radian measure then you should choose a scale which will cause pixel values (screen dots) to fall at convenient points. A good scale to use is provided on the **VIEW**s menu (see right).

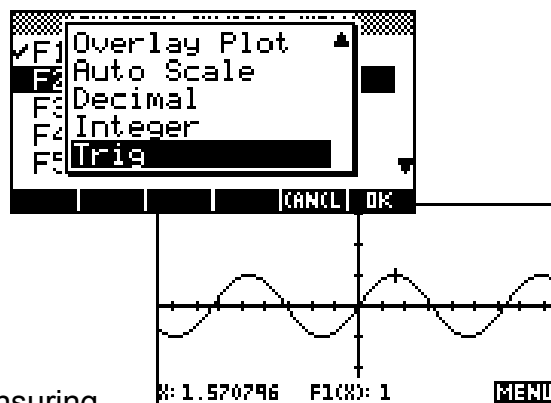

This scale sets each dot to be  $\frac{\pi}{24}$ , ensuring that multiples and most factors of  $\pi$  will fall on dots and thus helping if you want to trace values on the graph.

Ensure the angle measure is set to Radians in the **MODES** view if you intend to use this scale.

**Calculator Tip**  
 Make sure you set angle measure *after* you have **START**ed the aplet, not before, so as to ensure you are setting the correct aplet.

### Retaining calculated values

When you find an extremum or an intersection, the point is remembered until you move again even if it is not actually on a value that would normally be accessible for the scale you have chosen.

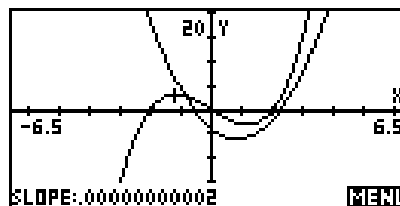

For example, if you find an intersection and then return to the **FCN** menu and choose *Slope*, the slope calculated will be for the intersection just found rather than for the nearest pixel point. If you have recently found a root then pressing the **FIND** key and entering the value **Root** will return the cursor to it.

There are two ways to access these values. The first and simplest is via the value stored in memory **X**. If you move from **PLOT** to the **HOME** view and type **X** (using **ALPHA**) then the value it will contain will be the last position of the cursor. If you just found a root or an intersection then this will be the value displayed. The second way is via the reserved words of **Root**, **Extremum**, **Area**, **Slope** and **Isect**. Typing any of these reserved words in any situation will retrieve their last calculated values. If a value has not been found yet then they will return zero.

This trick is particularly useful when calculating areas under or between curves. See page 83.

### The NUM view revisited

We saw earlier that the **NUM** view gives a tabular view of the function.

X	F1		
0	-1		
1	-.99		
2	-.96		
3	-.91		
4	-.84		
5	-.75		

At the bottom of the screen, there are three menu options: **ZOOM**, **BIG**, and **DEFN**.

It is possible to manipulate this view through the **NUM SETUP** view.

Firstly, one can change the start value and the step size for the view.

For example, values of 10 and 2 give:

FUNCTION NUMERIC SETUP	
NUMSTART:	10
NUMSTEP:	2
NUMTYPE:	Automatic
NUMZOOM:	4
ENTER INCREMENT VALUE	
EDIT	PLOT



X	F1		
10	.99		
12	1.43		
14	1.95		
16	2.55		
18	3.23		
20	3.99		
10			
ZOOM		BIG	DEFM

Looking at the **NUM SETUP** view you will see an entry called *NumType*: with the default value of *Automatic*. The only alternative to *Automatic* is the setting of *Build Your Own*. Under this setting the **NUM** view will be empty, waiting for you to enter your own values for X.

FUNCTION NUMERIC SETUP	
NUMSTART:	10
NUMSTEP:	2
NUMTYPE:	Build Your Own
NUMZOOM:	4
ENTER STARTING VALUE FOR TABLE	
EDIT	PLOT



X	F1		
EDIT	INS	SORT	BIG DEFM

Typing in the values of (for example):

**3 (ENTER) -2 (ENTER) 5 (ENTER)**

... will give...

X	F1		
3	.8		
-2	2.4		
5			
EDIT	INS	SORT	BIG DEFM

In this situation the function values are being calculated as you input the X values. This can be quite useful if you are wanting to evaluate the behavior of a function at selected points.

If you now use the **NUM SETUP** view to switch to *Automatic* you will find that there is a **ZOOM** key at the bottom left of the **NUM** view. This can be quite useful as a fast way to reset the scale.

X	F1		
0	-1		
.1	-.99		
.2	-.96		
.3	-.91		
.4	-.84		
.5	-.75		
ZOOM		BIG	DEFM

Pressing the **ZOOM** key pops up the menu on the right. The first option of *In* causes the step size to decrease from 0.1 to 0.025. This is a factor of 4 and is changeable via the **NUM SETUP** view. I find a zoom factor setting of 2 or 5 to be more useful.



The second option of *Out* causes the opposite effect, changing the step size upwards by whatever the Zoom Factor is set to.

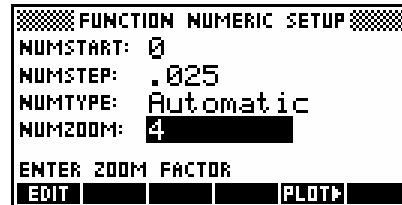

The *Decimal* option restores the default settings. It changes from whatever is showing back to the step size of 0.1. The *Integer* option on the other hand, changes the scale so the step size is 1.

The *Trig* option changes the scale so that the step size is  $\pi/24$  exactly. This will obviously be useful when dealing with trigonometric functions.

**Integration: The definite integral using the  $\int$  function**

The situation for integration is very similar to that of differentiation. The difference is that both the HOME view and the Function applet require the use of a “formal variable” S1. As with differentiation, the results are better in the Function applet. The  $\int$  symbol is obtained via the keyboard.

The syntax of the integration function is:

$$\int(a,b, function, X)$$

where:  $a$  and  $b$  are the limits of integration  
and  $function$  is defined in terms of  $X$ .

Let’s look first at the definite integral...

The screen left shows  $\int_1^2 x^2 + 1 \, dx = 3.3333\dots$

followed by  $\int_0^{\ln 2} e^x \, dx = 1$ .

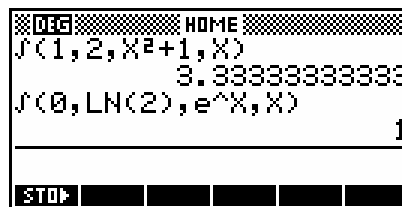

It may help you to remember the syntax of the differentiation and integration functions if you realize that they are filled in with values in exactly the same way that they are spoken.

E.g.  $\int_1^2 x^2 + 1 \, dx$  is read as:

“the integral from 1 to 2 of  $x^2 + 1 \, dx$ ”

& entered:  $\int ( \quad 1, \quad 2, \quad X^2 + 1, \quad X )$

A similar path was taken with the differentiation function, so that:

$\frac{d}{dx}[X^2]$ , which is read as “the derivative with respect to  $X$  of  $X^2$ ”

and entered  $\partial X(X^2) : \quad \partial \quad X \quad (X^2)$



## Integration: The algebraic indefinite integral

Algebraic integration is also possible (for simple functions), in the following fashions:

- i. If done in the **SYMB** view of the Function applet, then the integration must be done using the symbolic variable S1 (or S2, S3, S4 or S5). If done in this manner then the results are very good, except that there is no constant of integration 'c'.

The screenshot right shows the results of defining  $F1(X) = X^2 - 1$  and then

$$F2(X) = \int(0, S1, X^2 - 1, X),$$

together with the results of the same thing after pressing the **EVAl** key (the result is placed in F3 only for convenience of viewing). All

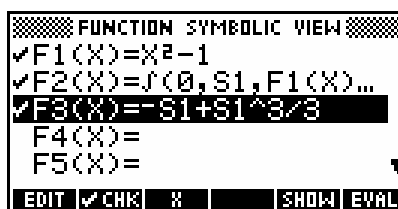

that is now necessary is to read '-S1+S1^3/3' as  $-x + \frac{x^3}{3}$ , or as it

should be read as  $\frac{x^3}{3} - x + c$ .

- ii. If done in the **HOME** view, then S1 must again be used as the variable of integration.

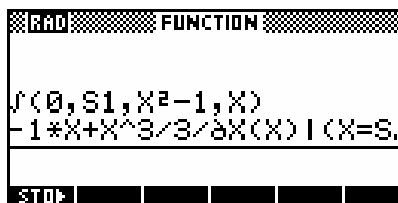

i.e.  $\int x^2 - 1 dx$  is entered as  $\int(1, S1, X^2 - 1, X)$ .

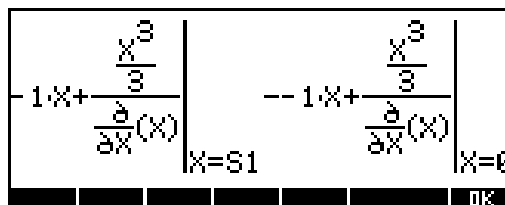

This is shown right, together with the results of highlighting the answer and pressing **SHOW**. The calculator assumes that X itself may be a function of some other variable and integrates accordingly as a 'partial integration' which, while mathematically correct, is not what most of us want.

The way to simplify this answer to a better form is to highlight it, **COPY** it, and press **ENTER** again, giving the result shown right. This is the result of the calculator performing the substitutions implied in the previous expression.

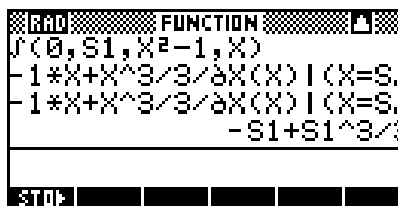

This substitution process has one implication which you need to be wary of and so it is worth examining the process in more detail...

$$\begin{aligned} \int_0^{S1} x^2 - 1 dx &= \left[ \frac{x^3}{3} - x \right]_{x=0}^{x=S1} \\ &= \left( \frac{S1^3}{3} - S1 \right) - \left( \frac{0^3}{3} - 0 \right) \\ &= \frac{S1^3}{3} - S1 \end{aligned}$$

The potential problem lies with the second line, where the substitution of zero results in the second bracket disappearing. This will not always happen.

For example...

$$\begin{aligned} \int_0^{S1} (x-2)^4 dx &= \left[ \frac{(x-2)^5}{5} \right]_{x=0}^{x=S1} \\ &= \left( \frac{(S1-2)^5}{5} \right) - \left( \frac{(0-2)^5}{5} \right) \\ &= \frac{(S1-2)^5}{5} - 6.4 \end{aligned}$$

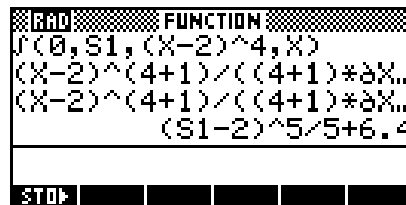

The final constant of 6.4 comes from substituting zero into the expression and should not be there if we were doing this with the aim of finding an indefinite integral. On the other hand, we all know that the answer should have a constant of integration, so perhaps this extra constant will help you to remember the '+c'!

In addition to this, there are strict limits to what the hp 39g+ can integrate.

For example, if you try to evaluate  $\int \sin^2 x \cdot \cos x dx$  using the calculator, it will not be able to do it. Essentially, beyond polynomials forget it.

### **The hp 40g Computer Algebra System**

Owners of the hp 40g will be aware that it has a CAS which allows it to perform the most complex algebra, including complex integrations, with ease. More information on the CAS can be found in the supplementary appendix on the hp 40g. See the Table of Contents.

## Integration: The definite integral using PLOT variables

As was discussed earlier, when you find roots, intersections, extrema or signed areas in the PLOT view, the results are stored into variables for later use.

For example, if we use **FCN** Root to find the x intercept of  $f(x) = x^2 - 2$  then the result is stored into a variable called **Root**, which can be accessed anywhere else. Similar variables called **Isect**, **Area**, and **Extremum** are stored for the other **FCN** tools.

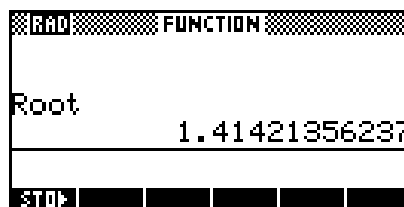
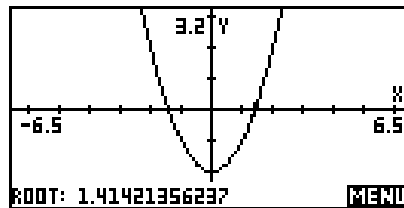

You can access these names by typing them in using the **ALPHA** key, or by using the **VARS** key. Press **VARS** and you will see a list of the **HOME** variables.



If you press SK2, labeled **APLET** (not the APLET button on the keyboard), then the display changes to show the variables specific to whatever aplet you are currently using. Those shown right are for the Function aplet and the group of *Plot FCN* variables is shown.

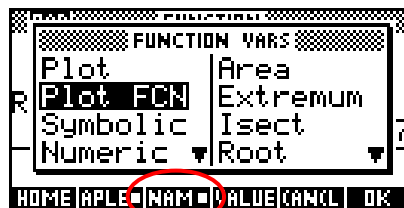

If you look at the screen shot you will see that the **NAME** tag is currently selected (showing as **NAME**) and this means that when you press **OK** the name of the variable will be pasted into what ever view you were using when you pressed the **VARS** key. Pressing the **VALUE** screen key will cause the *value* of the variable to be pasted instead. There is no effective difference in most situations.

This can be very useful in finding areas, as you will see in the example following.

Suppose we want to find the area between  $f(x) = x^2 - 2$  and  $g(x) = 0.5x - 1$  from  $x = -2$  to the first positive intersection of the two graphs. From the shaded screenshot shown above right it can be seen that to find the area we need to split it into two sections, with the boundaries being  $-2$  and the two intersections.

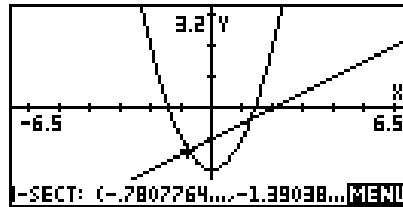
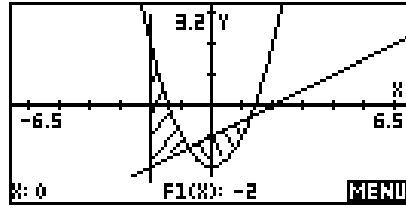

The shortcut here is to use **FCM** *Intersection* to find the first intersection, storing the results into memory variable **A**.



We then do the same thing for the second intersection, storing the result into **B**.

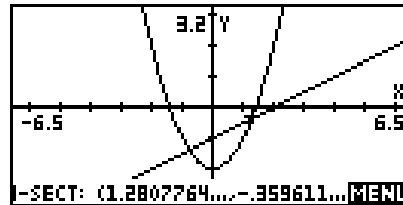

We can now calculate the area in the **HOME** view, using  $f_1 - f_2$  for the first and  $f_2 - f_1$  for the second. Use **COPY** to duplicate the first integral and edit it to adjust the functions and limits.

Finally, **COPY** the two solutions and add them to give the final answer.

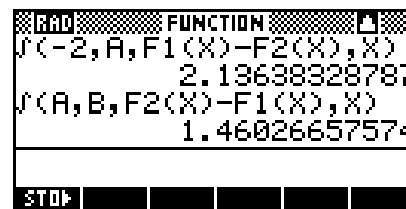

### Piecewise defined functions

It is possible to graph piecewise defined functions using the Function applet, although it involves literally splitting the function into pieces.

For example:  $f(x) = \begin{cases} x+3 & ; x < -2 \\ x^2 - 2 & ; -2 \leq x \leq 1 \\ 3-x & ; x \geq 1 \end{cases}$

To graph this we need to enter it into the SYMB view as three separate functions:

F1(X)=(X+3)/(X < -2)  
 F2(X)=(X<sup>2</sup>-2)/(X ≥ -2 AND X ≤ 1)  
 F3(X)=(3-X)/(X ≥ 1)

**Note:** AND can be found on the (-) key.

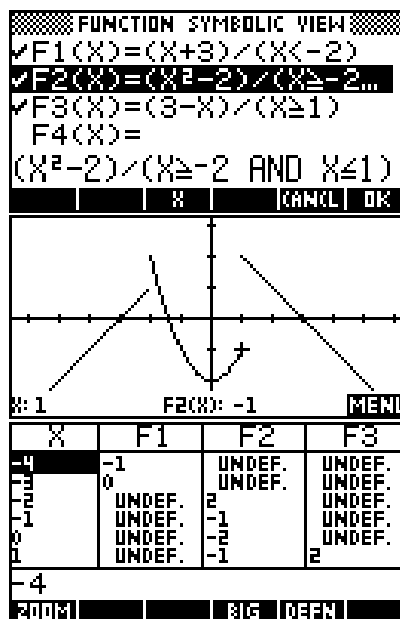

The reason why this works is that the (X < -2) and the (X ≥ -2 AND X ≤ 1) expressions are evaluated as being either true (which for computers has a value of 1) or false (which has a value of 0).

By dividing by the domain expression we are effectively dividing by 1 inside the range (no effect) or dividing by zero outside the domain, making the function undefined. Since undefined values are not graphed, this produces the desired effect.

### 'Nice' scales

As discussed earlier, the reason for the seemingly strange default scale of -6.5 to 6.5 is to ensure that each dot on the screen is exactly 0.1 apart.

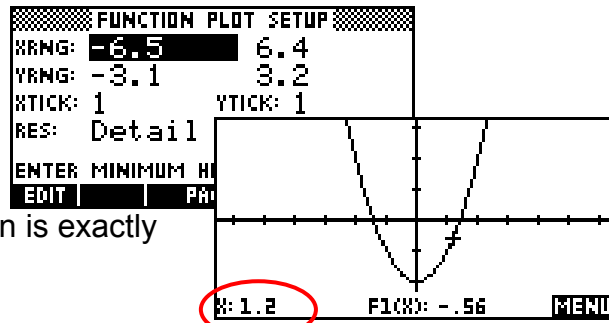

There are other scales, basically multiples of these numbers, that also give nice values if you want to **TRAC** along the graph. For example, halving each of -6.5 and 6.5 will place the dots 0.05 apart.

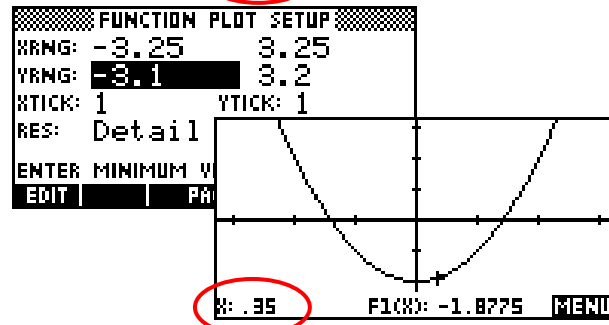

To zoom out instead of in simply double the values, producing dots that are 0.2 apart.

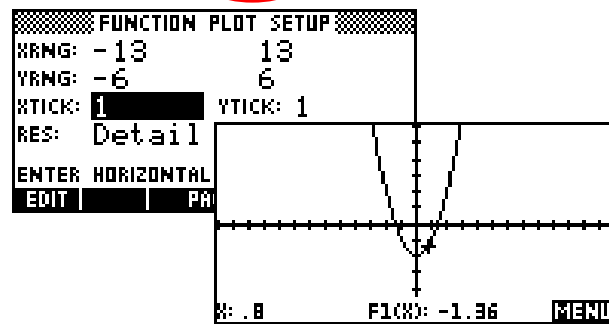

Similarly, if you want to center the graph around a particular value then just add that value to the range values. The example right is centered around  $x = 1$  by adding 1 to -3.25 and 3.25.

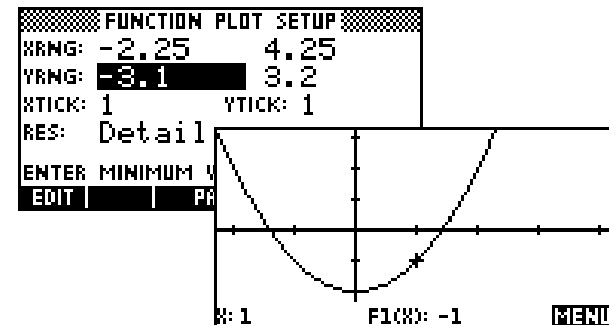

A time when 'nice' scales are more important is when you use the *Plot-Table* option in the **IEWS** menu. If you use the default axes you will find that the dots, and hence the table values are no longer 'nice' because of the 3 dots consumed by the line down the middle of the screen.

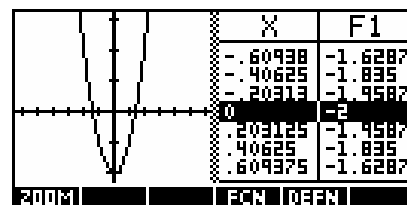

This can be solved by changing the x axis scale to -6.4 to 6.4, which gives table values of 0.2.

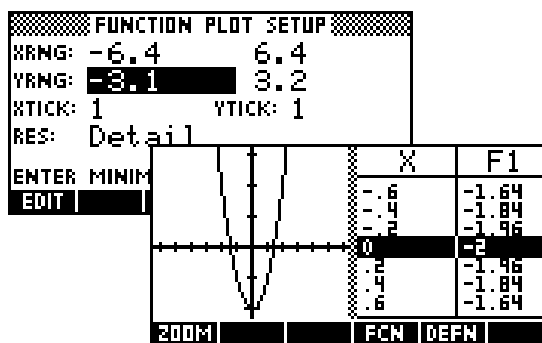

Using -3.2 to 3.2 is even better since it makes the graph 'square' again, with both axes proportional. Another good choice of scale for the Plot-Table view is -8 to 8, giving table values of 0.25. Basically any power of 2 is a good choice. Again, adding or subtracting a constant from each end of the axes will produce a graph where the y axis is not centred.

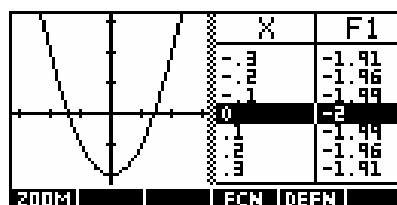

### Use of brackets in functions

One problem commonly encountered by new users is misinterpretation of brackets. The hp 39g+ will correctly interpret  $F1(X) = X^2(X+1)$  as  $X^{2*(X+1)}$  but will not understand  $F(X)=X(X+1)$ . When used in either Function or Solve, it will result in the error message of "Invalid User Function".

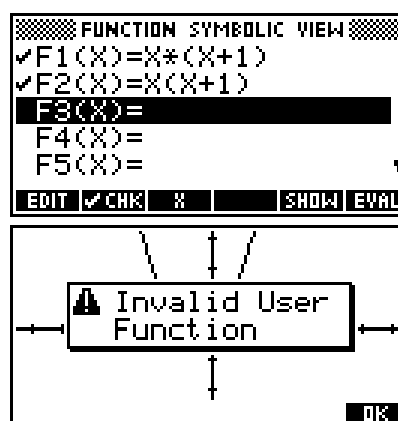

Similarly if you want to use the sum to n terms formula for a GP in the Solve applet and enter it as  $S=A(1-R^N)/(1-R)$  then you will see a similar message until you change it to read  $S=A*(1-R^N)/(1-R)$ .

The reason for this apparent 'error' is that all of the built-in functions such as SIN(...), COS(...), and ROUND(...) work with brackets. When the calculator encounters  $X(X+1)$  it interprets this as asking it to evaluate a function called  $X(...)$  at the value  $X+1$ . Since there is no such function it returns the error message that you are trying to use a function that is unknown.

The solution is simple: just remember to put the \* sign in when you use letters immediately before a bracket.

### Problems when evaluating limits

In evaluating limits to infinity using substitution, problems can be encountered if values are used which are too large.

For example: 
$$\lim_{x \rightarrow \infty} \frac{e^x}{2e^x + 6}$$

X	F1
0	.125
5	.4900933
10	.499919
15	.4999995
20	.5
25	.5

It is possible to gain a good idea of the value of this limit by entering the function  $F1(X)=e^X/(2*e^X+6)$  into the Function applet, changing to the NUM view and then trying increasingly large values. As you can see (right) the limit appears to be 0.5, which is correct.

However, if you continue to use larger values then the limit appears to change to 1 (see right). The reason for this is that the value of  $e^x$  passes the limit of the capacity of the calculator ( $10^{500}$ ), and so the top and bottom of the fraction become equal (both at a value of  $10^{500}$ ) instead of the true situation of the bottom being roughly twice the top. This is most likely to happen with limits involving power functions as they will overflow for smaller values of  $x$ .

X	F1
500	.5
1000	.5
1500	1
2000	1
2500	1

A related effect happens when investigating the behavior of the commonly

used calculus limit of  $\lim_{n \rightarrow \infty} \left(1 + \frac{1}{n}\right)^n$ .

Suppose that you wish to use the Function applet to evaluate what happens to  $F1(X)=(1+1/X)^X$  by changing to the NUM view and choosing the 'Build Your Own' facility (see right). The convergence towards  $e$  can also be seen graphically in the PLOT view but is very slow to reach high accuracy.

X	F1
100	2.704814
10000	2.718146
10000000	2.71828
1E8	2.718282
1E10	2.718282

2.71828182832



The problem lies in the fact that the slow convergence will mean that people will often try to graph this function for very large values of  $x$ . The first graph on the right shows the graph of this function for the domain of 0 to 100. The second graph shows how instability develops in the domain 0 to  $1E11$  ( $1 \times 10^{11}$ ).

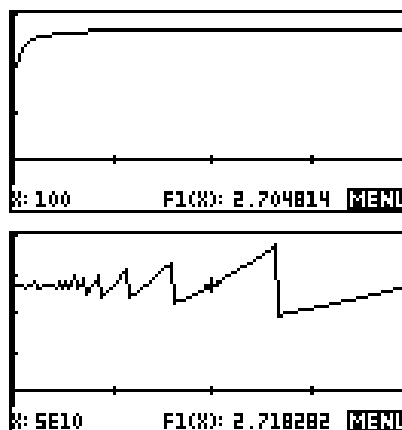

This apparent instability is caused by the internal rounding of the calculator. It works to 16 bits accuracy, which means that it can store 12 significant digits (for reasons only of interest to programmers). This means that when you invert a really large number and add it to one, you lose a lot of accuracy.

For example: if  $X = 2.85 \times 10^{10}$  then  $1/X$  is  $2.5087719298 \times 10^{-11}$ . When you add 1 to this, the calculator is forced to discard all but the last decimal place. Thus  $1 + 1/X = 1.00000000003$  (rounded off from  $1.00000000002508\dots$ )

There are naturally a whole range of numbers which will all round off to the same value of  $1.00000000003$ , so that (for that range of numbers) the expression  $(1+1/X)^X$  is equivalent mathematically (on the HP) to  $(1.00000000003)^X$ . This produces a short section of an exponential graph, which only looks linear because you don't see enough of it.

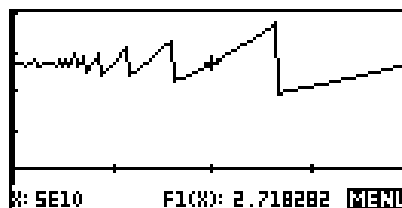

Eventually the calculator reaches a value on the  $x$  axis which is large enough that it rounds off to a smaller number than  $1.00000000003$ , which is  $1.00000000002$ . This produces the sudden drop in the graph as the plot changes from a section of a  $1.00000000003^X$  graph to a section of a  $1.00000000002^X$  graph (which has a shallower gradient).

This section is maintained until the next drop, and so on. Finally, at the value  $x = 2 \times 10^{11}$  the inverted value is so small that  $1+1/X$  becomes exactly 1 and the graph becomes horizontal. Of course this is completely the wrong value!

Although this explanation may be beyond the level of many students it is quite important that they have some understanding of these ideas if they use the calculator to evaluate limits. The solution to all problems of this type is to simply be aware of their existence and to allow for them rather than simply accepting the results shown in the NUM view.

## Gradient at a point

This can be introduced via the Function applet.

In the Function applet, enter the function being studied into F1(X).

To examine the gradient at  $x=3$ , store 3 into memory **A** in the **HOME** view as shown right.

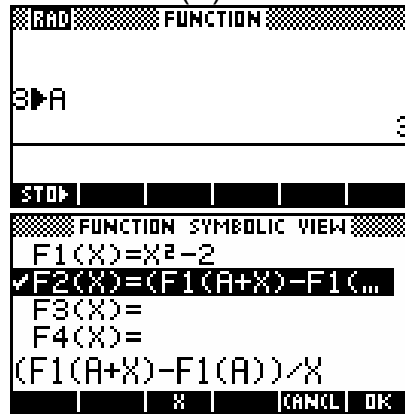

Return to the **SYMB** view, un-CHK F1(X) and enter the expression

$$F2(X)=(F1(A+X)-F1(A))/X \text{ in } F2(X).$$

This is the basic differentiation formula with  $X$  taking the role of  $h$  and  $A$  being the point of evaluation.

$$f'(a) = \lim_{h \rightarrow 0} \frac{f(a+h) - f(a)}{h}$$

Change to the **NUM SETUP** view and change the NumType to "Build Your Own". By entering successively smaller values for  $X$  you can now investigate the limit as  $h$  tends towards zero.

FUNCTION NUMERIC SETUP	
NUMSTART:	0
NUMSTEP:	.1
NUMTYPE:	Build Your Own
X	F2
.5	6.5
.1	6.1
.01	6.01
.001	6.001
.00001	6.00001
.5	

To investigate the gradient at a different point simply change back to the **HOME** view, enter a new value into **A** and then return to the **NUM** view.

The disadvantage of the previous method is that it is not very visual. An alternative is to use an applet downloaded from the web.

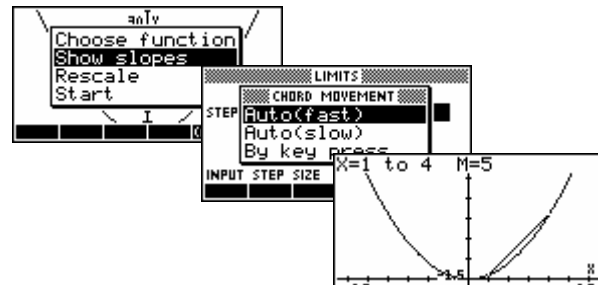

## Finding and accessing polynomial roots

The **POLYROOT** function can be used to find roots very quickly, but the results are often difficult to see in the **HOME** view, particularly if they include complex roots. This can be dealt with easily by storing the results to a matrix.

For example, suppose we want to find the roots of  $f(x) = x^3 - 3x^2 + 3$ . We will use the **POLYROOT** function and store the results into **M1**.

```

RND  FUNCTION
POLYROOT([1,-3,0,3])>M1
[-.879385241572,1.3472...
STOP
    
```

The advantage of this is that you can now view the roots by changing to the **Matrix Catalog**, and pressing **EDIT**. See page 170 for more detailed information on matrices.

```

MATRIX CATALOG  BEIM3
M1 3 REAL VECTOR  .OEM3
M2 1X1 REAL MATRIX  OK3
M3 1X1 REAL MATRIX
M4 1X1 REAL MATRIX
M5 1X1 REAL MATRIX
EDIT  NEW  SE
M1 VECTOR
1  -.879385241572
2  1.34729635533
3  2.53209
-.879385241572
EDIT  INS  GD↓  BIG
    
```

In addition to this, you can access the roots in the **HOME** view as shown.

```

RND  FUNCTION
M1(1)
    -.879385241572
M1(2)
    1.34729635533
STOP
    
```



### Calculator Tip

This trick is particularly helpful if you are working with complex roots. Not only does it make it easier to re-use them it makes it easier to tell at a glance which are real and which complex.

## THE VIEWS MENU

In addition to the views of **PLOT**, **SYMB** and **NUM** (together with their **SETUP** views), there is another key which we have so far only used very fleetingly - the **VIEWS** key.

It may seem odd to devote an entire chapter to what might appear to be an inconsequential key. In fact, however, this button is very useful to the effective use of the calculator, and crucial if you intend to use applets downloaded from the internet.

The contents of the **VIEWS** menu changes according to which applet you are currently using. The Function applet contents are covered here but the others differ in only small ways.

However, applets downloaded from the Internet will usually have a radically different **VIEWS** menus created by the person who wrote the program for the applet. See page 214 for more information on this process if you intend to program the calculator.

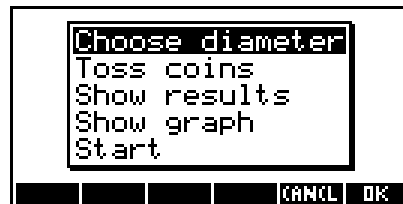

The **VIEWS** key pops up the menu on the right. We have already seen the use of the *Auto Scale* option (see page 96) and this is probably the one most used. The other options are also very useful at times.

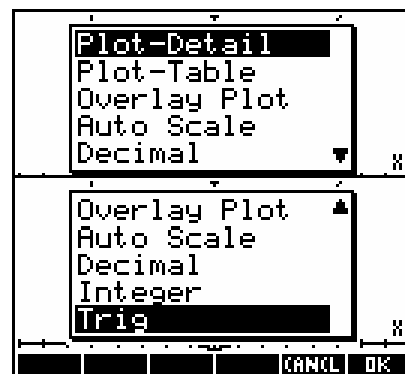

Shown on the right is the graph of  $F1(X) = X^2 - 1$ . If we press the **VIEWS** key, the menu above will pop up.

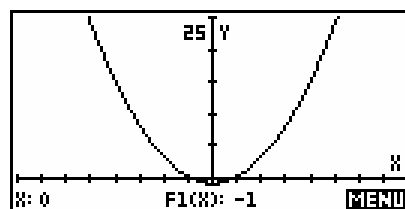

## Plot-Detail

Choosing *Plot-Detail* from the menu splits the screen into two halves and re-plots the graph in each half. The right hand side can now be used to **ZOOM** without affecting the left screen.

For example a *Box* zoom shows the result on the right allowing easy comparison of 'before' and 'after' views.

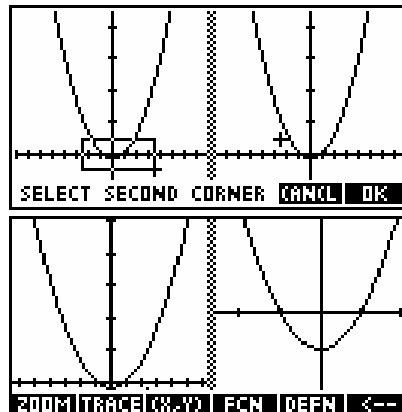

The left hand graph is always the active one, with results of actions shown on the right. We can now use the left graph again to zoom in on another section of interest, or alternatively, press the key under the **<--** label. This switches the right hand graph onto the left screen.

All the normal function tools are available except for **GOTO**.

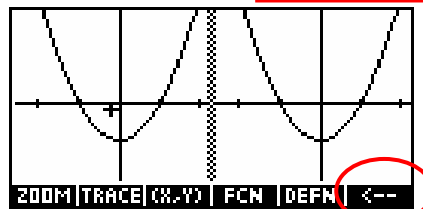

Using **TRAC** or the FCN menu you can then find or examine points of interest. Alternatively you can zoom in again using another Box zoom.

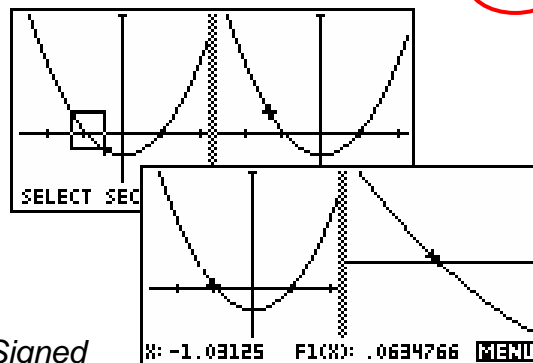

Any of the normal **FCN** tools such as *Signed Area...* or *Extremum* can be used in this split screen.

## Plot-Table

The next item on the **VIEWS** menu is *Plot-Table*. This option plots the graph on the right, with the Numeric view on the right half screen. Using the left/right arrow keys moves the cursor in both the graph and the numeric windows. See page 95 for information on how to keep nice scales in the table view. When more than one function defined in the **SYMB** view, pressing the up or down arrows changes the table focus from one to another. In this case, with only one, it centers the table.

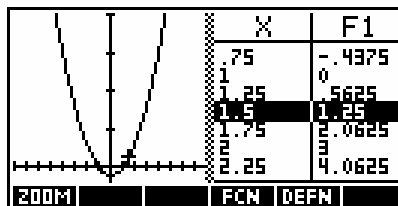

Let us switch now to a graph of the two functions  $F1(X) = X^2 - 1$  &  $F2(X) = X^3 + 2X^2 - 5X - 4$ . This shown on the right, using an XRng of -8 to 8.

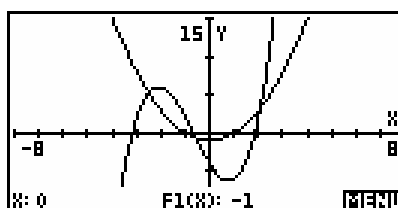

Changing to *Plot-Table* gives the result shown left. As you can see, the scale has been preserved unchanged, although without labels. The table on the right also uses a sensible scale of 0.25 because of the choice of an x axis scale of -8 to 8. Choice of scale in the Plot-Table view is discussed in detail in the “Tips and Tricks – Nice Scales” immediately following the chapter on the Function applet.

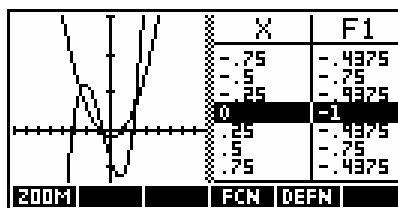

Looking at the table heading you will see that it currently shows the function F1(X). The left/right arrow keys move within that function, with the cursor keeping track. Pressing the up/down arrows now not only centers the table highlight but, more importantly switches from F1(X) to F2(X). The X column will not change.

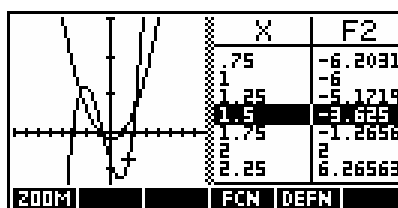

What makes this view even more useful is that the table keeps its 'nice' scale even while the usual 'FCN' tools are being used. As you can see in the screenshot left, the table is automatically repositioned to show the closest pixel value to that of the extremum found.

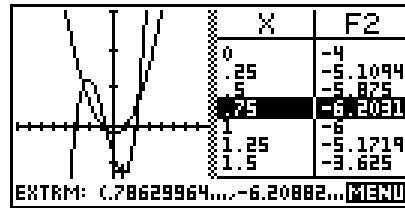

The *Signed Area...* tool is also available in this view and when the cursor is moved the values in the table follow it. Unfortunately, the highlighted value in the table doesn't change as the cursor moves to create the shaded area. For this reason the best strategy is to use the **F10** key to jump to the end point. This means that the area will not be shaded but this should not be a problem.

### Overlay Plot

Another possibility from the **VIEWS** menu is *Overlay Plot*. This option can be used to add another graph over the top of an existing one, without the screen being blanked first as it usually is. As an example, if you have already graphed functions F1(X) through to F6(X) and then add another one in the **SYMB** view, then you don't really want to have to wait while all the earlier ones are redrawn. If you un-**CHK** the earlier graphs and then use *Overlay Plot* for the new one then it will be drawn over the top of the existing ones. Of course the results will not be good if the scales don't match!

You can even use this to combine different styles of graphs. For example, the screen shot right was produced by drawing a circle in the Parametric aplet and then superimposing the equations  $y = x$  and  $y = -x$  in the Function aplet. This could be used to show, for example, enclosing curves for conic sections.

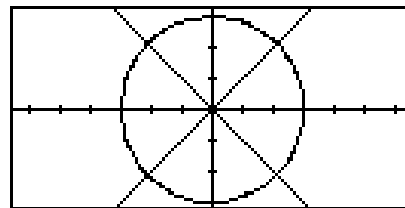

You can also use this technique to overlay functions on top of statistical graphs.

## Auto Scale

*Auto Scale* is a good way to ensure that you get a reasonable picture of the graph if you are not sure in advance of the scale. After using *Auto Scale* you can then use the **PLOT SETUP** view to adjust the results.

It is important to understand two points about how *Auto Scale* works.

1. It works by using the X-axis range that is currently chosen in **PLOT SETUP** to adjust the Y-axis range to include as much of the graph as possible. *It will not adjust the x axis.*
2. *Auto Scale* is done only for the **first** graph with a  **CHK**. If there are other graphs and they don't fit the scale then they will not benefit. As you can see in the example shown right, the quadratic shows well but the second graph (a cubic) shows only an ascending section. Zooming out would be an option at this stage, as would un- **CHK**ing the quadratic in the hopes that *Auto Scaling* the cubic might give better results (unlikely).

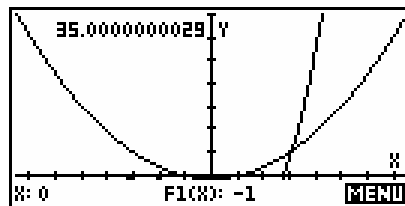

3. The resulting y scale is often not a very 'nice' one. You will usually have to adjust it in the **PLOT SETUP** view to make it look good.

The excessively thick axis in the first screen shot of the sequence of three on the right is a common result of *Auto Scale* and is caused by the value of Ytick being too small. The third graph has a Ytick value of 10 instead of 1.

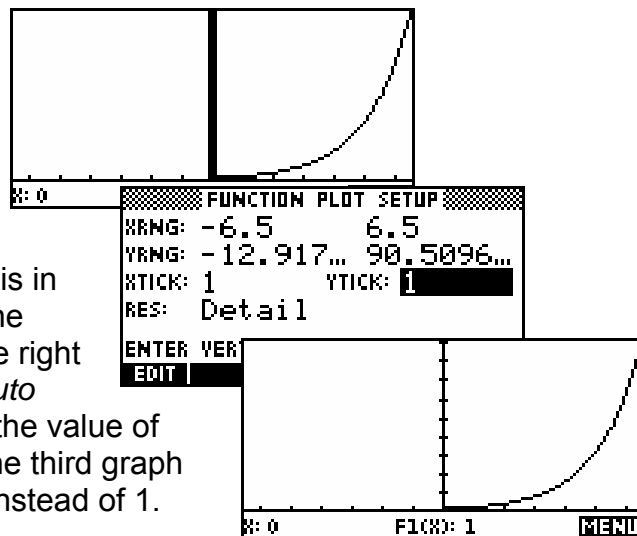



## Decimal, Integer & Trig

The next option of *Decimal* resets the scales so that each pixel (dot on the screen) is exactly 0.1. The result is an X scale of  $-6.5 \leq x \leq 6.5$  and a Y scale of  $-3.1 \leq y \leq 3.2$ . This may not give the best view of the function. Personally I don't often use it, as it is generally easier to go to the **PLOT SETUP** view and press **SHIFT CLEAR**.

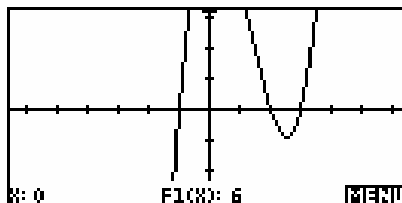

The *Integer* option is similar to decimal, except that it sets the axes so that each pixel is 1 rather than 0.1 thus giving an X scale of  $-65 \leq X \leq 65$ .

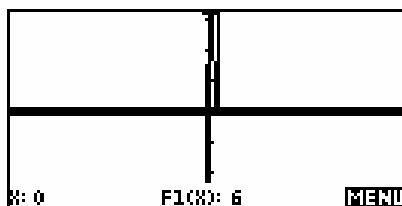

The usual result of this is rather horrible.

The final option of *Trig* is designed for graphing trig functions. It sets the scale so each pixel is  $\pi/24$ . This means that if you were graphing  $F1(X) = 2\sin(X)$  then 24 presses of the left or right arrows would move you through exactly  $\pi$  and the value would be exactly 2 instead of a horrible decimal.

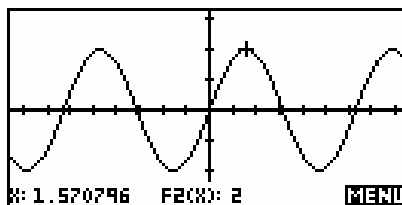

If you zoom in or out from this, the jumps will still stay relatively nice, particularly since 24 has so many factors. For example, with a zoom factor of 2, zooming out once would mean each pixel was now  $\pi/48$ , while zooming in would give a pixel jump of  $\pi/12$ .

As you can see, the cursor is nicely at a value of  $\pi/2$ , giving a y value of exactly 1 instead of only very close.

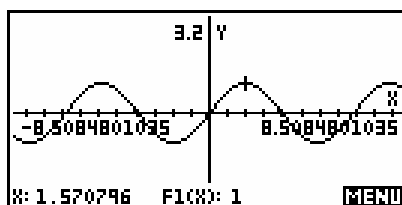

The default axes under the *Trig* option is  $-2\pi$  to  $2\pi$ . If you are primarily interested in the first  $2\pi$  of the graph then simply change Xmin to zero. Alternatively you can move the cursor to  $\pi$  (the middle) and then zoom in.

The example below uses zoom factors of 2x2 with *Recenter*:  **CHK**ed.

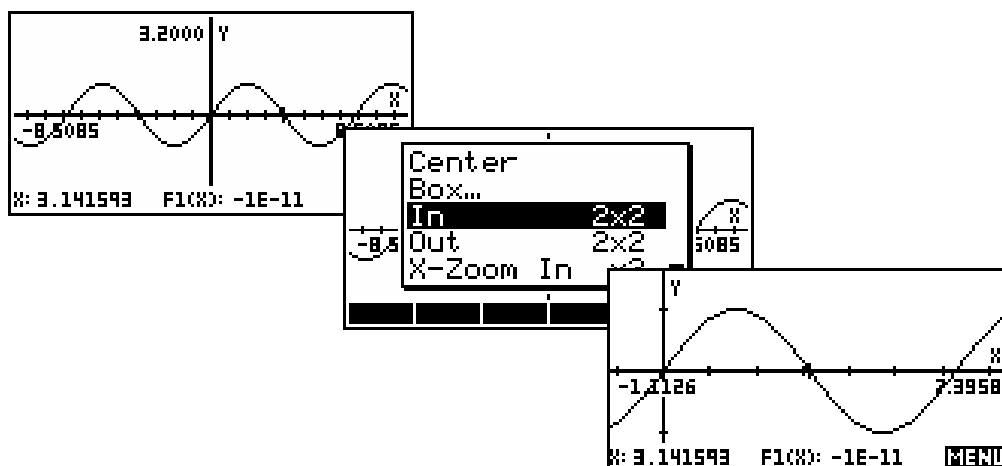

### Calculator Tip

In the graphs above the cursor is at  $x = \pi$ . The coordinates at the bottom of the screen should show  $F1(X)=0$  but doesn't due to the fact that the value of  $\pi$  stored internally is not (and of course cannot) be exact. The rounding of  $\pi$  in the 13<sup>th</sup> decimal place means that the resulting trig values will be 'wrong' in the 11<sup>th</sup> to 15<sup>th</sup> decimal place depending on the function used.

## Downloaded Aplets from the Internet

The most powerful feature of the hp 39g+ is that you can download aplets and programs from the internet to help you to learn and to do mathematics.

Two quick examples of aplets that are available are shown here. More are listed in the supplementary appendix on "Teaching Calculus using the hp 39g+". Notice that in each case the aplet is controlled by a menu. This menu is created by the programmer and 'attached' to the **VIEWS** button so that it displays in place of the normal menu.

### Curve Areas

This aplet allows the user to find approximations to the area under a curve by finding either the lower rectangular area, the upper rectangular area, or the trapezoidal area.

The user can choose the end points of the interval, the type of calculation and the number of rectangles to be used. The rectangles are drawn on the screen. A worksheet introduces the idea of integration to find areas.

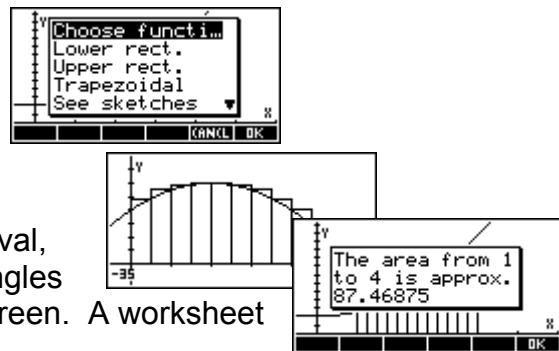

### Linear Programming

This aplet visually solves linear programming problems, finding the vertices of the feasible region and the max/min of an objective function. The final stage of finding the vertices is a bit slow on an hp 39g but more acceptable on an hp 39g+.

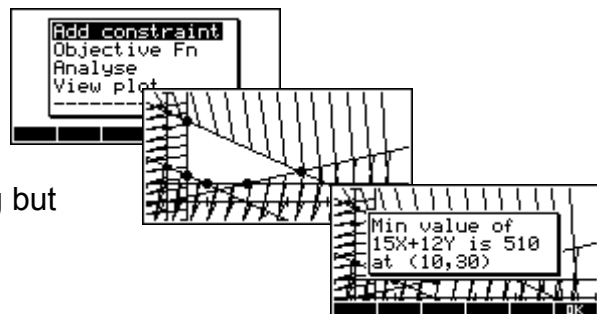

## THE PARAMETRIC APLET

This applet is used to graph functions where  $x$  and  $y$  are both functions of a third independent variable  $t$ . It is generally very similar to the Function applet and so we will look mainly at the way it differs.

An example of a graph from this applet is:

$$\left. \begin{aligned} x(t) &= 5 \cos(t) \\ y(t) &= 3 \sin(3t) \end{aligned} \right\} 0 \leq t \leq 2\pi \quad \text{which gives:}$$

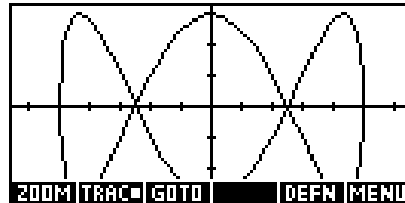

Although it you can graph equations of this type, only some of the usual **PLOT** tools are present. As you can see in the screen shot above, the **FN** key is not shown, meaning that none of its tools are available. Thinking about the nature of these equations will tell you why.

As usual the first step is to choose it in the Aplet Library. Press the **APLET** key, highlight Parametric and press **START**. If you wish to ensure that you see the same thing as the examples following then press the **RESET** button before pressing **START**.

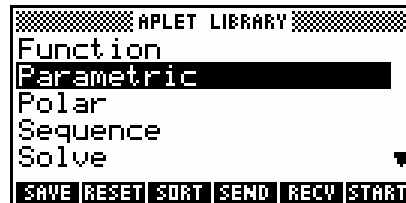

As with the Function applet, this applet begins in the **SYMB** view by allowing you to enter functions, but the functions are *paired*. Each function consists of a function in  $T$  for  $X$  and another for  $Y$ .

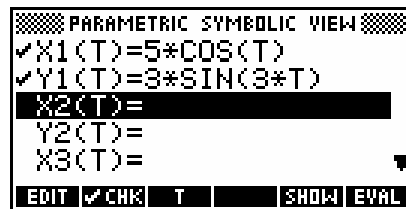

Looking at the **PLOT SETUP** view, you will see that we now have to enter a range for  $T$  as well as the usual ranges for  $X$  and  $Y$ . It is crucial to understand the different effect of the  $T$  range to that of the  $X$  and  $Y$ .

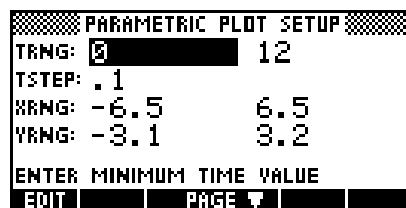

### Calculator Tip

The default setting for  $T$ Step is 0.1. In my experience this is too large and can result in graphs that are not sufficiently smooth. It is worth developing the habit of changing it to 0.05.

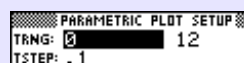

## The effect of TRng

The X and Y ranges control the lengths of the axes. They determine how much of the function, when drawn, that you will be able to see. For example...

```

PARAMETRIC PLOT SETUP
TRNG: 0 6.28318...
TSTEP: .05
XRNG: -10 10
YRNG: -6 6
ENTER MINIMUM TIME VALUE
EDIT PAGE
    
```

gives a graph of:

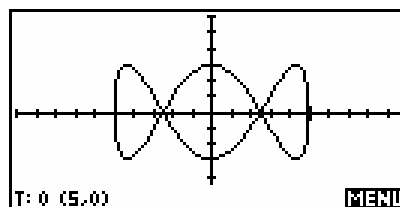

whereas..

```

PARAMETRIC PLOT SETUP
TRNG: 0 6.28318...
TSTEP: .05
XRNG: -4 4
YRNG: -2 2
ENTER MINIMUM TIME VALUE
EDIT PAGE
    
```

gives a graph of:

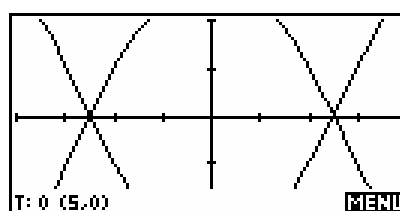

Notice that in both cases, **TRAC** is on and shows the T value, followed by an ordered pair giving (X,Y). Unlike XRng & YRng, the effect of TRng is to decide how much of the graph is drawn at all, not how much is displayed of the total picture.

For example...

```

PARAMETRIC PLOT SETUP
TRNG: 0 5
TSTEP: .05
XRNG: -5.5 5.5
YRNG: -3.5 3.5
ENTER MINIMUM TIME VALUE
EDIT PAGE
    
```

gives a graph of:

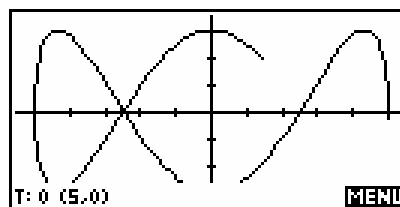

As you can see

above, changing the T range from  $0 \leq t \leq 2\pi$  to  $0 \leq t \leq 5$  gives a graph that appears only partially drawn. What constitutes "fully drawn" depends, of course, on the function used.

The value of the parameter *TStep* controls the jump between successive values of T when evaluating the function for graphing. Any graph is always a series of straight lines, and making *TStep* too large produces a graph which is not smooth. The example on the right shows *TStep* = 0.5 instead of 0.05.

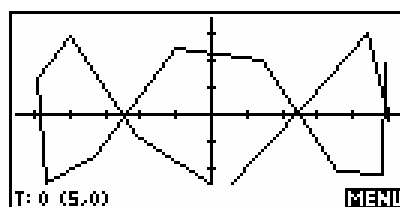



### Calculator Tip

- Decreasing  $TStep$  beyond a certain point will only slow down the graphing process but not smooth the graph further.
- Since trig functions are often used in parametric equations, one should always be careful that the angle measure chosen in **MODES** is correct. The default for all aplets is radian measure.

As usual, the **NUM** view gives a tabular view of the function. In this case there are three columns, since X1 and Y1 both derive from T.

T	X1	Y1
0	5	0
.1	4.975021	.8865606
.2	4.900333	1.693927
.3	4.776682	2.349981
.4	4.605305	2.796117
.5	4.387913	2.992485

200M | BIG | DEFN

As with the Function aplet, it is possible to change the starting point and step size of the table, and also to change it into a *Build Your Own* type of table (see page 77).

## TIPS & TRICKS - PARAMETRIC EQUATIONS

### Fun and games

Apart from the normal mathematical and engineering applications of parametric equations, some interesting graphs are available through this applet. Three quick examples are given below.

#### Example 1

Try exploring variants of the graph of:

$$x(t) = 3 \sin 3t$$

$$y(t) = 2 \sin 4t$$

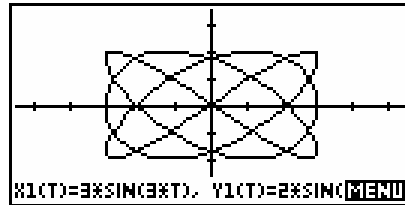

#### Example 2

Try varying the values of  $a$  and  $b$  in the equations:

$$x1(t) = (a+b)\cos(t) - b\cos\left(\left(\frac{a}{b}+1\right)t\right)$$

$$y1(t) = (a+b)\sin(t) - b\sin\left(\left(\frac{a}{b}+1\right)t\right)$$

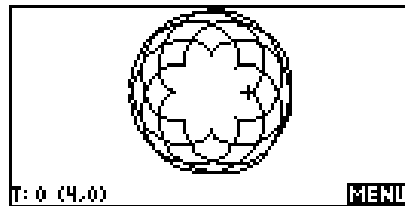

*Hint:* The example shown uses  $a=4$ ,  $b=2.5$  and has axes set with TRng of 0 to 31.5 step .2, XRng of -21.66 to 21.66 and YRng of -12 to 9. It also has Axes un **CHK**d in **PLOT SETUP**.

## Vectors

The Parametric applet can be used to visually display vector motion in one and two dimensions.

### Example 1

A particle P is moving in a straight line. Its velocity  $v$  (in  $\text{ms}^{-1}$ ) at any time  $t$  (in seconds,  $t > 0$ ) is given by  $v(t) = 2t^3 - 5t^2 + 2t - 3$ .

Illustrate its motion during the first 2.5 seconds.

Enter the motion equation from (v) as X(T) and enter Y(T)=T. The only purpose of this second equation is to move the particle up the y axis as it traces out its path, thereby making it easier to view.

```
PARAMETRIC SYMBOLIC VIEW
X1(T)=2*T^3-5*T^2+2...
Y1(T)=T
X2(T)=
Y2(T)=
X3(T)=
EDIT [CHK] T [SHOW] EVAL
```

Changing to the NUM view lets me scroll through the first three seconds of movement, allowing me to choose a good scale for the x axis.

T	X1	Y1
0.25	-4.40625	0.25
0.5	-4.5	0.5
0.75	-4.09375	0.75
1	-3	1
1.25	-1.03125	1.25
1.5	2	1.5

2.5  
ZOOM [BIG] DEFN

I'm interested in the first 2½ seconds only, so I'll also restrict TRng to 0 to 2.5. Using Y(T)=T for this TRng means the y values will also range from 0 to 2.5. Maximizing visibility of this range of values is the reason for setting YRng to be -0.5 to 3 in PLOT SETUP. The range for the x axis is chosen from the values shown in the NUM view. The value of TStep is carefully chosen so that when the motion plots, the speed is slow enough to show its progress.

```
PARAMETRIC PLOT SETUP
TRNG: 0 2.5
TSTEP: .04
XRNG: -6 4
YRNG: -.5 3
ENTER MINIMUM TIME VALUE
EDIT [PAGE] DEFN
```

The graph makes it plain that it doubles back twice in the first two seconds. The really nice part about this method though is that the motion can be *seen* on the screen. As the particle slows down near the turning points it does so on the screen. As it accelerates in the final section you can see this on the screen too. Obviously this can't be seen on this page, but I recommend you try this for yourself.

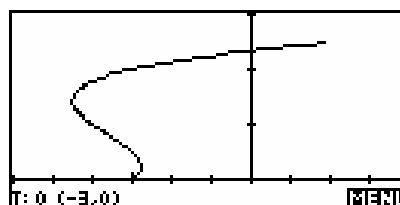



**Example 2**

Two ships are traveling according to the vector motions given below, where time is in hours and distance in kilometers. Illustrate their motion during the first ten hours.

$$\text{Ship A: } \tilde{x}_A = \begin{pmatrix} -100 \\ 500 \end{pmatrix} + \begin{pmatrix} 20 \\ -30 \end{pmatrix} t$$

$$\text{Ship B: } \tilde{x}_B = \begin{pmatrix} 200 \\ 400 \end{pmatrix} + \begin{pmatrix} -15 \\ -20 \end{pmatrix} t$$

Enter the equations of motion as shown right.

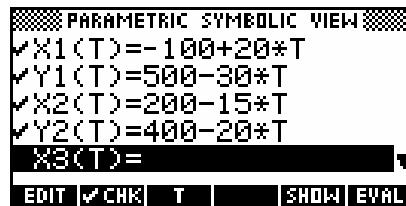

Now change to the PLOT SETUP view and set the axes to suitable values. Possible values are shown below.

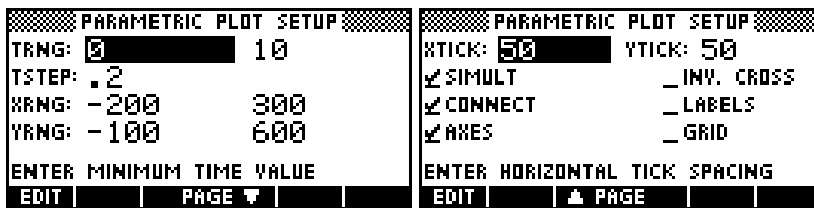

Now press PLOT to see the ships' path appear. As with the previous example, the value of TStep is chosen to allow visible motion. As the graph appears it can be seen that the ships do not collide, even though the final plot may make it appear that they do.

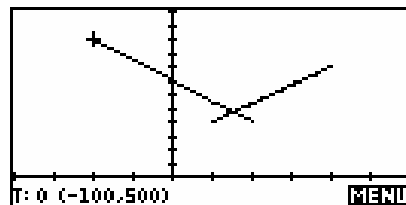

To find the distance between the two ships at any time  $t$ , you can enter the equation

$$F1(X) = \sqrt{(X1(X) - X2(X))^2 + (Y1(X) - Y2(X))^2}$$

into the Function applet. Note that the active variable must be an **X** in the Function applet instead of the **T** of the Parametric applet. Graphing this function will allow you to find its minimum value. In this case the separation is minimized at  $t=8.68$  hrs.

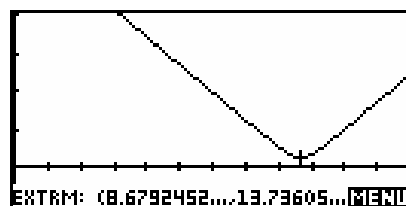

## THE POLAR APLET

This applet is used to graph functions of the type where the radius  $r$  is a function of the angle  $\theta$  (theta). As with the parametric applet, it is very similar to the Function applet and so the space devoted to it here is limited mainly to the way it differs. Some examples of functions of this type, together with their graphs are:

$$R1(\theta) = 4 \cos(3\theta)$$

$$R2(\theta) = 0.5\theta$$

$$R3(\theta) = 3 + |2 \sin(10\theta)|$$

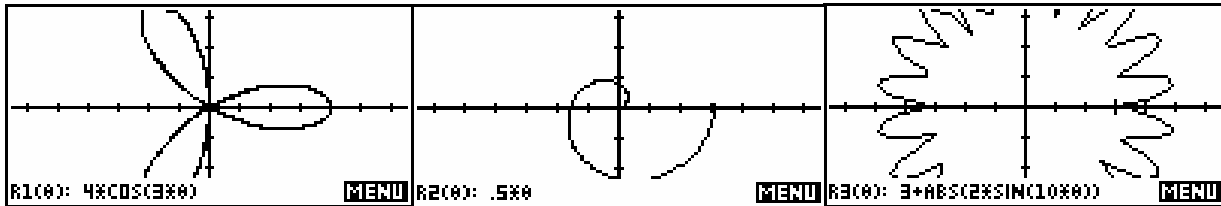

The **PLOT SETUP** view shows that ranges must be specified not only for X and Y but for  $\theta$ . The values set for XRange and YRange control the length of the axes. The movement of the cursor follows the increments set for  $\theta$  in  $\theta$ Step regardless of the resulting X and Y positions.

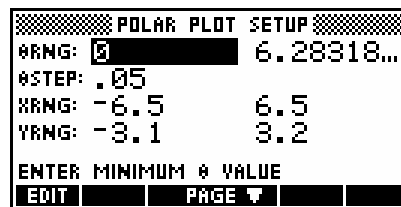

The values of  $\theta$ Range and for  $\theta$ Step are critical in controlling the appearance of the graph. The values set for  $\theta$ Range control how much of the graph is drawn, while the values for XRange and YRange only control how much of the graph is displayed on the screen once drawn.  $\theta$ Step controls how smooth the graph is, as did TStep in the Parametric applet. The default values for  $\theta$ Range are  $0 \leq \theta \leq 2\pi$  and the default value for  $\theta$ Step is  $\pi/24$ .

The default for  $\theta$ Step often results in graphs which are not very smooth and 0.05 is a better compromise between smoothness & speed. If you particularly want to use a fraction of  $\pi$  to aid in tracing the graph then try  $\pi/60$ .

If it is important to have a set of axes that are 'square', so that circles do not look oval, then use the default values. If the resulting axes don't show enough of the function, then **ZOOM** in or out. The **ZOOM Square** option can also be used to achieve round circles.

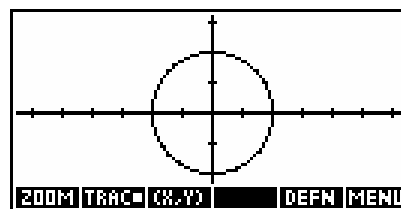

## THE SEQUENCE APLET

This applet is used to deal with sequences, and indirectly series, in both non-recursive form (where  $T_n$  is a function of  $n$ ) and implicit/recursive/iterative form (where  $T_n$  is a function of  $T_{n-1}$ ).

Examples of these types of sequences are:

(explicit/non-recursive)

$$T_n = 3n - 1 \quad \dots \quad \{2, 5, 8, 11, 14, \dots\}$$

$$T_n = n^2 \quad \dots \quad \{1, 4, 9, 16, 25, \dots\}$$

$$T_n = 2^n \quad \dots \quad \{2, 4, 8, 16, 32, \dots\}$$

(implicit/recursive)

$$T_n = 2T_{n-1} - 1 \quad ; T_1 = 2 \quad \dots \quad \{2, 3, 5, 9, 17, \dots\}$$

$$T_n = 5 - T_{n-1} \quad ; T_1 = 2 \quad \dots \quad \{2, 3, 2, 3, 2, \dots\}$$

$$T_n = T_{n-1} + T_{n-2} \quad ; T_1 = 1, T_2 = 1 \quad \dots \quad \{1, 1, 2, 3, 5, 8, \dots\}$$

As with most applets, the Sequence applet starts in the **SYMB** view when you enter formulas. The Sequence applet uses the terminology  $U(N)$  rather than the other commonly used  $T_n$  for its definitions in order to avoid having to use subscripts which would not show up well on the screen. All functions of this type are assumed to be defined for the positive integers only - for  $N = 1, 2, 3, 4, \dots$

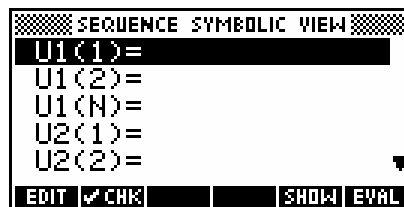

Each definition has three entries -  $U1(1)$ ,  $U1(2)$  and  $U1(N)$  (see above). If the sequence is non-recursive then only the  $U1(N)$  entry need be filled in, with the other two entries calculated automatically from the definition.

Let's start with a non-recursive sequence of  $T_n = 2^n$ . If you type it in

as shown right (using the **XT0** button to get  $N$ ), press **ENTER** and then watch carefully, you will see the entries for  $U1(1)$  and  $U1(2)$  filled in automatically.

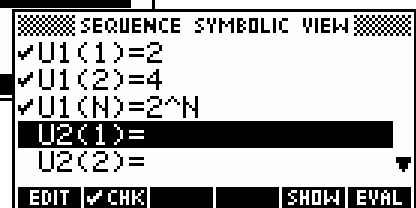
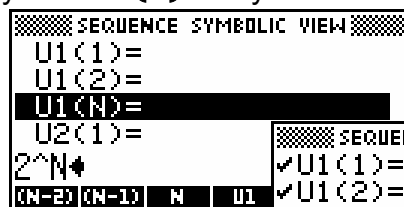

As they do, **CHK** marks appear on all three, but **CHK**ing or un-**CHK**ing any one does the same for all three.

There are a number of very convenient extra buttons provided at the bottom of the screen when entering sequences.

Two of these - **U1** and **N** - are available as soon as the cursor moves onto the U(N) line (see right). Pressing either will enter the appropriate text into the sequence definition.

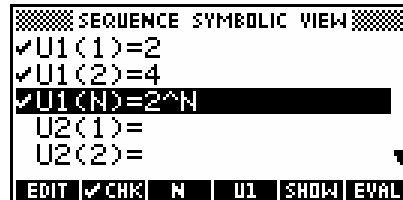

The rest become visible once you have begun to enter the sequence definition.

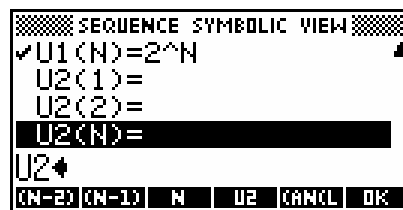

For example, suppose we enter the Fibonacci sequence into U2 by defining U2(N) as U2(N-1) + U2(N-2). Rather than having to type all of this we can use the buttons provided, pressing:

**U2** then **(N-1)** then **+** then **U2** then **(N-2)**

This is a very convenient feature, and worth remembering. The result...

There is no **CHK** mark next to the definition yet, since the sequence is defined recursively and no values have yet been given for U2(1) and U2(2). Type in a value of 1 for both of these and then press the **NUM** button to switch to the **NUM** view.

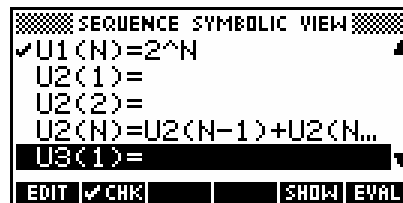

As you can see in the screenshot right, the **NUM** view shows the actual values in the sequence as a table. If you move the highlight into the U1 and U2 columns, you can press the **DEFN** button and see the sequence rule. You can experiment for yourself and see the result of pressing the **BIG** button (see next page for an example). The **ZOOM** button is also available as usual, but it is easier to use other methods.

	N	U1	U2
1	1	2	1
2	2	4	1
3	3	8	2
4	4	16	3
5	5	32	5
6	6	64	8

1

**ZOOM** **BIG** **DEFN**

The **NUM SETUP** view offers more useful features. Change to that view now and change the *NumStep* value to 10. If you then swap back to the **NUM** view you will see (as right) that the sequence jumps in steps of 10. In case you don't realize...  $2.1475 \times 10^9$  is 'computer speak' for  $2.1475 \times 10^9$ .

N	U1	U2
1	2	1
11	2048	89
21	2097152	10946
31	2.1475E9	1346269
41	2.149E12	1.6558E8
51	2.252E15	2.037E10

1  
ZOOM      BIG   DEFN

Now go back to the **NUM SETUP** view and change the *Automatic* setting to *Build Your Own* by moving the highlight to it and pressing the **+** key or by using **CHOOSE**. Switch back to the **NUM** view and enter the values **1**, **10**, **50** and **100** into the N column.

N	U1	U2
1	2	1
10	1024	55
50	1.13E15	1.26E10
100	1.27E30	3.54E20

12586269025  
EDIT   INS   SORT   BIG   DEFN

You will find that the values for those terms of each sequence will appear in the U1 and U2 columns almost immediately. In case you didn't realize, the reason for the larger text is that I have used the **BIG** button.

Due to the type of problems one is usually trying to solve with sequences, the **NUM** view rather than the **PLOT** view is often more useful in this applet, but let's have a look at the **PLOT** view anyway. Two types of plots are available, the default being *Stairstep*.

SEQUENCE PLOT SETUP	
SEQPLOT:	Stairstep
NRNG: 1	24
XRNG: -2	24
YRNG: -5	25
CHOOSE SEQUENCE PLOT TYPE	
CHOOSE	PAGE

SEQUENCE PLOT SETUP	
XTICK: 1	YTick: 5
<input checked="" type="checkbox"/> SIMULT	<input type="checkbox"/> INV. CROSS
<input checked="" type="checkbox"/> AXES	<input checked="" type="checkbox"/> LABELS
<input type="checkbox"/> GRID	
PLOT FUNCTIONS SIMULTANEOUSLY?	
<input checked="" type="checkbox"/> CHK	PAGE

Change to the **PLOT SETUP** view and ensure that the setup view is the same as that shown in the two screens above right. Then change to the **PLOT** view and you should see a graph similar to the one shown below right. The second type of graph is the *Cobweb*.

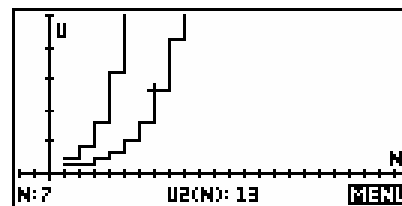

## TIPS & TRICKS - SEQUENCES & SERIES

### Defining a generalized GP and the sum to n terms.

If we define our GP using memory variables then it becomes far more flexible.

RPN SEQUENCE	
5 → A	5
.75 → R	.75
<span style="float: left;">STO</span>	

The advantage of this method is that you now need only change the values of A and R in the HOME view to change the sequence.

N	U1		
1	5		
2	3.75		
3	2.8125		
4	2.109375		
5	1.582031		
6	1.186523		
1			
ZOOM       BIG   DEFW			

Defining a series (sum to n terms of a sequence) is fairly straightforward using a similar method.

SEQUENCE SYMBOLIC VIEW		N	U1	U2	
✓ U1(N)=U1(N-1)*R		1	5	5	
✓ U2(1)=A		2	3.75	8.75	
✓ U2(2)=A+A*R		3	2.8125	11.5625	
✓ U2(N)=U2(N-1)+U1(N)		4	2.109375	13.67188	
U3(1)=		5	1.582031	15.25391	
		6	1.186523	16.44043	
1					
ZOOM       BIG   DEFW					

Note the reference to U1 in the definition of U2.

Once U2 is defined in this way you can change both U1 & U2. by simply storing new values into A and R.

### Solving sequence problems

Questions like “What term is the first to be greater than 10 000?” or “When does  $S_n$  first exceed 10 000?” can be answered in the NUM view.

Simply move into the N column, make an inspired guess as to the term you require and type it in. The table jumps to that value.

N	U1	U2	U3
1	5	5	5
2	3.75	8.75	15
3	2.8125	11.5625	26
4	2.109375	13.67188	42
5	1.582031	15.25391	65
6	1.186523	16.44043	100
35			
CANCEL   OK			

For example, in answer to the first question, we estimate  $N=35$ . However we find that  $U1(35)$  is far too large. By successive guesses, we find that  $T_{15}$  is the one we were seeking. The second problem is as easily solved in this way.

N	U1	U2	U3
34	8.5899E9	1.718E10	1.718E10
35	1.718E10	3.436E10	3.436E10
36	3.436E10	6.872E10	6.872E10
37	6.872E10	1.374E11	1.374E11
38	1.374E11	2.749E11	2.749E11
39	2.749E11	5.498E11	5.498E11
35			
ZOOM       BIG   DEFW			

Population type problems are also easily dealt with in this way.

For example, “A population of mice numbers 5600 and is growing at a rate of 12.5% per month. How long will it be until it numbers more than one million?”

Pressing **CLEAR** (above **DEL**) clears out the existing expressions, and I can enter my formula. The two values of 5600 and 6300 are automatically calculated. All we need do now is switch to the Numeric view to find, with some experimenting, that  $U_1(46)$  is the first to exceed one million.

N	U1
41	622714.4
42	700553.7
43	788132.9
44	886638.9
45	997468.1
46	1122152

It is also possible to answer these questions in the Solve aplet. For example if we use the Sequence aplet to define  $U_1(N)=2^{(N-1)}$  as before, then we can change to the Solve aplet and enter into E1 the equation  $U_1(N)=10000$ , change to the **NUM** view and press **SOLVE** and obtain an answer of 14.29 . This means, of course that  $N=15$  is the first term exceeding 10000.

The reason why we did not use  $E_1(N) > 10000$  is that the Solve aplet is unable to deal with inequalities even though no error message is given if you try.

### Modeling loans

I need to see the progress of a loan of \$10,000 at a compound interest of 5.5% p.a., starting Jan. 1 1995, with a quarterly repayment rate of \$175. Set up U1 and U2 as shown above.

You can now follow the progress of the loan, with U1 containing time and U2 the amount owing at the start of each time period, showing it is repaid during the first quarter of 2023.

```

SEQUENCE SYMBOLIC VIEW
✓U1(1)=1995
✓U1(2)=1995.25
✓U1(N)=U1(N-1)+.25
U2(1)=
U2(2)=

```

```

SEQUENCE SYMBOLIC VIEW
✓U2(1)=10000
✓U2(2)=10000*1.0137-175
✓U2(N)=U2(N-1)*1.0137-175
U3(1)=
U3(2)=

```

	N	U1	U2
1	1995	10000	
	1995.25	9962.5	
	1995.5	9924.484	
	1995.75	9885.946	
	1996	9846.878	
	1996.25	9807.272	
1			
ZOOM     BIG   DEFN			
	N	U1	U2
110	2022.25	643.763	
111	2022.5	477.6147	
112	2022.75	309.1819	
113	2023	138.4332	
114	2023.25	-34.6634	
115	2023.5	-210.14	
110			
ZOOM     BIG   DEFN			



## THE SOLVE APLET

This applet will probably rival the Function applet as your 'most used' tool. It solves equations, finds zeros of expressions involving multiple variables, and even involving derivatives and integrals.

To ensure that we are using the same terminology, let's define our terms first.

An equation includes an = sign, and can usually be solved:

eg. 
$$\left. \begin{array}{l} y = x^2 \\ v^2 = u^2 - 2ad \\ \frac{b}{c} + 1 = \frac{a+3}{d} \\ x^2 - 6x + 5 = 0 \end{array} \right\} \dots \text{are all equations.}$$

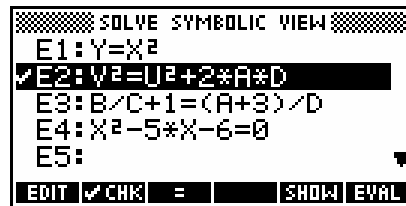

Note the = sign provided for convenience.

An expression, on the other hand, does not contain an = sign. It can be evaluated or rearranged but not solved. When you enter an expression into the Solve applet it internally puts an "= 0" onto the end so as to convert it into an equation which can be solved.

eg. 
$$\left. \begin{array}{l} x^2 - 4 \\ \frac{b-1}{c} + 1 \\ x^2 - 6x + 5 \end{array} \right\} \dots \text{are all expressions.}$$

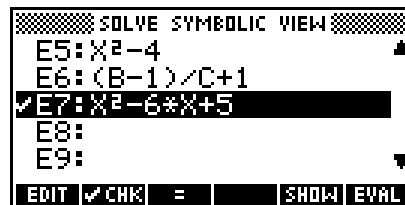

Let's start by looking at the equation  $v^2 = u^2 - 2ad$ . This equation gives the final velocity (v) of a object as a function of the initial velocity (u), the acceleration acting on it (a) and the distance traveled (d).

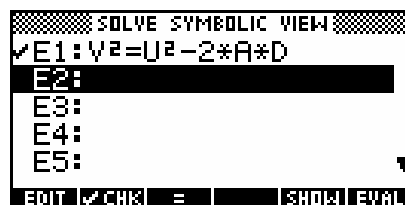

Suppose you had the problem:

“What acceleration is needed to increase the speed of a car from 16.67 m/s (60kph or ~38mph) to 27.78 m/s (100kph or 60mph) in a distance of 100m (~110 yd)?”

We'll assume that you have already entered the equation into E2 (as above) and have made sure that it is **CHK**ed.

If you press **NUM** to change to the **NUM** view, you will see something similar to the screen on the right. What values are showing on your screen will depend on what happens to be in the memories **V**, **U**, **A** and **D** at the time. Pressing **SHIFT CLEAR** will zero all values.

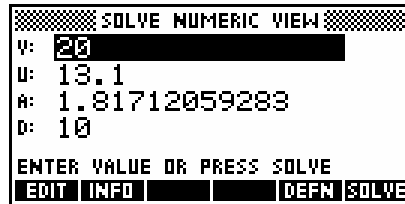

Move the highlight to **V** and enter the value 27.78 , then to **U** and enter 16.67 and finally to **D** and enter 100.

Now move the highlight back to **A** (the value you're trying to find) and press the **SOLVE** button. You should find that you obtain the answer to our problem of 2.47 m/s<sup>2</sup>.

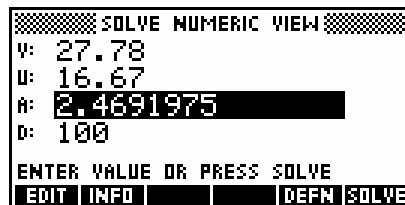

When the **SOLVE** process has finished, you can obtain a report on it by pressing the **INFO** button. The result in this case may not seem very informative but there is more about these messages on page114.

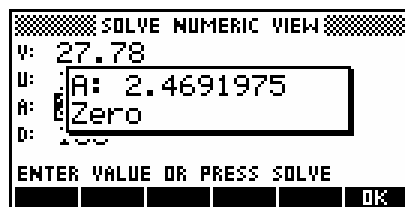

Our first example was fairly simple because there was only one solution so it did not much matter where we began looking for it. When there is more than one possible answer you are required to supply an initial estimate or guess. The Solve applet will then try to find a solution which is 'near' to the estimate.

### Example 1

The volume of a cylinder is given by  $V = 2\pi r(r+h)$ . Find the radius of a cylinder which has a volume of 1 liter and a height of 10cm.

Enter the equation into **E1** as shown right. When you are entering the equation, ensure that you put a \* sign between the **R** and the bracket. See page 87 for more information on this.

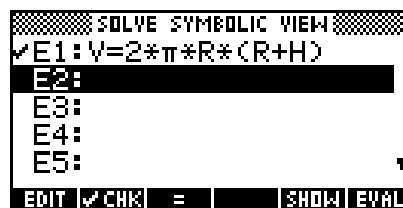

Change to the **NUM** view and enter the known values, remembering that 1 liter=1000cm<sup>3</sup>. Position the highlight over **R**, enter a positive value as your estimate, and press **SOLVE** to find the solution shown right of 8.57cm. The equation is a quadratic in **R** which means two solutions are possible. If you enter an initial estimate of -10 you will obtain the negative solution, which is physically invalid in this case.

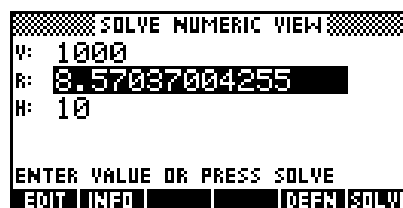

### Example 2

If  $f(x) = x^3 - 2x^2 - 5x + 2$  find all values of  $x$  for which  $f(x) = 1$ .

Although you may have a clear picture in your mind and can provide Solve with the estimates it needs, I'll assume that you would find it helpful to see a graph first.

It is also possible to solve this in the Function applet, which offers more powerful tools. The **PLOT** view in the Solve applet, although powerful, can be deceptive if you don't understand it and I sometimes find it easier to work in the Function applet. In this case we will continue to work in Solve.

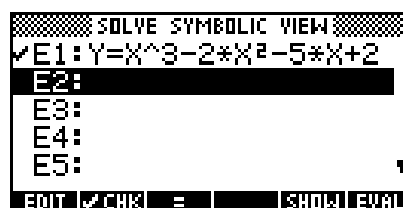

In the **SYMB** view, enter the equation  $Y=X^3-2X^2-5X+2$  into **E1**.

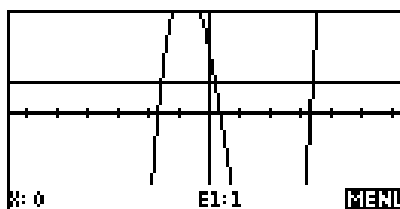

In the **NUM** view, enter the known value of  $Y=1$ , ensure that the highlight is on **X**, making it the **active** variable, and then press **PLOT**.

The **PLOT** view shows two curves. The horizontal line is the left side of the equation which, when the known value of  $Y=1$  is substituted, forms a constant straight line. The other curve is the right hand side of the equation which, since **X** is the active variable, forms a cubic. In this case the scale chosen is appropriate but this will not always be the case and some adjustment might be required in the **PLOT SETUP** view.

We require values where the two curves intersect. Using the arrow keys, move the cursor near to the first intersection point. I found (see right) that -1.6 seemed to be a good approximation. Now change back to the **NUM** view and you will find that this approximation has been carried back as the initial estimate. Press **SOLVE** to find the true value.

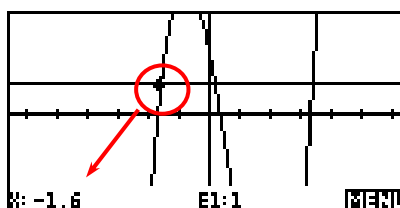

Repeat the process of obtaining an estimate in the **PLOT** view and refining it in the **NUM** view to find the other two solutions. See page 118 for information on the effect of the active variable on what you see in the **PLOT** view.

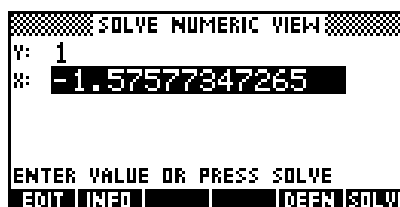

### Calculator Tip

The Solve applet is not able to cope with inequalities. Although there is no error message when you use  $<$  or  $>$ , the answer it supplies is not what you would expect. What is worse is that they are reported in **INFO** as correct!

The Solve applet can be used in conjunction with any of the functions available through the **MATH** menu, and can also reference any equations or functions defined in other applets.

### Example 3

“Find  $a$  so that  $\int_2^a x^3 - x \, dx = 4$ ”

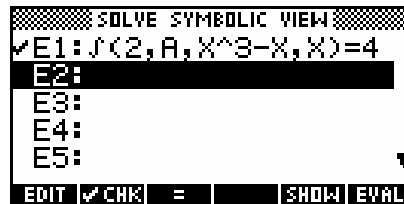

Set E1 to:  $\int(2, A, X^3 - X, X) = 4$

In the **NUM** view, set  $A$  to an initial guess of 3, and position the highlight on  $A$ . Ignore  $X$  since it is not really involved except as a temporary variable during the integration. Press **SOLVE** to obtain an answer (eventually) of 2.4495. The delay is caused by the repeated integrations as the calculator searches for better solutions.

### Example 4

“Let  $X$  be a random variable, representing the heights of basketball players. If  $X$  is normally distributed, with  $\mu = 184.5$  and  $\sigma^2 = 105$  then find the height which cuts off the tallest 5% of players.”

The **MATH** function for the normal distribution is **UTPN** (see page 282) which gives the upper-tailed probability.

In the Solve applet, set **E1** to **UTPN(184.5, 105, X)=0.05**

Enter the **NUM** view, make an estimate, and press **SOLVE** to obtain 201.35cm

#### **Further reading**

There are many more ways in which the Solve applet can be used in conjunction with the functions available in the **MATH** menu. The **MATH** menu is discussed in detail starting at page 243, with worked examples which often use the Solve applet.

### A detailed explanation of PLOT in Solve

The **PLOT** view in the Solve applet is a little more complex than most others, since the active variable ( $x$ ,  $t$ ,  $\theta$  etc) changes according to the value for which you are trying to solve.

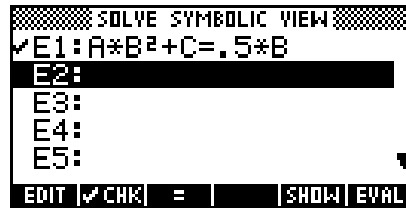

As an example, we will enter the equation  $A*B^2 + C = .5*B$  into **E1**. Suppose that we know the values of **A** and **C** but need to find **B**.

Now change to the **NUM** view and enter the values shown right. Ensure that the highlight is on **B** as shown and then press **PLOT**.

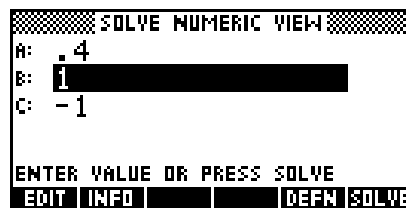

The result is a quadratic intersecting a line and the reason for this lies in how Solve interprets your equation.

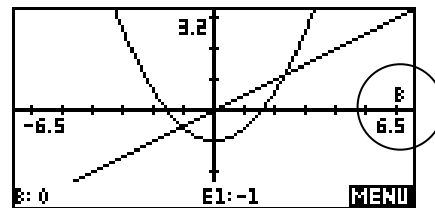

When you select **B** by highlighting it, the calculator substitutes the supplied values into all other variables except **B** and graphs the left and right sides of the equation as two separate graphs. This may not always be obvious because the substitution may produce graphs which aren't visible on the default scale.

In the graph above you can see from the label on the horizontal axis that the active variable is **B**. In this case substitution means that  $A*B^2 + C = .5*B$  becomes  $0.4B^2 - 1 = 0.5*B$ . The left side is quadratic, while the right is linear.

In this case there are clearly two points where the graphs intersect and hence where the left and right sides are equal.

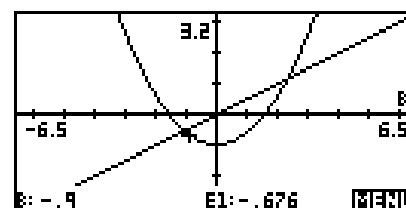

Move the cursor near to the left hand intersection and then change back to the **NUM** view. When you do so, the approximate value you chose with the cursor is transferred as your first 'guess'.

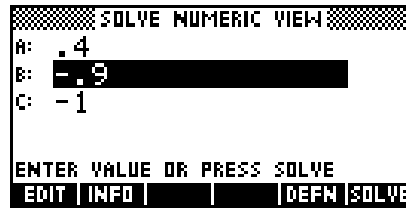

Now press **SOLVE** and you will see the hp 39g+ find the nearest solution to your guess. Finish by pressing **INFO** to verify that the solution is valid. See page 114 regarding this.

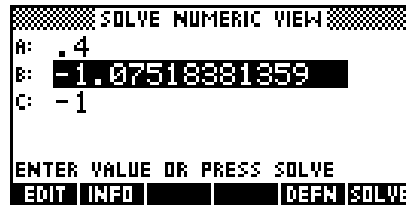

Obviously the next step is to change back to the **PLOT** view, move the cursor near to the second intersection and **SOLVE** for that one too.

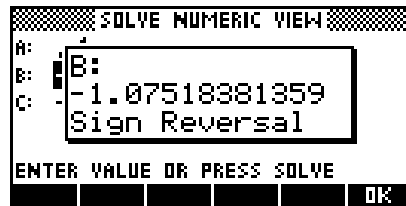

If we now change the active variable then there is an immediate change in the **PLOT** view to reflect this.

Change back to the **NUM** view and restore the variables to the original values, this time leaving the highlight on **C**.

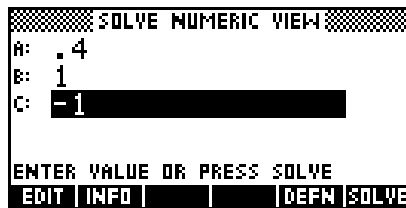

Since the active variable is now **C**, substitution of all other values means that  $A * B^2 + C = .5 * B$  becomes  $0.4 + C = 0.5$ . In this case both sides are linear and this is shown in the **PLOT** view. Notice that the axis label is now **C**. This would have only one solution and there would be no need to supply any particular starting value.

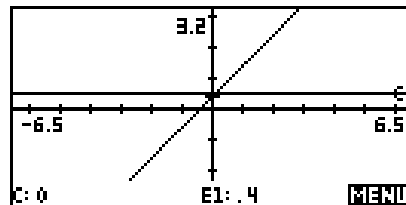

If we duplicate this process for **A** then substitution of values means that  $A * B^2 + C = .5 * B$  becomes  $A - 1 = 0.5$ . Both sides are still linear, although not the same as before, and this is shown in the **PLOT** view. Notice that the axis label is now **A**.

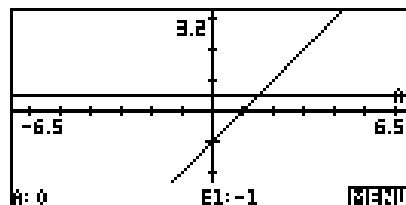

### The meaning of **INFO** messages

On pages 115, the values used were  $V=27.78$ ,  $U=16.67$  and  $D=100$  and we were solving for  $A$ .

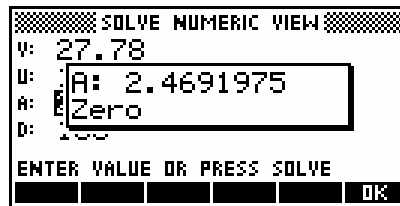

Thus:  $v^2 = u^2 - 2ad$

became:  $(27.78)^2 - (16.67)^2 + 2 \times a \times 100 = 0$  when substituted.

'**Zero**' - The calculator tried to find a value of  $A$  which made this zero and, in the **INFO** message shown above, it is reporting that it succeeded.

'**Sign reversal**' - also indicates a correct solution, since normally one expects to find an answer of zero at the point where the equation changes from positive to negative (or vice versa). 'Sign reversal' is a report that it couldn't get an answer to 12 significant digits that was precisely zero, just two answers minutely on either side of zero. This might indicate a discontinuity at the point, such as that of a reciprocal graph at  $x = 0$ , but is more likely to indicate a satisfactory answer.

The only time that you need to worry is when you receive any of the error messages. These are:

'**Extremum**' - it found a minimum, but could not reach zero. Try solving the equation  $(x-2)^2 + 4 = 0$  and you will see this. The smallest value that  $(x-2)^2 + 4 = 0$  can have is 4 at  $x = 2$ , so the answer supplied will be very close to this (such as 2.000000001 or 1.999999999). The problem is that unless you check **INFO** you may not realize that this is not actually a valid solution.



#### Calculator Tip

It is critical that students recognize this case since it occurs quite often when the two sides of the equation (left and right) come close but do not match. The student must recognize that the answer is invalid and, preferably, why.

***This is a major reason why it is often better to work in the Function applet, since it allows you to see clearly whether or not there is a solution.***

'**Bad Guess**' - the initial estimate you supplied was outside the domain of the function. For example, the equation uses a square root or a logarithm and you began from a value involving a negative.

'**Constant?**' - no solution was found. The value of the function was the same at every point tested (and wasn't the value you wanted).



## TIPS & TRICKS - SOLVE

### Easy problems

Have you ever thought “There has to be an easier way!” when confronted in a test with something like:

$$\frac{(x-1)}{3} - 1 = \frac{2}{9} - \frac{(3-x)}{4}$$

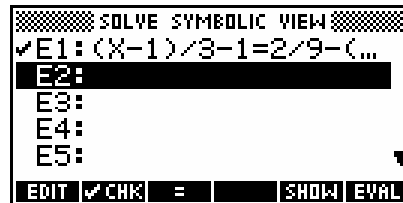

If you're sure there is only one answer to a problem, as there is in this case, then solving it is simply a matter of entering the equation into the **SYMB** view and solving it.

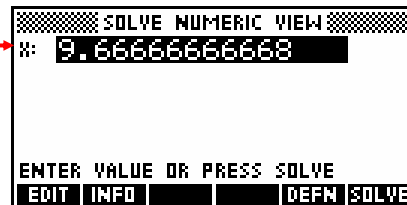
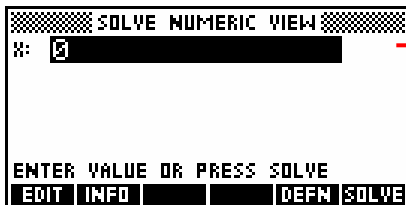

### Harder problems

When you know or suspect that there is going to be more than one solution to a problem then the **PLOT** view can help you to obtain estimates.

For example:  $\frac{2}{x} = \frac{(x+1)}{2}$

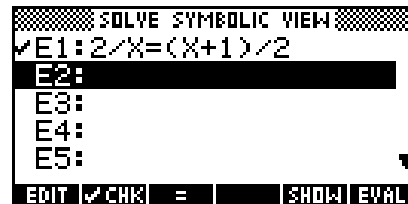

When you plot this you can see that the solutions are near -2 and 1.5. If we now switch to the **NUM** view we can use these as initial guesses. This will give solutions of -2.56 and 1.56.

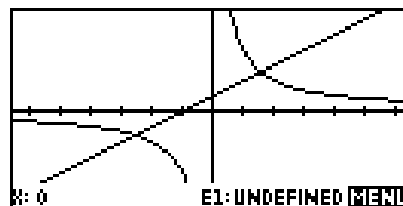

In this case the problem shown will graph easily on the default **PLOT** view but this will not always be the case. You may need to adjust the axes in **PLOT SETUP**. Your teacher may insist on an answer given as a surd, or on showing all working, but even in that case you'll at least be able to check your answer.

## THE STATS APLET - UNIVARIATE DATA

One of the major strengths of the hp 39g+ is the tools it provides for dealing with statistical data. The Statistics applet and its companion the Inference applet provide very powerful yet easy to use tools with which to analyze statistical data.

Unlike most others, the Statistics applet begins in the **NUM** view, offering easy input and editing of values, while the **SYMB** view is reserved for specifying which columns contain data and which ones frequencies, as well as for indicating pairing of columns for bivariate data. If you have not already done so, go to the **APLET** view, **RESET** and then **START** the Statistics applet.

The hp 39g+ treats univariate and bivariate data quite differently and those differences are reflected in the **SYMB** and **PLOT** views.

Because of this the Statistics chapter has been split into two and univariate data will be dealt with first. On the screen you will see a key labeled either **UNVAR** or **BIVAR**. Pressing the key under this label changes from univariate (**UNVAR**) to bivariate (**BIVAR**) and back. Make sure the key is showing **UNVAR** before proceeding.

n	C1	C2	C3	C4
1				

EDIT INS SORT BIG UNVAR STATS

If your **NUM** view had some data in it, you could press **CLEAR** (above **DEL**) and choose *All columns*. The **DEL** key is used to delete individual data points, rather than whole columns.

n	C1	C2	C3	C4
1				

CLEAR...  
C1  
All columns

CANCEL OK

Let's use the following set of data and obtain all the usual statistics on it, and also plot a histogram and a box & whisker graph.

{ 2, 3, 1, 0, -2, 3, 4, 2, 2, 0, 6, 2, 3, 1, 0, 4, 1, 3, 3, 2 }

Move the highlight into column C1 and enter the data, pressing the **ENTER** key after each piece of data.

n	C1	C2	C3	C4
15	4			
17	1			
18	3			
19	3			
20	2			
21				

EDIT INS SORT BIG UNVAR STATS

Looking at the bottom of the screen you will see a series of tools provided for you. **EDIT** is not really worth bothering with. It is generally easier just to retype a number than it is to press **EDIT** and then use the arrow keys and **DEL** to change it.

The key labeled **INS** inserts space for a new number by shifting all the numbers down one space. **SORT** does exactly what it says... it sorts the data into ascending or descending order. The extra fields in the screen shot right are used with bivariate sorts or frequency tables and will be explained in that section of the notes. Press **CANCL** to stop the sort.

SORT SETUP	
SORT ORDER:	Ascending
INDEPENDENT:	C1
DEPENDENT:	None
CHOOSE SORT ORDER	
<b>CHOOSE</b>	<b>CANCL</b> <b>OK</b>

The **BIG** key behaves normally and **LVAR** vs. **RVAR** we have already discussed. The last key labeled **STATS** is the really useful one.

Making sure the highlight is in column C1, press the **STATS** key and you will see the screen shown right. If you use the down arrow, you can scroll down and see the rest of the screen (below right).

1-VAR	H1		
N	20		
TOT	40		
MEAN	2.0000		
STDEV	1.57895		
SEDEV	1.732051		
20			
			<b>OK</b>

**NOTE:** If you get an error message instead of summary statistics, you may have forgotten to **RESET** the aplet.

1-VAR	H1		
SEDEV	1.777047		
MIN	1.2		
Q1	1.5		
MEDIAN	2.0		
Q3	2.5		
MAX	3.0		
6			
			<b>OK</b>

As you can see in the screens above right, the hp 39g+ gives not only the standard statistics that any scientific calculator would give, but also the minimum and maximum values, the median and the upper and lower quartile cutoffs. The mode is not given, but this is easily obtained from the histogram as we will see later.

Let's create a second column of data, and cheat by making all its values double the values in the first column. We can use the **HOME** view to avoid having to retype the values as follows...

- \* Change to the **HOME** view and type the command shown right, then press **ENTER**.



- \* Press the **NUM** key to change back to the **NUM** view. You should find your new column created and ready.

If you now use the **STATS** key, you will find that you still only see statistics for the first column (H1). The reason for this is that you have not set up the second column in the **SYMB** view. The default setup is to only recognize column 1.

Change into the **SYMB** view and edit yours so that it looks like the one on the right. You must make sure that H2 is **CHK**ed, because only checked columns will show in the **STATS** view.

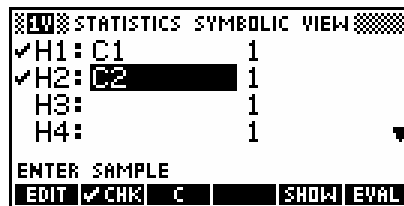

Note that a screen key is provided to give you the letter **C** without having to use the **ALPHA** key.

The stats are now available for both columns of data.

As an alternative to the method used above, you could also have created a 'virtual' column of data by using the **SYMB** view. Simply enter an expression giving the new column as a function of the old one. Although the 'virtual' column will not be displayed in the **NUM** view, it can now be graphed and analyzed normally.

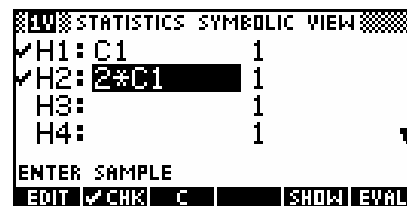

You may be wondering why the **SYMB** view is organized around histograms H1, H2 . . . H9 rather than simply around the columns C1, C2 . . . C9. The reason is that it allows you to easily cope with a frequency table by setting up one column to represent values and another to represent the frequencies. If not using a frequency table, the frequencies are normally set, by default, to 1 as can be seen on the previous page.

Let's set up columns C3 and C4 to represent the table below.

$x_i$	freq.
3	12
4	19
5	25
6	37
7	15
8	9

Enter the values 3, 4, 5, 6, 7 and 8 into C3 and then 12, 19, 25, 37, 15 and 9 into C4

Now set up your **SYMB** view to look like the one right. Make sure only H3 is checked.

n	C1	C2	C3	C4
1		4		12
2				19
3		5		25
4		6		37
5		7		15
6		8		9

12  
 EDIT INS SORT BIG IVAR STATS

```

STATISTICS SYMBOLIC VIEW
H1: C1      1
H2: C2      1
H3: C3      C4
H4:         1
ENTER SAMPLE
EDIT CHG C SHOW EVAL
  
```

The reason for the last instruction is that only one histogram can be drawn at a time and if more than one data set is checked, only the first one is drawn.

Now use **VIEWS Auto Scale** to plot the graph. You will hopefully find that it looks like the one on the right. The *Auto Scale* function is always very effective in the Statistics aplet and is recommended.

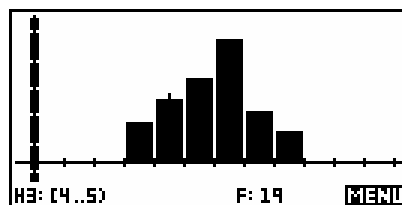

If you use the left/right arrows and look at the bottom of the screen you'll see that the frequencies and ranges are listed. I found that I could tidy this graph up a little by going into **PLOT SETUP** and (on the second page) setting the YTick value to be 5 instead of 1. I also checked the *Labels* option. The result is shown right.

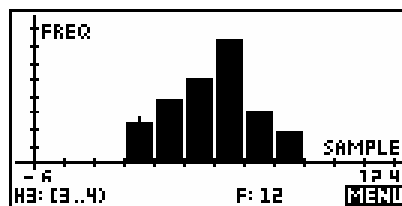

You probably noticed a lot of other options in the first page of **PLOT SETUP**. Their explanations follow.

```

STATISTICS PLOT SETUP
STATPLOT: Hist  HWIDTH: 1
XRNG: - .6      12.4
YRNG: -12.333... 48.9375
HRNG: 3         9
SELECT STATISTICS PLOT TYPE
CHOS PAGE
  
```

The setting of *Statplot* controls what type of graph is drawn. There two choices are *Hist* (short for histogram) or *BoxW* (Box and Whisker). Pressing the **+** key while *Statplot* is highlighted will switch between these two, or you use the **CHOOSE** key to pick from the menu that pops up.



Unlike histograms, it is possible to have more than one box and whisker graph plotted. This makes comparisons between data sets very easy. If you look for the cursor (circled) in the diagram shown right, you will see that when **TRAC** is turned on then information about the graph is given at the bottom of the screen. As usual the up/down arrows change from graph to graph, while the left/right arrows move within the graph.

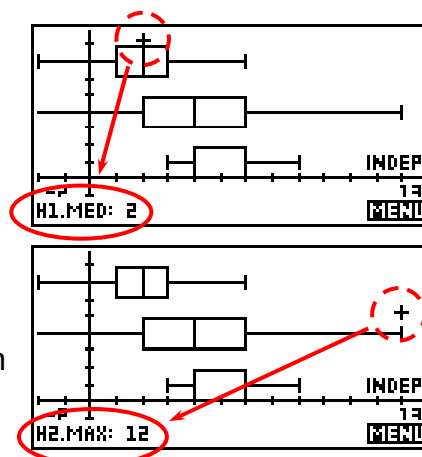

As an aside, pressing the **MENU** key produces the normal tools of **ZOOM**, **TRAC** and **DEFN**. They all behave in the normal manner. The **DEFN** tool can be quite useful by displaying at the bottom of the screen information on which columns make up each graph if you lose track.

Looking again at the screen shot of the first page of **PLOT SETUP** (near the top of the previous page) you will see that there are three ranges. As with the Parametric and Polar aplets, XRange and YRange control how much of the graph is seen. If your histogram has frequencies of (say) up to 30 then you need to make sure your YRange reaches at least that value or the top of the histogram will be cut off. In the same way, if your data has a minimum value of -5 and a maximum of 35 then your XRange will need to cover at least that range of values. Using **VIEW'S Auto Scale** generally produces very satisfactory results.

The effect of HRange is rather different. It controls what range of data is analyzed in calculating the frequencies, and is normally set automatically to be the maximum and minimum values for the data. For example H1 (shown right) has an HRange of -2 to 7. If I go into **PLOT SETUP** and change this to 0 to 7 then the graph loses the left hand column representing the value of -2.

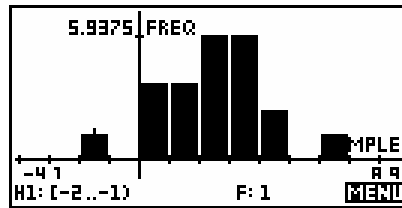

The advantage of this is that it allows you to eliminate outliers from your graph quite easily. However, eliminating them from your graph does not eliminate them from inclusion in the calculation of the values that appear in the **STATS** page. To do that you would need to use **DEL** in the **NUM** view to delete the actual data itself.

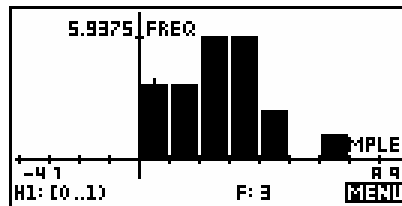

One final note concerns grouped data. We saw earlier how to deal with data displayed in a frequency table, but did not deal with the case where the data was also grouped into intervals or classes.

data	freq
10 - 19	14
20 - 29	26
30 - 39	37
40 - 49	23
50 - 59	17

For example, suppose we want to analyze the set of grouped data in the table on the right.

The hp 39g+ provides some limited methods to deal with data of this form. Summary statistics can be obtained by entering the mid-points of the intervals as the data values but these will only be approximations, as nature of the data itself does not allow calculation of exact values.

n	C1	C2	C3	C4
1	15	14		
2	25	16		
3	35	26		
4	45	37		
5	55	23		
6		17		

Attempting a normal **PLOT** will produce a series of isolated columns, each with width one unit. The reason for this is that the calculator is assuming that there are 14 values of exactly 15 (the mid-point) because it doesn't realize that the columns extend the width of the interval 10 - 19.

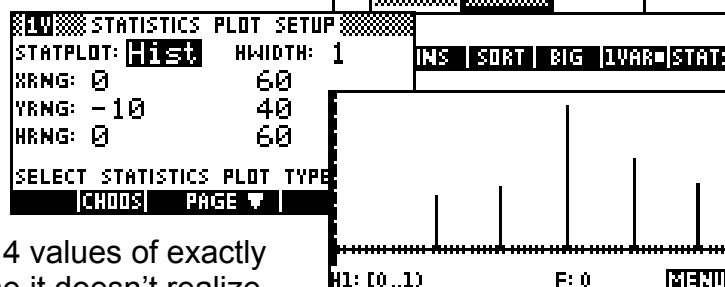

However this can be fixed by using the setting *HWidth*.

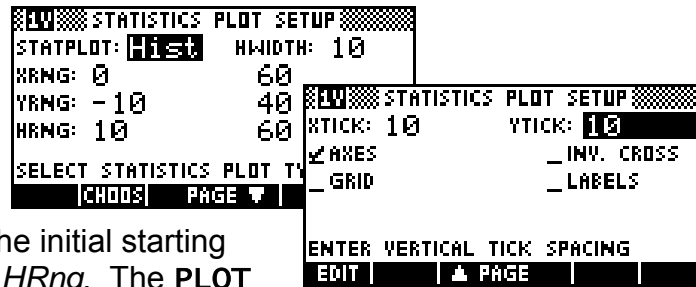

This variable controls the width of the columns, with the initial starting value and end value set by *HRng*. The **PLOT SETUP** views shown above will produce the graph shown below.

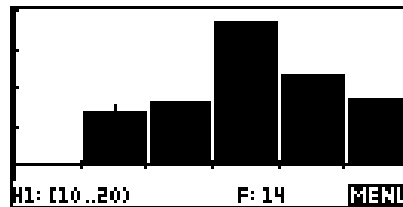



## TIPS & TRICKS - UNIVARIATE DATA

### New columns as functions of old

You have already seen the use of one trick when we created a new column C1 by storing  $2 * C1$  into C2 using the **HOME** view. This can easily be extended to create new columns as functions of any number of others. For example, a set of data that you suspect is exponential could be 'straightened' by storing  $\text{LN}(\text{column})$  into a fresh column. Changes of scale and origin can be investigated in this way by storing (say)  $-2 * C1 + 3$  into C2. You can even combine columns such as  $C1 + C2 \rightarrow C3$ .

If you don't particularly need to see the data as a fresh column, you can use the **SYMB** view to accomplish the same thing in a simpler way. For example, the **SYMB** view snapshot on the right would accomplish the same thing as storing  $2 * C1$  into C2. A histogram of H2 would look the same as the one we produced earlier using the **HOME** view, and the **STATS** command would give exactly the same results. The advantage of this is that it takes much less memory if both columns need not be stored.

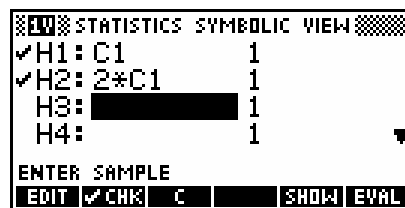

### Simulating Dice

Many of the most common experiments in probability involve the repeated rolling of dice. This can be simulated quite easily in the Statistics applet using the **MATH** menu function **MAKELIST**. (Covered in more detail on page 266)

The syntax is: **MAKELIST**( *expression*, *variable name*, *start*, *end*, *increment* )

where *expression* is the mathematical rule used to generate the numbers.  
*variable name* is the letter (X, Y etc.) that is to be used in the expression (any other letters will be taken as constants).  
*start* is the first value *variable name* is to take.  
*end* is the upper bound for *variable name*.  
and *increment* is the amount that *variable name* should be incremented by in each iteration.

For example: **MAKELIST**( $X^2$ , X, 1, 10, 2)  
would produce { 1, 9, 25, 49, 81 } as X went from 1 to 3 to 5 to ...

This lets you use **MAKELIST** and **RANDOM** to simulate a normal die.

The expression  $\text{INT}(\text{RANDOM} \cdot 6 + 1)$  will simulate one roll of the die. This means that  $\text{MAKELIST}(\text{INT}(\text{RANDOM} \cdot 6 + 1), X, 1, 500, 1)$  will simulate 500 rolls of a normal die. We therefore need only store the resulting list into a Statistics aplet column to analyze and graph it. This is shown in the series of screen shots to the right.

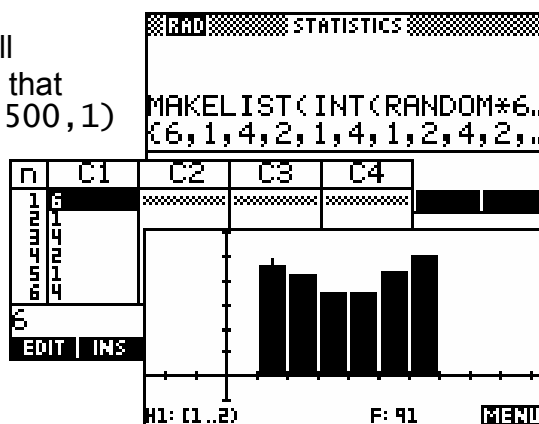

To simulate the adding of two six sided dice, use the similar expression  $\text{MAKELIST}(\text{INT}(\text{RANDOM} \cdot 6 + 1) + \text{INT}(\text{RANDOM} \cdot 6 + 1), X, 1, 500, 1)$

### Simulating Random Variables

It is occasionally handy to be able to simulate a set of observations on random variables of various sorts. This can also be done using the **MATH** menu function **MAKELIST**. (See previous page for syntax. Covered in more detail on page 266)

Example 1: Simulate 100 observations on a  $U[0,1]$  r.v. to be stored in C2.

In the **HOME** view type:  $\text{MAKELIST}(\text{RANDOM}, X, 1, 100, 1) \blacktriangleright C2$

- Note:
1. The  $\blacktriangleright$  symbol is one of the screen keys in the **HOME** view, appearing as **STO** and read as 'store'.
  2. The X is only a dummy variable here to count off the values.

Example 2: Simulate 50 observations on a discrete uniform r.v.  $U[3,7]$

In **HOME** type:  $\text{MAKELIST}(\text{INT}(5 \cdot \text{RANDOM} + 3), X, 1, 50, 1) \blacktriangleright C2$

Example 3: Simulate 50 obs. on a Binomial r.v. with  $n = 20$  and  $p = 0.75$ .

In **HOME** type:

$\text{MAKELIST}(\Sigma(I=1, 20, \text{RANDOM} < 0.75), X, 1, 50, 1) \blacktriangleright C2$

Note: The  $\Sigma$  and the = are both on the keyboard. This will be a relatively slow calculation because it involves evaluating 1000 random numbers.

Example 4: Simulate 100 obs. on a normal  $N(\mu=80, \sigma^2=50)$ .

Ensure that **MODES** is set to radian measure and type:

```
MAKELIST(80+√50*(√(-2*LN(RANDOM))*sin(2*RANDOM)),  
X,1,100,1)▶C2
```

Example 5: Simulate 50 obs. on an exponential distribution (mean = 2).

In the **HOME** view type: `MAKELIST(-2*LN(1-RANDOM),1,50,1)▶C2`

As an illustration, the result of this particular simulation is shown graphically on the right. Its mean turned out to be 2.067 (3 decimal places.). Yours will be different of course - after all, that's the point of using *random* numbers!

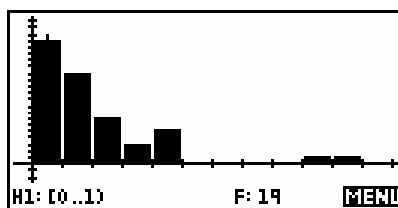

#### Calculator Tip

The **RANDOM** function is not truly 'random' any more than it is on any computer. You can, however, make it as random as possible by using the **RANDSEED** command. For information on this see page 281.

## THE STATS APLET - BIVARIATE DATA

As mentioned in the Univariate section, one of the major strengths of the hp 39g+ is the tools it provides for dealing with statistical data. Unlike the others, the Statistics applet begins in the **NUM** view which offers easy input and editing of values, while the **SYMB** view is reserved for specifying which columns contain data and which ones frequencies, as well as for indicating pairing of columns for bivariate data.

The hp 39g treats univariate and bivariate data quite differently and those differences are reflected in the **SYMB** and **PLOT** views. Because of this the Statistics chapter has been split into two.

The previous section dealt with univariate data and we are now going to look at bivariate (paired) data. On the screen in the **NUM** view of the Statistics applet you will see a key labeled as either **UNVAR** or **BVAR**. Pressing the key under this label changes from univariate (**UNVAR**) to bivariate (**BVAR**) and back. Make sure the key is showing **BVAR** before proceeding.

n	C1	C2	C3	C4
1				

EDIT INS SORT BIC **BVAR** STAT

If your **NUM** view already has some data in it, press **CLEAR** (above **DEL**) and choose *All columns*. The **DEL** key is used to delete individual pieces of data, rather than whole columns. One must be careful when doing this for bivariate data. If your data pairs were in column 1 (C1) and column 2 (C2) then deleting a single piece of data from C1 without deleting its paired element in C2 would destroy the relationship between the two columns.

n	C1	C2	C3	C4
1				

CLEAR...

C1

All columns

CANCEL OK

In this chapter we will use the set of data right to show the use of the bivariate features of Statistics. We will obtain all the usual statistics on it, and draw a scattergram.

$x_i$	$y_i$
1	5
3	10
8	18
5	13
7	16
3	8
6	15
2	8
7	18
9	22
8	17
5	15
7	14
6	18
8	20
5	12
2	8
0	4
7	17
8	19

Move the highlight into column C1 and enter the  $x_i$  values, pressing the **ENTER** key after each one. Now do the same for the  $y_i$  values in C2.

n	C1	C2	C3	C4
1	1	5		
2		10		
3		18		
4		13		
5		16		
6		8		

1  
**EDIT** **INS** **SORT** **BIG** **2VAR** **STATS**

Looking at the bottom of the screen you will see a series of tools provided for you. As before, **EDIT** is not worth bothering with.



**Calculator Tip**  
 You can enter the  $x_i$  and  $y_i$  data into both columns simultaneously if you enter it as ordered pairs in brackets. i.e. as ( 1 , 5 ) **ENTER** ( 3 , 10 ) **ENTER** etc. In fact, you can even leave off the closing bracket! The calculator will complete it for you.

We could use **VIEW**s and *Auto Scale* to produce a plot (this generally produces very satisfactory results), but let's have a look at the **PLOT SETUP** screen instead.

```

EW STATISTICS PLOT SETUP
XRNG: -3      10
YRNG: -5      25
S1MARK: .    S2MARK: x  S3MARK: +
S4MARK: ::   S5MARK: x
ENTER MAXIMUM VERTICAL VALUE
EDIT PAGE
    
```

As you can see, it is very similar to the other **PLOT SETUP** screens that we have encountered with the main difference consisting of the list of settings for S1MARK, S2MARK etc. These are the markings that are to be used in plotting the points, allowing you to choose different markings for different data sets if you are graphing multiple data sets.

Set your **PLOT SETUP** screen so that it looks like the one shown above right, also switching to the second page and ensuring that it is checked as shown right and setting *YTick* to 5.

```

EW STATISTICS PLOT SETUP
XTICK: 1      YTICK: 5
CONNECT      INV. CROSS
AXES        LABELS
GRID
ENTER HORIZONTAL TICK SPACING
EDIT PAGE
    
```

If you now press **PLOT** you will see the result shown right. If you look at the screen you will see a small cross and, at the bottom of the screen, a listing of **S1[1]: 1,5**. This is telling you that the cross is currently on the first point in data set S1 whose value is (1,5). Using the left/right arrow keys you can move this cross through the data set with the values being reported at the bottom of the screen.

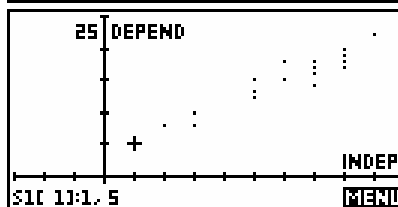

If you have more than one data set displayed on the screen then the up/down arrows move from one set to the other, unless the fit line is also showing in which case the behavior is slightly different. Information is given later on how to display the fit curve and to choose the type of curve.

As usual, the **MENU** key produces a list of further options. The key labeled **INS** inserts space for a new number by shifting all the numbers down one space. If working with bivariate data you will need to also insert into the paired column.

The **STAT** option is capable of dealing with bivariate data if you are careful to enter the column number of the dependent column into the appropriate space. The **CHOOSE** key will pop up a list of columns from which to choose, or you can use the **ALPHA** key.

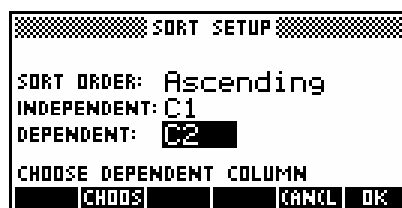

Although we bypassed it in the previous example, part of the procedure in dealing with bivariate data is to specify the relationships between columns before plotting. This is done via the **SYMB** view as it is for univariate data.

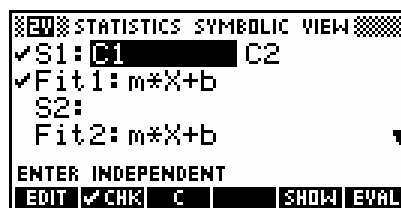

The S1:, S2: ... refer to data sets 1, 2... This allows you to display more than one set of bivariate data by specifying the columns for each set. Columns can be used in more than one set. Note that a 'C' screen key is provided for your convenience.

The screen above shows the default setup when you **RESET** the applet in the **APLET** view. It specifies that columns C1 and C2 are paired and that a linear fit ( $m \cdot X + b$ ) is to be used when calculating a line of best fit. This was all that was required for our previous example and so I bypassed that step for simplicity.

If you intend to use other columns then you must register them in the **SYMB** view. For example, to use data entered into C3 and C4 you must register them as shown.

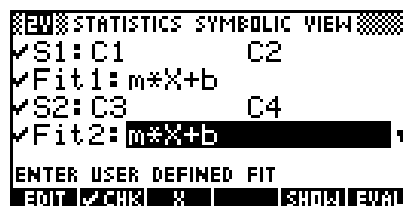

## Choosing from available fit models

On the hp 39g+ the Statistics applet is the only one which has a **SYMB SETUP** view, and even then only in **EQWARR** mode. This view is supplied to allow you to specify what type of fit equation is to be used. The choices are:

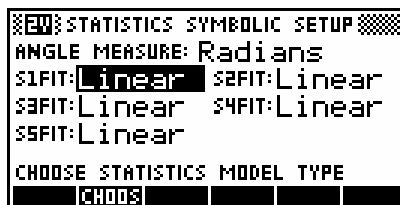

- Linear* -  $m \cdot X + b$  ( $Y = mX + b$ )
  - Logarithmic* -  $m \cdot \text{LN}(X) + b$  ( $Y = m \ln(X) + b$ )
  - Exponential* -  $b \cdot \text{EXP}(m \cdot X)$  ( $Y = b e^{mX}$ )
  - Power* -  $b \cdot X^m$  ( $Y = b X^m$ )
  - Quadratic* -  $a \cdot X^2 + b \cdot X + c$  ( $Y = aX^2 + bX + c$ )
  - Cubic* -  $a \cdot X^3 + b \cdot X^2 + cX + d$  ( $Y = aX^3 + bX^2 + cX + d$ )
  - Logistic* -  $L / (1 + a \cdot \exp(-b \cdot X))$  this fits the data to a logistic curve ( $Y = \frac{L}{1 + a e^{-bX}}$ ) where L is the saturation value.  
(see tip below)
- and - *User Defined* - discussed below.



### Calculator Tip

1. If you want L calculated automatically, pre-store a value of zero into it. If the value is known, you can store a positive real value into memory L prior to the curve fit.
2. If you calculate a line of best fit and want to remove the resulting equation from the **SYMB** display and return to the ' $m \cdot X + b$ ' display then just position the highlight on the relevant 'Fit:' line and press the **DEL** key. When you do this, the **CHK** will be removed and will have to be reset.

## The User Defined model

When you set the model to user defined it means that you are expected to supply the complete equation, including the values of any coefficients. The calculator will not calculate the values of any variables you include. For example, if you were to supply an equation of  $A/(X - B)$  as your model then the calculator would use the values of A and B currently in memory.

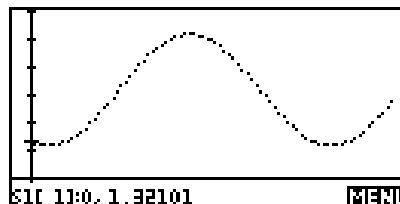

This may seem to be a useless model but it can be quite useful. For example, suppose you had collected a set of data using a data logger and a motion detector which you suspected might represent simple harmonic motion.

There is no trig model supplied in the list of models built-in but some work and experimentation may allow us to find a valid model and test its fit.

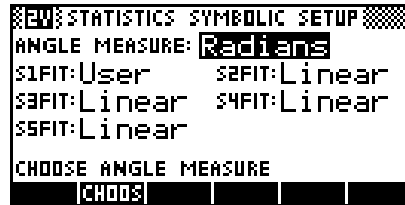

If we change into **SYMB SETUP** view and select *User Defined* and then change back to **SYMB** view then we can insert our model as the fit curve. How to deduce the parameters in this model I leave to you!

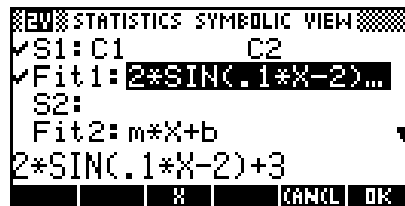

As you can see in the new **PLOT** view, the curve we have deduced fits the data quite well. How well is a matter for your judgment, aided by the **ReTErr** variable (see page 141).

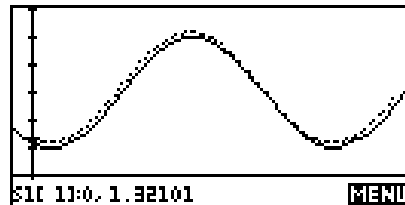

### Connected data

One of the settings on the second page of the **PLOT SETUP** screen can be useful for some types of data. For example, one of the common tasks in many mathematical courses is the analysis of time series data. Unlike most bivariate data, time series values are usually plotted as a line graph - i.e. as connected points. This facilitated by *Connect*.

For example:

The sales of an ice-cream shop are shown as quarterly sales figures for the years 1992 to 1993. Display this data on a graph.

Yr Qtr	1992				1993			
	1	2	3	4	1	2	3	4
Sales (\$1000)	12	18	20	15	13	20	23	16

The result (with *Connect* checked) is shown right. The X values were entered as 1, 2, 3, 4, 5, 6, 7, 8 rather than 1, 2, 3, 4, 1, 2, 3, 4.

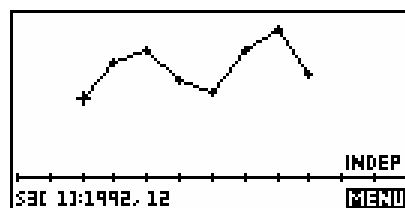





### Calculator Tip

If you have trouble seeing the small dots that the hp 39g+ uses in its scatter-graphs by default then you will be interested in the settings circled on the right. If you move the highlight onto the mark for the data set you are using and press **CHOOSE** then you will see the menu shown right from which you can choose a different mark. The contrast is illustrated below.

### Two Variable Statistics

As with univariate statistics, summary statistics are available through the **STATS** key in the NUM view (see right).

n	C1	C2	C3	C4
1				
NUM				
STATS				
6				
1				
EDIT	INS	SORT	BIG	2VAR
				<b>STATS</b>

Pressing this key changes to a screen which lists the following: MEANX,  $\Sigma X$ ,  $\Sigma X^2$ , MEANY,  $\Sigma Y$ ,  $\Sigma Y^2$ ,  $\Sigma XY$ , SCOV, PCOV, CORR and RELERR.

See page 141 for information on RelErr.

2-VAR	S1		
MEANX	3.7		
$\Sigma X$	22		
$\Sigma X^2$	173		
MEANY	4.2		
$\Sigma Y$	25		
$\Sigma Y^2$	116		
RELERR	3.7		
			OK

Let's use the set of data shown in the table on the right to go through the analysis process a second time and this time examine the line of best fit. The data is also listed in the box below.

$X_i$	$Y_i$
1	2
1	3
2	2
5	7
6	6
5	7
4	3
5	6
6	4
2	2

Enter the data into the **NUM** view and then switch to the **SYMB** view. Make sure that S1 (data set 1) is set to C1 and C2,  **CHK**ed, and that the fit is linear. If not, the fit can be changed in the **SYMB SETUP** view.

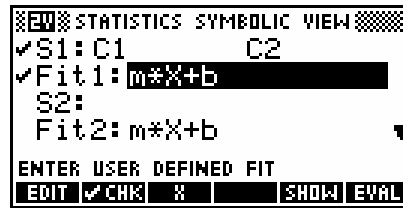

Now change to **PLOT SETUP** view and set the axes to be as shown right.

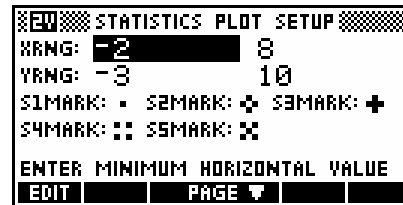

From the **NUM** view, press the **STATS** key and you will obtain the results listed in the two screens shown below.

2-VAR	S1		
MEANX	3.7		
EX	37		
EX2	173		
MEANY	4.2		
EY	42		
EY2	216		
3.7			
			OK

2-VAR	S1		
EY2	216		
EXY	185		
SCDV	3.288889		
PCDV	2.96		
CORR	.7828216		
RELER	.0709706		
7.09705550431E-2			
			OK



#### Calculator Tip

Make sure that your data set is defined and  **CHK**ed in the **SYMB SETUP** view before you try to obtain these results. Results are only given for data sets that are defined and and  **CHK**ed.

If you now press the **PLOT** key you will see the graph shown right. If there is no line of best fit on yours, press the **MENU** key to get the list of programmable functions along the bottom of the screen and then press the **FIT** key.

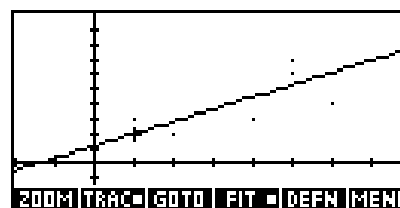

As soon as the line of best fit has been obtained, you can switch back to the **SYMB** view to get its equation. This equation is only calculated when called for by pressing the **FIT** key.

In the **SYMB** view (see right) the equation is given to so many decimal places that it doesn't fit onto the screen. The simplest way to see the entire equation is to position the highlight on the equation and press the **SHOW** key.

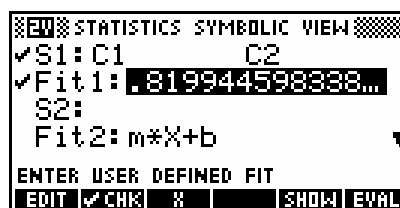

When you do you will obtain the view seen right which gives the equation of the line of best fit as  $\hat{y} = 0.8199x + 1.1662$ . With a correlation coefficient of 0.7829 (from the summary stats seen previously) this would probably not be regarded as reliable.



On the screen above the equation is given to 4 decimal place accuracy. This is accomplished by changing to the **MODES** screen (above the **HOME** key) and specifying 'Fixed 4' as the Number Format. If you don't do this then you can use the arrow keys to scroll the equation left or right if it extends off the screen.

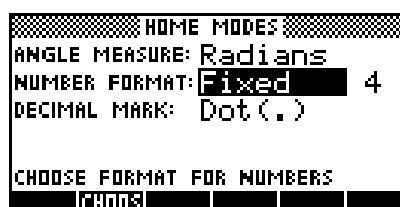



**Calculator Tip**  
 One of the most common mistakes people make is to press **EDIT** instead of **SHOW**. Always use **SHOW** when you want to display the entire equation. An explanation is given below.

It is very important that you display the equation in the **SYMB** view by pressing **EDIT** instead of **SHOW**. Although pressing **EDIT** displays the equation in a form which can be scrolled through problem with this method is that the calculator thinks that you are choosing to over-ride its choice of equation with your own by editing it. As long as you press **CANCEL** there is no problem but if you press **ENTER** it changes the FitType from whatever you chose to 'User Defined'.

If you are not aware that this has happened then it can have very serious consequences. For example, if you were now to change the data and then re-plot, the fit equation will not be re-calculated and will become inaccurate.

We can make predictions from our line of best fit in two places - the **HOME** view and the **PLOT** view. The hp 38g was able to do this only from the **HOME** view.

In the **HOME** view we use the functions **PREDY** and **PREDX** from the Stat-Two section of the **MATH** menu. The functions **PREDX** and **PREDY** use whatever was the last line of best fit calculated. It is up to you to ensure that the one you want used was the one last graphed. If I want to predict a y value for  $x = 3$ , then I simply type **PREDY(3)** into the **HOME** view as shown right.

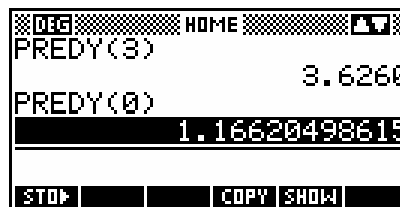

Many people choose to simply type 'PREDY' using the **ALPHA** button instead of going through the **MATH** menu.

Using the **PLOT** view is probably the more visually appealing method of obtaining predicted values. When you have plotted a set of data and its fit curve then pressing up arrow will change the focus of the values at the bottom of the screen from the data points to the **PREDY** values. In the screen snapshots shown right the focus changes from data point 3 (2,2), to the **PREDY** value for  $x = 2$  of 2.806.

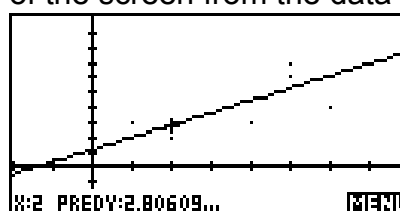
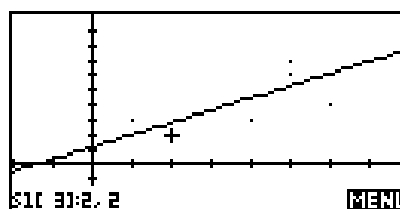

If there is more than one data set (and fit lines) graphed then the up arrow will move progressively from one to another and finally back to the first.

Pressing left and right arrows will move along the fit line but only on pixel positions, which may not be suitable if the scale is not chosen carefully. A better way is to use the **FUTU** key to obtain **PREDY** values for any required value of  $x$ , including values which would normally be off-screen.

Another aspect of bivariate stats needs to be remembered when the fit chosen is not linear. Mathematically, the correlation coefficient is a strictly linear measure of the goodness of fit and this means that the correlation coefficient quoted in the **STATS** view is *always* for the linear model even when the model chosen is not linear.

There are two methods of dealing with this. The first is to use another measure of goodness of fit. The second is to 'linearize' the data (discussed below). The hp 39g+ provides an alternative measure of goodness of fit via the `RelErr` value in the `STATS` view.

`RelErr` is defined as the measure of the relative error in predicted values when compared to data values, and has the formula shown right. The  $\hat{y}$  values are obtained using the `PREDY` function internally. The only drawback to `RelErr` is that there is no upper limit its value of as there is for the correlation coefficient. The interpretation placed on it is that the closer it is to zero the better the model fits the data. This value is available for any of the data models, including the user defined model.

$$\text{RelErr} = \frac{\sum_{i=1}^n (y_i - \hat{y})^2}{\sum_{i=1}^n y_i^2}$$

Alternatively, when data is non-linear in nature you can transform the data mathematically so that it *is* linear. Let's illustrate this briefly with exponential data.

$x_i$	$y_i$
1	2
2	4
3	8
4	16
5	32
6	64

As you can see, I chose a very simple rule for the data:  $y = 2^x$

n	C1	C2	C3	C4
1	2	4		
2	4	8		
3	8	16		
4	16	32		
5	32	64		
6	64			

1  
 EDIT INS SORT BIG 2VAR STATS

If you set up a linear fit for the data in S1, and then view the bivariate stats, you will find that the correlation for a linear fit is 0.9058

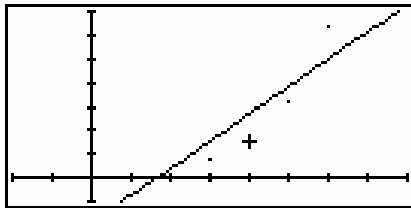

As you can easily see from the graph left, a linear fit is not a very good choice.

If we change now to the `SYMB SETUP` view and choose an Exponential fit rather than a linear fit then the results are far better.

```

  STATISTICS SYMBOLIC SETUP
  ANGLE MEASURE: Radians
  S1FIT: ExpFit  S2FIT: Linear
  S3FIT: ExpFit  S4FIT: Linear
  S5FIT: Linear
  CHOOSE STATISTICS MODEL TYPE
  CHOOS
  
```

The curve which results in the **PLOT** view is exactly what is required and the equation comes out as  $Y = 1 \cdot \text{EXP}(0.693147X)$

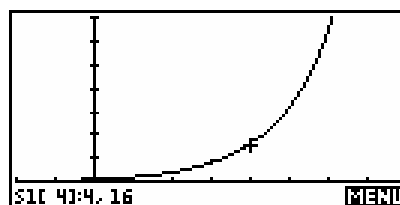

This “EXP(“ is the calculator’s notation for  $Y = 1 \cdot e^{0.693147X}$  which then changes to  $Y = 2^X$ .

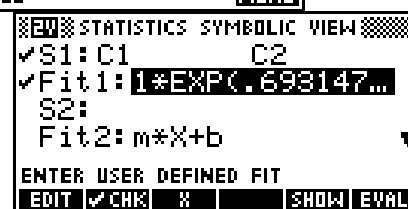

Checking the **STATS** key shows that the correlation is unchanged at 0.9058 even when the new equation clearly fits the data perfectly.

The value of **Re1Err** on the other hand has changed from 0.09256 for the linear fit, to a value of zero for the exponential model.

The alternative to using **Re1Err** is to graph column **C1** against **ln(C2)** which also straightens the data.

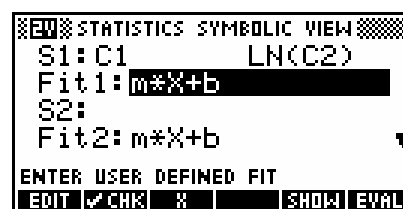

‘Linearizing’ will cause problems if some of the data points are outside the domain of the function you use, such as negative values in a log function. On the other hand, you have far more control if you are able to choose the exact function. For example, if you had a set of data which was derived from cooling temperatures then you would probably find that it was asymptotic to room temperature rather than the x-axis. The built-in equation assumes that the data is asymptotic to the x axis and would not give a good fit. You could get better results by subtracting a constant from the whole column first.

## TIPS & TRICKS - BIVARIATE DATA

### New columns as functions of old

As with univariate statistics, you can use functions of old columns as new sets of data. See the Univariate version of this section for two different ways of doing this.

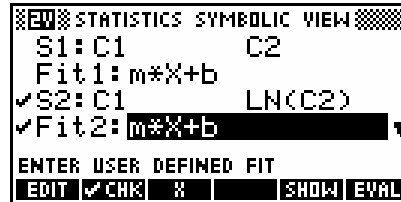

For example, a set of data (C1, C2) that you suspect is exponential could be straightened by setting up S2: as (C1, LN(C2)).

The effects of changes of scale and origin on data and summary statistics can be investigated in this way by storing (say)  $-2 * C2 + 3$  into C2. You can even combine columns in this way, such as storing  $C1 + C2$  into C3.

### Using values from **STATS** in calculations

It is often useful to be able to retrieve values such as the mean and standard deviation for use in further calculations. With most simpler calculators these values are found by pressing keys rather than reading from a **STATS** screen, so doing a calculation like 'multiply the mean by 3.5' is not hard. The values shown on the **STATS** screen can also be retrieved for use on the hp 39g+ relatively easily.

For example, the set of data below contains a suspected outlier (erroneous value). In this case one might suspect a missing comma.

{2, 3, 5, 2, 1, 5, 3, 6, 7, -2, 3, 5, 5, 55}

A common test for outliers is to calculate the mean and standard deviation without the presence of the suspected outlier, and then to check whether the suspect piece of data is within three standard deviations of the mean. If not, then it is discarded.

n	C1	C2	C3	C4
1				
2				

STATS

EDIT INS SORT BIG LVAR STATS

Enter the data without the suspected outlier into column C1 with the calculator in **LVAR** mode. Ensure that the **SYMB** view is set up correctly and then press the **STATS** key.

As you can see on the right, the values of the mean and standard deviation are given in the **STATS** screen to 12 significant digits.

1-VAR	H1		
ME	13		
TOTΣ	45		
MEANΣ	3.461538		
PVARΣ	5.325444		
SVARΣ	5.769231		
PSDEV	2.307692		
13			
OK			

If we now switch to the **HOME** view, we can recall these values and use them in a calculation to find the upper and lower cut off points for acceptance of data.

As you can see on the left, the range for acceptance is -3.46 to 10.38, which makes the value of 55 almost certainly an error.

STATISTICS	
MeanΣ+3*PSDev	10.3846153846
MeanΣ-3*PSDev	-3.46153846153
STOP	

There are two ways to obtain these values. You can type them into the **HOME** view using the **ALPHA** key, or you can use the **VARΣ** key instead. If you press **VARΣ** and then the screen key labeled **APLET** then, assuming the Statistics applet is active, you will see the view above right. Scroll down to the *Stat-One* variables and then press the right arrow. This puts you in the list (see right) of univariate summary statistics. If you highlight one and press **ENTER** then the variable name will be pasted into the **HOME** view for use. People often find it easier to simply type them.

STATISTICS VARS	
Plot	Axes
Symbolic	Connect
Numeric	Coord
Note	Grid
HOME   APL   NAM   VAL   CANCL   OK	

STATISTICS VARS	
Note	MaxΣ
Sketch	MeanΣ
Stat-One	Median
Stat-Two	MinΣ
HOME   APL   NAM   VAL   CANCL   OK	



### Calculator Tip

The values of the mean and standard deviation retrieved are those of the *last set calculated*. If you have more than one set of data in the **NUM** view then firstly un-**CHK** all except the one you want, and secondly press the **STATΣ** key in order to force a calculation of the values you want. This ensures that the ones you retrieve in the **HOME** view are the ones you want.

This technique can also be used for bivariate data in exactly the same manner. You should ensure, as per the note above, that only the set of data you want to use is **CHK**ed and that **STATΣ** have been displayed for it.

All the usual values are retrievable, with the exception that there is no way to provided to retrieve the coefficients of the line of best fit, since they appear in the **SYMB** screen rather than the **STATΣ** screen.



Coefficients can be obtained from the chosen fit model algebraically. The function PREDY from MATH gives a predicted  $y$  value *using the last line of best fit that was calculated*. This means that you must use the SYMB view to ensure that your set of data is the only one CHKed and make sure SYMB SETUP is set to the correct fit model, and also use the PLOT screen and the **FIT** key to ensure that your set of data was the last one graphed and that it has had its curve of best fit displayed. Until the curve has been displayed, the coefficients are not available or, worse, might belong to another data set.

If the line of best fit is  $y = m * X + b$  (see the SYMB screen) then the calculations shown below and right will give the slope and y-intercept.

$$PREDY(0) = m * 0 + b$$

$$= b$$

$$\text{and } PREDY(1) - PREDY(0) = (m * 1 + b) - (m * 0 + b)$$

$$= m + b - b$$

$$= m$$

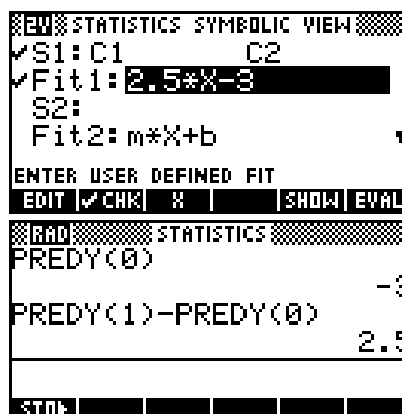

### Finding Fit Coefficients

Linear -  $m * X + b$   
 $b = PREDY(0)$   
 $m = PREDY(1) - PREDY(0)$

Logarithmic -  $m * \ln(X) + b$   
 $b = PREDY(1)$   
 $m = PREDY(e) - PREDY(1)$

Exponential -  $b * \exp(m * X)$   
 $b = PREDY(0)$   
 $m = \ln(PREDY(1) / PREDY(0))$

Power -  $b * X^m$   
 $b = PREDY(1)$   
 $m = \ln(PREDY(e) / PREDY(1))$

Quadratic -  $a * X^2 + b * X + c$   
 $a = (PREDY(2) - 2 * PREDY(1) + PREDY(0)) / 2$   
 $b = (PREDY(2) + 4 * PREDY(1) - 3 * PREDY(0)) / 2$   
 $c = PREDY(0)$

or, 
$$\begin{bmatrix} a \\ b \\ c \end{bmatrix} = \begin{bmatrix} 0 & 0 & 1 \\ 1 & 1 & 1 \\ 4 & 2 & 1 \end{bmatrix}^{-1} \times \begin{bmatrix} PREDY(0) \\ PREDY(1) \\ PREDY(2) \end{bmatrix}$$

Cubic -  $a * X^3 + b * X^2 + c * X + d$   

$$\begin{bmatrix} a \\ b \\ c \\ d \end{bmatrix} = \begin{bmatrix} 0 & 0 & 0 & 1 \\ 1 & 1 & 1 & 1 \\ 8 & 4 & 2 & 1 \\ 27 & 9 & 3 & 1 \end{bmatrix}^{-1} \times \begin{bmatrix} PREDY(0) \\ PREDY(1) \\ PREDY(2) \\ PREDY(3) \end{bmatrix}$$

### Correct interpretation of the PREDX function

The PREDX function in the MATH menu simply reverses the line of best fit.

For example, the equation  $\hat{Y} = 0.8199X + 1.1662$  earlier would use

$$\hat{X} = \frac{(Y - 1.1662)}{0.8199} \text{ to predict the X values.}$$

Whether this is mathematically correct depends on how you interpret the PREDX function. If, as HP intended, you interpret it to mean “give me an x value which, if used in the PREDY function, would give me this y value”, then it is correct. However, it should not be interpreted to mean “predict an x value based on this y value”.

It should not be felt that the hp 39g+ is unusual in this interpretation. Most calculators' equivalent of the PREDX function behave in the same manner.

The reason for not using the second interpretation is that the results it gives would then be incorrect. The line of best fit (unlike the correlation) changes as the independent and dependent variables swap roles and can't be simply reversed in this way.

The formula for the slope  $b$  in the line of best

fit  $\hat{y} = a + bx$  is given by the formula:  $b = \frac{S_{xy}}{(S_x)^2}$ .

While the value of  $S_{xy}$  will not change if the

roles of independent and dependent columns are reversed, the value of

$(S_x)^2$  on the bottom means that this formula will give a different value if you change which column is regarded as x (indep.) and which as y (dependent).

This different value for  $b$  will also mean a different value for  $a$  and these will not be the values which would result from the simple inverse function.

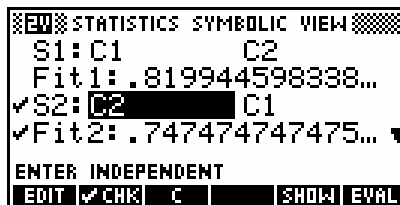

If you truly wish to predict X values in the sense of the second interpretation, then you should change to the SYMB view and enter a new data set S2 which uses C2 and C1 in reversed order, avoiding the need to re-enter the data.

Now use PREDY rather than PREDX. As you can see in the screen below, the result of PREDX(5) with C1 vs. C2 is not the same as PREDY(5) using C2 vs. C1.

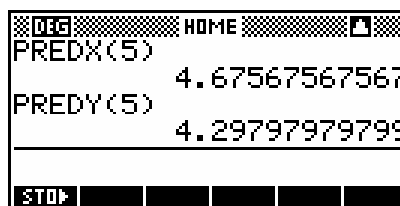

## Assigning rank orders to sets of data

It is occasionally handy to be able to assign rank orders to a set of data. You might be running a Quiz Competition Night, or recording times for the 100 meter sprint, but in either case it is handy to be able to sort the data into descending order and assign rankings. This is easy for small sets of data, but becomes difficult for larger sets.

Let us assume a set of 20 competitors in the 100 meter sprint, with times recorded to two decimal places, and competitors numbered 1 to 20. Suppose that the results were as shown right...

Competitor	Time
1	12.23
2	11.47
3	11.34
4	12.87
5	12.23
6	11.30
7	10.51
8	11.34
9	11.46
10	12.34
11	12.23
12	11.50
13	12.01
14	11.97
15	12.05
16	12.87
17	12.02
18	12.52
19	11.37
20	10.75

Enter the competitor numbers as column C1 and the times in column C2. I'm going to assume here that the competitor numbers also run from 1 to 20 but this may not be the case. In addition to this, put the numbers 1 to 20 into column C3 also. This can be a bit tedious to type in for lists longer than 20, so you could use the expressions `MAKELIST(X,X,1,20,1)` in C1 and `C1` in C3 to shortcut the process, replacing 20 with whatever is needed. Make sure that the **2VAR** option is selected.

n	C1	C2	C3	C4
1	1	12.23	1	
2	2	11.47	2	
3	3	11.34	3	
4	4	12.87	4	
5	5	12.23	5	
6	6	11.30	6	

The result should look like this...

Now position the highlight on column C2 and press the **SORT** key. In the **SORT SETUP** screen (shown below right) enter C1 as the Dependent column. This will have the effect of pairing columns C1 and C2 and then

sorting column C2 into ascending order, re-arranging column C1 to reflect the changes. When ready, press **OK**. The results of this sort are shown right.

The final column C3 has not been re-arranged. With a few alterations, it contains the rankings. Looking down the column it can be seen that there are two values of 11.34 (the 4<sup>th</sup> and 5<sup>th</sup>). Their ranking should therefore both be changed to 4. Continuing this process down the length of column 3 will produce the rankings for the whole 20 competitors.

n	C1	C2	C3	C4
1	7	10.51	1	
2	20	10.75	2	
3	6	11.30	3	
4	8	11.34	4	
5	8	11.34	4	
6	19	11.37	5	

### Using Stats to find equations from point data

eg. 1 Find the equation of the quadratic which passes through the points (1,5), (3,15) and (-5,71).

n	C1	C2	C3	C4
1	1	5		
2	3	15		
3	-5	71		

EDIT	INS	SORT	BIG	EVAR	STATS
STATISTICS SYMBOLIC SETUP					
ANGLE MEASURE: Radians					
S1FIT: QuadFit		S2FIT: Linear			
S3FIT: Linear		S4FIT: Linear			
S5FIT: Linear					
CHOOSE STATISTICS MODEL TYPE					
CHOOSE					

In the Statistics aplet, choose **EVAR** mode and enter the data. Now change to the **SYMB SETUP** view and choose the *Quadratic* data model.

Change to the **PLOT** view using the **VIEWS Auto Scale** option and press the **FIT** key. Don't worry that the scale is not good because we don't care about the graph. It only needs to be drawn in order to calculate the fit equation.



Finally, change back to the **SYMB** view and see the equation, pressing **SHOW** if necessary.

STATISTICS SYMBOLIC VIEW					
S1: C1		C2			
Fit1: 2*X^2-3*X+6					
S2:		Fit2: m*X+b			
ENTER USER DEFINED FIT					
EDIT	CHK	X	SHOW	EVAL	

eg. 2 A population of bacteria is known to follow a growth pattern governed by the equation  $N = N_0 e^{kt}$ ;  $t \geq 0$ . It is observed that at  $t = 3$  hours, there are 100 colonies of bacteria and also that at  $t = 10$  hours there are 10 000 colonies.

- Find the values of  $N_0$  and of  $k$ .
- Predict the number of bacteria colonies after 15 hours.
- How long does it take for the number of colonies to double?

n	C1	C2	C3	C4
1	3	100		
2	10	10000		

3				
EDIT	INS	SORT	BIG	

  

STATISTICS SYMBOLIC SETUP					
ANGLE MEASURE: Radians					
S1FIT: ExpFit		S2FIT: Linear			
S3FIT: Linear		S4FIT: Linear			
S5FIT: Linear					
CHOOSE STATISTICS MODEL TYPE					
CHOOSE					

(i) Find  $N_0$  and  $k$ .

Start up the Statistics aplet, set it to **EVAR** and enter the data given. Change to the **SYMB SETUP** view and specify an *Exponential* model for the data.

Either use the **VIEWS Auto Scale** option, or change to the **PLOT SETUP** view and adjust it so that it will display the data. This is not really needed, since the line of best fit is what we need and it will be calculated even if the data doesn't show.

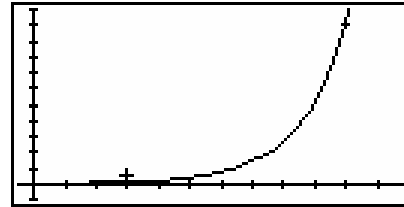
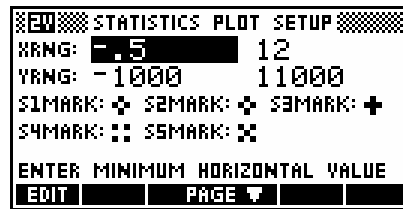

Now change to the **PLOT** view and press **FIT**. Wait while the line draws.



Change to the **SYMB** view, move the highlight to the equation of the regression line and press **SHOW**. Rounded to 4 dec. places, this gives an equation of  $N = 13.8950 e^{0.6579t}$ .

(ii) Predict  $N$  for  $t = 15$  hours.

Change to the **HOME** view and use the **PREDY** function or use the facilities in the **PLOT** view.

Result: 268 269 colonies.

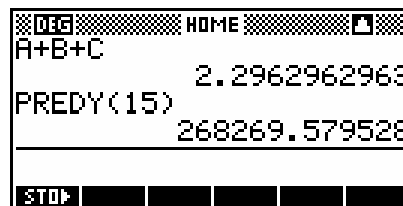

(iii) Find  $t$  so that  $N = 2N_0$ .

The value of  $N_0$  is the  $y$  intercept of the line of best fit. These values from the curve of best fit are not directly accessible but can be retrieved using the **PREDY** function (see page 145). This is shown in the screen shown right. Store the results into memories **A** and **K**. This saves having to re-type them from the **SHOW** screen.

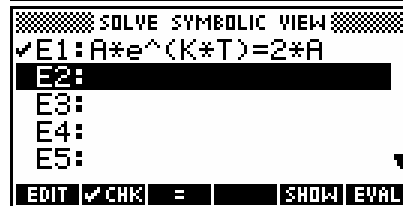
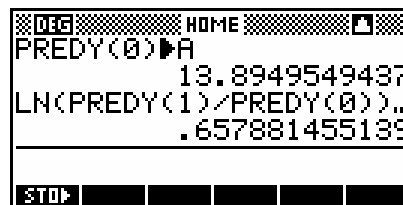

Now switch to the Solve applet and enter the equation to be solved. Changing into the **NUM** view, you should find the values of **A** and **K** already defined (that was why we stored the curve values into the appropriate memories), so move the highlight to **T** and press **SOLVE**.

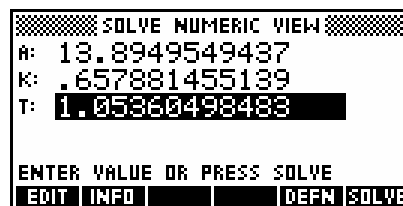

Result: Doubling time is 1.0536 hours.

## THE INFERENCE APLET

This applet is a very flexible tool for users investigating inference problems. It provides critical values for hypothesis testing and confidence intervals, and does this not only quickly but in a visually helpful format.

Before we look at the Inference applet in detail I am going to take a small digression to look at a simple inferential problem which can be solved using only the Statistics and Solve applets.

*“Four coins are tossed 400 times and the number of heads noted for each toss. The results are shown below. Using the  $\chi^2$  test at a 5% level of confidence, indicate whether the coins may be biased.”*

Number of heads	0	1	2	3	4
Frequency	32	112	158	90	8

We would expect that for an un-biased set of coins the distribution would be binomial. Our hypotheses are:

$H_0$ : The number of heads is binomially distributed ( $n=4$  &  $p=0.5$ )

$H_A$ : The number of heads is *not* binomially distributed ( $n=4$  &  $p=0.5$ )

Begin by entering the data into the first two columns of the Statistics applet (right).

We now need to calculate the expected values based on our null hypothesis. We can do this in the HOME view using the calculation shown right (and below), inserting the results into column C3.

$$400 * \text{COMB}(4, C1) * .5^{C1} * .5^{(4-C1)} \blacktriangleright C3$$

We can now calculate the  $\chi^2$  value using the calculations shown right, which places the individual values into column C4 for inspection if required.

n	C1	C2	C3	C4
1	0	32		
2	1	112		
3	2	158		
4	3	90		
5	4	8		

EDIT | INS | SORT | BIG | IVAR | STATS

RAD STATISTICS

400\*COMB(4,C1)\*.5^C1\*...  
(25,100,150,100,25)  
...)\*.5^C1\*.5^(4-C1)▶C3

STOP

RAD STATISTICS

(C2-C3)^2/C3▶C4  
{1.96,1.44,.426666666...  
ZLIST(C4)  
16.3866666667

n	C1	C2	C3	C4
1	0	32	25	1.96
2	1	112	100	1.44
3	2	158	150	.426667
4	3	90	100	1
5	4	8	25	11.56

EDIT | INS | SORT | BIG | IVAR | STATS

The values can be seen by changing to the **NUM** view.

In the **MATH** menu, *Probability* section, there is a function called **UTPC** (Upper-Tailed Probability Chi-squared) which will give the critical  $\chi^2$  probability for a supplied number of degrees of freedom and a value. See page 283. In this case we would like the value for a given probability so we will enter the formula into the Solve aplet.

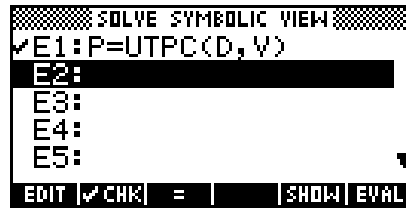

Change to the **NUM** view, enter the known parameters of  $D=4$  and  $P=0.05$ , and **SOLVE** for the critical  $\chi^2$  value.

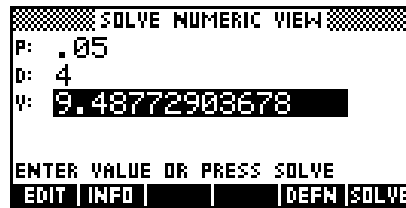

Since our value of 16.387 is larger than the critical value of 9.488 we conclude that we must reject the null hypothesis and judge that the observed values do not follow this binomial distribution and hence that the coin is probably biased. This does not say that it is not binomially distributed; just not with those parameters.

As can be seen from this example, the Statistics and Solve aplets can be used for simple problems, particularly in cases where working is required to be shown. For more complex problems the Inference aplet provides more powerful tools.

### **Hypothesis test: T-Test $1-\mu$**

A company makes boxes of matches which are supposed to contain an average of 50 matches. A student has counted the contents of 20 boxes and found the results below. Using a 5% confidence level, decide whether the claim is correct.

n	C1	C2	C3	C4
1	47			
2	50			
3	52			
4	51			
5	53			
6	51			
47				
EDIT   INS   SORT   BIG   IVAR=STATS				

47, 50, 52, 51, 53, 51, 49, 49, 52, 53, 54, 48, 53, 55, 52, 54, 54, 53, 48, 48

Enter the data into the Statistics aplet then change to the Inference aplet.

Choose the test and the alternate hypothesis in the **SYMB** view of the Inference applet.

In this case we are working with a single sample and we do not know the standard deviation of the underlying population, so we will use the Student-t test and the alternate hypothesis that the mean of the real underlying population from which the sample was drawn is not equal to that of the proposed underlying population.

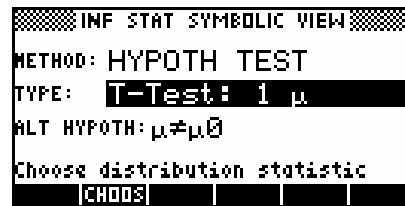

Change now to the **NUM SETUP** view to enter the required values. Rather than entering them by hand, press the **IMPORT** key. If you have more than one copy of the Statistics applet (under other names) then you will be presented with a list of applets from which to choose.



Once you have chosen the applet, you need to nominate the column from which to import the data. The default is column **C1**, which is what we want in this case, but you can press the **CHOOS** key to select from a list of any other columns which contain data. When you have the correct column, press **OK**.

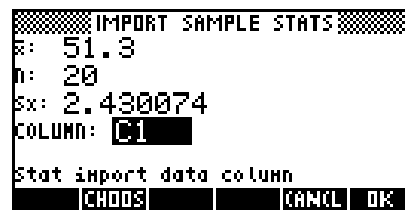

Enter the population mean  $\mu_0 = 50$ , and check that the test level is correct at 0.05 (5%).

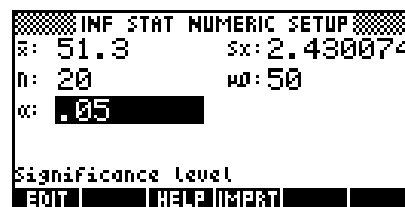

If you now change to the **NUM** view you will see the inferential data in numeric form. The test Student-t value is given as 2.392 and the probability of obtaining such a value as 0.0272. The critical t values for this test level of 5% are given as  $\pm 2.093$  and the critical boundaries for the sample mean as 48.86 and 51.14.

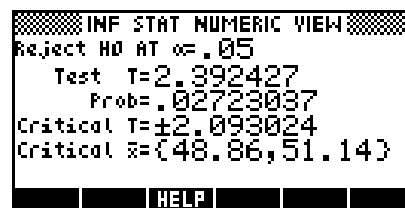

Sample t value is outside rejection

The same information can be seen in a more visual form if you change to the **PLOT** view. The upper diagram shows the critical range for the t values, while the lower horizontal line shows the equivalent critical sample mean range.

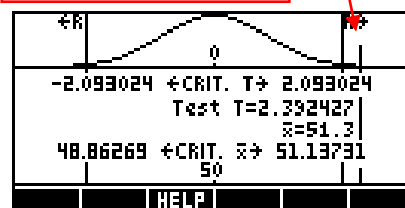



The test value for the Student-t and the sample mean are listed in the middle of the screen and the rough position of these values is shown by a vertical line in both the upper and lower diagrams. The regions for rejection of the null hypotheses are shown at the very top of the screen by the ' $\leftarrow R$ ' and ' $R \rightarrow$ '.

We assume, by statistical theory, that the distance  $(\bar{x} - \mu)$  is normally distributed. If the null hypothesis is true then the mean of this new distribution should be zero. Our result is indicating that our particular value of  $(\bar{x} - \mu)$  is of such a size that if the null hypothesis is true then the probability of it appearing by chance is less than 5%.

In this case, whether you work from the **PLOT** view or the **NUM** view, it is clear from the evidence that the null hypothesis should be rejected, with less than a 5% chance of this rejection being incorrect. The alternate hypothesis that the mean is not 50 should be accepted. Of course in this case, despite some boxes containing less than 50 matches, the actual mean seems to be above 50 so we can hardly condemn the company for putting more matches in the boxes than they need to!

### Confidence interval: T-Int $1-\mu$

In the previous example we found that the evidence of our sample indicated that the mean number of matches in the boxes was not 50. Suppose we now want to know, at the 95% confidence level, within what range of values the true population mean lies.

Change back to the **SYMB** view and **CHODS** the method of *Conf Interval*. The type of interval is converted to the similar type of *T-INT: 1  $\mu$* .



In the **NUM SETUP** view use the import facility as before to import the values from our sample data. The default confidence level is 99% so you will need to change that to 0.95.

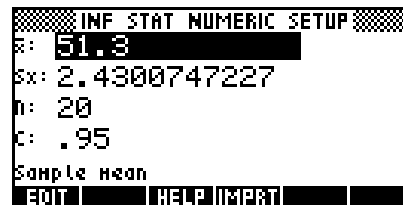

Changing to the **NUM** view gives the minimum and maximum values for the population mean of 50.16 to 52.44 at a 95% confidence level.

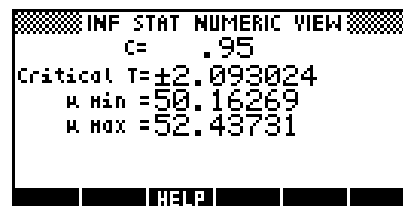

As before, a more visual display can be seen in the PLOT view.

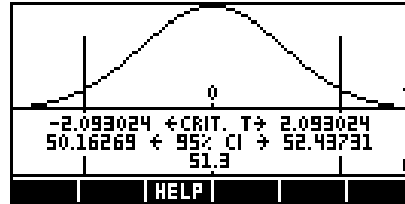

Thus the sample data indicates in our two examples that:

- we can be confident the average number of matches is not 50 with less than a 5% chance of being wrong, and
- we can conclude, with a confidence of 95%, that the true average number of matches is between 50.16 and 52.44.

### Hypothesis test: T-Test $\mu_1 - \mu_2$

A farmer compared the 15-day mean weight of two sets of chicks, one group receiving feed supplement A and the other supplement C. Twenty two chicks only one day old were assigned randomly to the two groups. To distinguish between the two groups of eleven, which were caged together to minimize other influences, the heads of the chicks were stained red and purple respectively with a harmless vegetable dye. The individual weights were recorded in the table to the right. From the means at the bottom of the table it appears that supplement A produces a higher mean weight. The farmer wishes to know, at the 1% test level, whether this is statistically significant.

Weights	
Supplement A	Supplement C
57	89
120	30
101	82
137	50
119	39
117	22
104	57
73	32
53	96
68	31
118	88
$\bar{x} = 97$	$\bar{x} = 56$
$\sigma_x = 27.75$	$\sigma_x = 26.54$

Our hypotheses are:

$H_0$ : The effects are the same ( $\mu_1 = \mu_2$ )

$H_A$ : Supplement A is better ( $\mu_1 > \mu_2$ )

Enter the data into columns C1 and C2 of the Statistics applet.

n	C1	C2	C3	C4
1	57	89		
2	120	30		
3	101	82		
4	137	50		
5	119	39		
6	117	22		
7	104	57		
8	73	32		
9	53	96		
10	68	31		
11	118	88		
12				
13				
14				
15				
16				
17				
18				
19				
20				
21				
22				
23				
24				
25				
26				
27				
28				
29				
30				
31				
32				
33				
34				
35				
36				
37				
38				
39				
40				
41				
42				
43				
44				
45				
46				
47				
48				
49				
50				
51				
52				
53				
54				
55				
56				
57				
58				
59				
60				
61				
62				
63				
64				
65				
66				
67				
68				
69				
70				
71				
72				
73				
74				
75				
76				
77				
78				
79				
80				
81				
82				
83				
84				
85				
86				
87				
88				
89				
90				
91				
92				
93				
94				
95				
96				
97				
98				
99				
100				

We are dealing with two independent samples in this case and so we need to choose from those tests which involve two samples.

```

INF STAT SYMBOLIC VIEW
METHOD: HYPOTH TEST
TYPE: T-Test:  $\mu_1 - \mu_2$ 
ALT HYPOTH:  $\mu_1 > \mu_2$ 
Choose an inferential method
|CHOOSE|
  
```

Since we know the standard deviations of only these samples, we must again use a Student-t test. We then change to the **NUM SETUP** view to import the summary statistics.

```

IMPORT SAMPLE STATS
x1: 97      x2: 56
n1: 11     n2: 11
sx1: 29.10670  sx2: 27.83522
COLUMN: C1  COLUMN: C2
Stat import data column
|CHOOSE| |CANCEL| |OK|
  
```

Since the two standard deviations for the samples are similar, and the sample sizes are the same, a more accurate estimate of the population standard deviation will be obtained if the data is pooled, so ensure that this option is **CHKed**.

```

INF STAT NUMERIC SETUP
x1: 97      x2: 56
s1: 29.10670  s2: 27.83522
n1: 11     n2: 11
 $\alpha$ : .01    Pooled?
"Pooled" if checked
|EDIT| CHK|HELP|IMPRT|
  
```

The **NUM** view shows the critical values. We can see that the probability of obtaining a test student-t value of 3.38 is 0.0015 and this is well below the permitted test level of 1%.

```

INF STAT NUMERIC VIEW
Reject H0 AT  $\alpha = .01$ 
Test T = 3.376407
Prob = .001500072
Critical T = 2.527977
|HELP|
  
```

The **PLOT** view also shows that the vertical line representing the value of  $\bar{x}_1 - \bar{x}_2$  or  $\Delta\bar{x}$  is well into the region of rejection indicated by the  $R \rightarrow$ .



From the evidence we should reject the null hypothesis and accept instead that the average weight of the group receiving supplement A is significantly higher than those receiving supplement C with only a 1% chance of being incorrect.

### Hypothesis test: Z-Test $1-\mu$

A teacher has developed a new teaching technique for hearing-impaired students which he believes is producing significantly better results. He wishes to publish a paper on this and needs to check his results statistically.

A standardized test is available for which it is known that the normal performance of hearing-impaired students at the same stage of study has a mean of 53.6% and a standard deviation of 12.2%. When he applies this test to his class of 23 students their scores are shown below. The teacher believes that this data shows that his students are scoring significantly better and wishes to test this at a level of 5%.

Test results:

{57, 72, 42, 50, 55, 58, 59, 38, 45, 53, 77, 57, 52, 69, 50, 55, 59, 68, 62, 63, 53, 56}

Enter the data into column **C1** of the Statistics applet.

Changing to the Inference applet, we choose a Hypothesis test using *Z-test:  $1 \mu$* , since we know the population standard deviation.

The hypotheses are:

$H_0$ : The sample is drawn from a population whose mean is the same as the standardized population ( $\mu = \mu_0$ ).

$H_A$ : The sample is drawn from a population whose mean is larger than that of the standardized population ( $\mu > \mu_0$ ).

n	C1	C2	C3	C4
1	57			
2	72			
3	42			
4	50			
5	55			
6	58			
7	57			

57

INF STAT SYMBOLIC VIEW

METHOD: HYPOTH TEST

TYPE: Z-Test:  $1 \mu$

ALT HYPOTH:  $\mu > \mu_0$

Choose an inferential method

CHOOSE

Change to the NUM SETUP view, you can use the import facility to import the summary statistics from the Statistics applet.

INF STAT NUMERIC SETUP	
$\bar{x}$ :	IMPORT FROM...
$\mu_0$ :	Statistics
$\alpha$ :	Related sets
	Coin Tossing
Sample mean	
	CANCEL OK
IMPORT SAMPLE STATS	
$\bar{x}$ :	56.81818
n:	22
COLUMN:	C1
Stat import data column	
	CHOOSE CANCEL OK

Enter the values for the mean and standard deviation of the standardized test, and the significance level of 0.05 (5%).

If we now change to the **NUM** view we can see that the test z score is less than the required critical z\*, and the probability of obtaining a mean of the value found is 0.1080, which is larger than the required test value of 0.05.

In the **PLOT** view, we can see visually that the vertical line representing the sample mean is not within the region of rejection marked by the  $R \rightarrow$ .

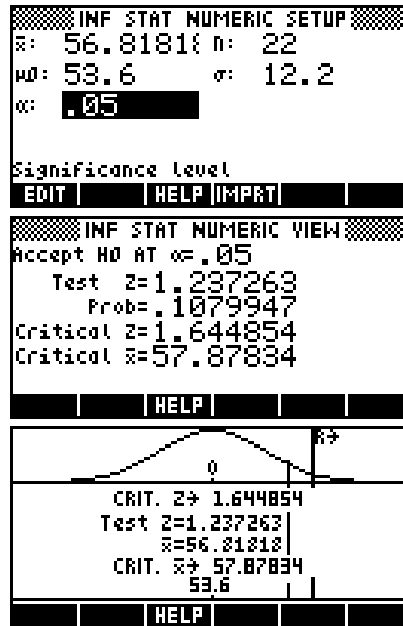

From the evidence the teacher must reject the alternate hypothesis and conclude that it is not possible to say at the 5% level of significance that his class has averaged significantly higher than the standardized population from which the test was drawn. He should re-think his proposed paper or his new teaching method. Alternatively, from the diagram in the **PLOT** view it seems that his mean is not far from being significant. Perhaps he simply needs to collect more data in the hopes that this may back up his view. The result he has obtained is, after all, only a probability and further investigation may give a different view.

## TIPS & TRICKS - INFERENCE

### Importing from a frequency table

The import (**IMPORT**) facility of the Inference applet has a small weakness in that it can't import from paired columns defining a frequency table.

For example, suppose we use columns **C1** and **C2** to define a frequency table, ensuring that it is registered in the **SYMB** view as shown right.

n	C1	C2	C3	C4
1	10	5		
11		12		
12		26		
13		18		
14		5		

EDIT   INS   SORT   BIG   IVAR   STATS				
NEW STATISTICS SYMBOLIC VIEW				
✓H1:	C1	C2		
H2:		1		
1-VAR	H1			
ME	66			
TOTΣ	748			
MEANΣ	12.09091			
SVARΣ	1.052342			
SYVARΣ	1.068531			
PSDEV	1.025837			
ΣΣ				
				OK

If you now change to the **NUM SETUP** view of the Inference applet and try to use the import facility you will find that you can import the mean and standard deviation from either column **C1** or **C2** but not from both at once.

What's needed, of course, is a way to expand the paired frequency table columns into a single column listing all values. The program shown below will do this for you. It is set up to take a frequency table defined in columns **C8** and **C9** and convert them into a single column stored in column **C0**. The program uses columns 8, 9 & 10 because there is seldom data in them.

To create it, go to the **Program Catalog** view and press the **NEW** key. Enter any name you want, such as 'CCreate'. Now type in the code below.

```

CCREATE PROGRAM
MAKELIST(0,X,1,ΣLIST(C9),1)▶C0:
1▶Z:ERASE:
FOR I=1 TO SIZE(C9);
  FOR J=1 TO C9(I);
    C8(I)▶C0(Z):
    DISP 7;Z:
    Z+1▶Z:
  END:
END:
END:
STOP | SPACE | ▲ PAGE | A...Z | BKSP
  
```

We'll now use this program to expand the frequency table I built earlier. The first thing we need to do is to move columns **C1** and **C2** to **C8** and **C9**. Rather than re-typing, this can be done in the **HOME** view as shown.

NEW STATISTICS	
C1▶C8	{10,11,12,13,14}
C2▶C9	{5,12,26,18,5}
STOP	

Now change into the **Program Catalogue** and **RUN** the program you created. Assuming that it has no errors you will see a running count as it creates the new column. This is just to give you something to watch while it works.

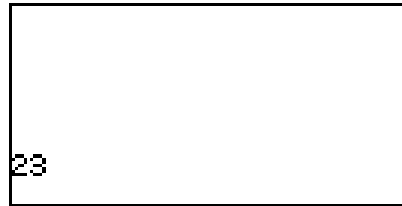

If you then change to the **NUM** view you will find that column **C0** contains the result.

n	C7	C8	C9	C0
1		10	5	10
2		11	12	10
3		12	26	10
4		13	6	10
5		14	18	10
6			5	10
7				11
8				
9				
10				
11				
12				
13				
14				
15				
16				
17				
18				
19				
20				
21				
22				
23				
24				
25				
26				
27				
28				
29				
30				
31				
32				
33				
34				
35				
36				
37				
38				
39				
40				
41				
42				
43				
44				
45				
46				
47				
48				
49				
50				
51				
52				
53				
54				
55				
56				
57				
58				
59				
60				
61				
62				
63				
64				
65				
66				
67				
68				
69				
70				
71				
72				
73				
74				
75				
76				
77				
78				
79				
80				
81				
82				
83				
84				
85				
86				
87				
88				
89				
90				
91				
92				
93				
94				
95				
96				
97				
98				
99				
100				

You can now import that column's mean and standard deviation into the Inference applet. After you have used the column you will probably also want to delete columns **C8**, **C9** and **C0** to save space.

Bear in mind that if you use this program to create a column containing hundreds or even thousands of values then the program will take a *long* time to complete. It might be easier to use the Statistics applet to calculate the required mean and standard deviation in the normal way and then enter the values into the Inference applet either by hand or by using the **VARS** menu.

## THE FINANCE APLET

This applet is designed to allow users to solve time-value-of-money (TVM) and amortization style problems quickly and easily, as well as ordinary compound interest problems.

Compound interest problems involve bank accounts, mortgages and similar situations where “money earns money”. TVM problems involve the use of the idea that the value of money changes with time - a dollar today is worth more than the same dollar some years from now. For example, that a dollar invested today can generate more money than the same dollar invested later.

The calculator manual contains a lengthier explanation for those who need it, as does any high school or college textbook.

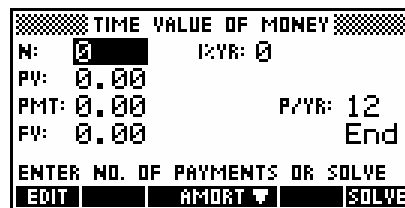

When you **START** the applet you will see the initial view shown right.

Pressing **SYMB**, **NUM** or **PLOT** will make no difference to this applet as it is quite limited and only has the one view, consisting of two related pages.

### Parameters

There are a number of parameters or variables which must be either supplied or solved for. These are:

- N** - The total number of compounding payments or payments.
- Mode** - This has the value of **Beg**(inning) or **End** depending on when payments occur relative to the compounding periods - at the beginning or the end.
- P/YR** - The number of payments per year.
- I%YR** - The nominal interest rate or investment rate per year. This is then divided by **P/YR** to find the nominal interest per compounding period. This is the rate actually used in the internal calculations.



- PV** - This is the present value of the initial flow of cash. In a loan, this is the amount of the loan. In an investment, the amount invested. **PV** is always the amount at the start of the first period, however long that may be.
  
- PMT** - This is the size of the periodic payment. The assumptions made are that all payments are the same size and that no payments will be skipped. Payments can occur at the beginning or the end of a compounding period, depending on the setting of **Mode**.
  
- FV** - The future value of the investment or loan. This could be the amount in a bank account after a period of years, the residual on a lease, the amount still owing on a loan after **N** repayments, or the remaining value of an investment which has been paying income as an annuity.

When using the aplet is it important to visualize the cash flow in terms of positive cash (inwards) or negative cash (outwards). This can be illustrated simply via the following example. Always bear this principle in mind when deciding how to plan your setup of the aplet.

### ***Straightforward compound interest***

*Invest \$1000 into a bank account paying 6.5% per annum for 5 years. Interest is calculated monthly and credited to the account at the end of each month. What is the investment worth at the end of the period?*

Looked at from the point of view of the person investing the money, the cash flow is initially outwards (negative) by \$1000. The final payment is inwards (positive) and no payments (withdrawals) are made during the period of the investment. Five years of monthly payments means that **N** is 60. The view on the right shows the problem on the calculator. The **SOLVE** button has been pressed to give a future value **FV** of \$1816.70.

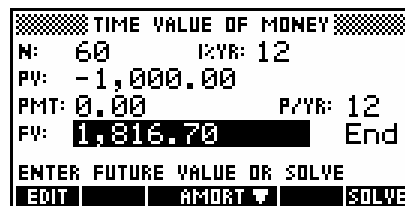

#### **Calculator Tip**

As can be seen above, the designers of this aplet chose to display money to 2 decimal places and using comma separators. This choice is independent of the settings in the **MODES** view. When entering values do not use commas as they will simply result in a syntax error.

## Annuity

An engineer retires with \$650,000 available for investment. She invests the money in a portfolio which is expected to have an average return of 5% per annum. She wants to have the account pay a monthly income to her and asks the accountant to assume that the income must last for 20 years. What income can be withdrawn?

The **PV** for this problem is negative because, from the point of view of the engineer, the money flow is outward from her to the investment portfolio. The value of the regular payment, which has been solved for on the right, is positive as it is being paid from the portfolio to her. We also assume that the future value **FV** is to be zero since the income is only to last for 20 years. On this basis the monthly annuity can be \$4289.71

TIME VALUE OF MONEY			
N:	240	I/YR:	5
PV:	-650,000.00		
PMT:	4,289.71	P/YR:	12
FV:	0.00		End
ENTER PAYMENT AMOUNT OR SOLVE			
EXIT		AMORT	SOLVE

## Loan calculations

You wish to purchase a car by taking out a loan. The current interest rate is 6.5% and you can afford to make monthly payments of \$300. You want to take out the loan over a period of 6 years and to still owe \$10,000 at the end of that period (you expect an investment to mature at that time to pay the final amount). How much can you borrow?

In this case, from your point of view, the payments and the **FV** final residual are outgoing (negative) since they are made to the bank. We have pressed **SOLVE** to find the **PV** and this is the amount that can be borrowed. It will be positive since it is paid to you. In this case it is clear that you can afford to borrow \$24,624.29.

TIME VALUE OF MONEY			
N:	72	I/YR:	6.5
PV:	24,624.29		
PMT:	-300.00	P/YR:	12
FV:	-10,000.00		End
ENTER PRESENT VALUE OR SOLVE			
EXIT		AMORT	SOLVE

## Amortization

The second page of this applet allows amortization calculations in order to determine the amounts applied towards the principal and interest in a payment or series of payments.

Suppose we borrow \$20,000 at an interest rate of 6.5% and make monthly payments of \$300. The initial situation is as shown in the screen on the right.

```

TIME VALUE OF MONEY
N: 0          I/YR: 6.5
PV: 20,000.00
PMT: -300.00  P/YR: 12
FV: 0.00      End
ENTER NO. OF PAYMENTS PER YEAR
EDIT  AMORT  T
    
```

Press the **AMORT** button to change to the amortization screen. The initial appearance is as shown. As can be seen, the default number of payments to amortize over is 12.

```

AMORTIZE
PAYMENTS: 12
PRINCIPAL:
INTEREST:
BALANCE:
ENTER NO. OF PAYMENTS TO AMORT
EDIT  TUM  B→PV  AMOR
    
```

Pressing the **AMOR** button will amortized the loan over the first year. As can be seen right, \$2,369.77 has been paid off the principal, leaving a balance of \$17,630.23. Of the payments made, \$1,230.23 went towards the payment of interest.

```

AMORTIZE
PAYMENTS: 12
PRINCIPAL: -2,369.77
INTEREST: -1,230.23
BALANCE: 17,630.23
ENTER NO. OF PAYMENTS TO AMORT
EDIT  TUM  B→PV  AMOR
    
```

Pressing the **B→PV** button will transfer the balance back to the previous page as the new value of the **PV**.

```

TIME VALUE OF MONEY
N: 0          I/YR: 6.5
PV: 17,630.23
PMT: -300.00  P/YR: 12
FV: 0.00      End
ENTER NO. OF PAYMENTS OR SOLVE
EDIT  AMORT  T  SOLVE
    
```

At this stage you can amortize again for another 12 months as shown right. This can be continued indefinitely.

```

AMORTIZE
PAYMENTS: 12
PRINCIPAL: -2,528.48
INTEREST: -1,071.52
BALANCE: 15,101.75
ENTER NO. OF PAYMENTS TO AMORT
EDIT  TUM  B→PV  AMOR
    
```

## THE QUAD EXPLORER TEACHING APLET

Rather than being a multi-purpose applet, this is a teaching applet specialized to the single use of exploring graphs of quadratics.

### Objectives

Using the Quadratic Explorer applet, the student will investigate the behavior of the graph of  $y = a(x+h)^2 + v$  as the values of  $a$ ,  $h$  and  $v$  change. This can be done both by manipulating the equation and seeing the change in the graph, *and* by manipulating the graph and seeing the change in the equation.

Press **START** to see the main screen of the applet, shown right. This applet has only the one screen, rather than the usual **PLOT**, **SYMB** and **NUM** views. If the applet has been used before then it may be necessary to press the **RESET** screen key to go back to the opening view.

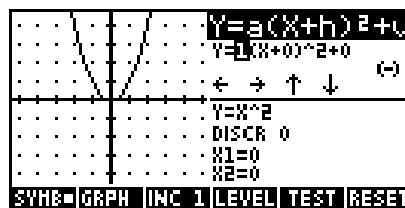

The first choice made by the user should be the **LEVEL**. The default level is that of  $Y=a(X+h)^2+v$ , which allows the student to change all parameters at once. By having the student choose the levels of  $Y=aX^2$ ,  $Y=(x+h)^2$  or  $Y=X^2+v$ , the teacher can confine the study to the effects of only one coefficient at a time if desired.

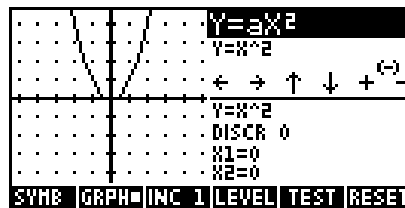

The default state for the applet is to be in **GRAPH** mode. In this mode the student uses the keys listed below to control the appearance of the graph, with these changes reflected automatically in the two equations on the right half of the screen. The original  $y=x^2$  graph is kept on the screen (dotted) for comparison and a grid is supplied to allow the user to see movement more clearly.

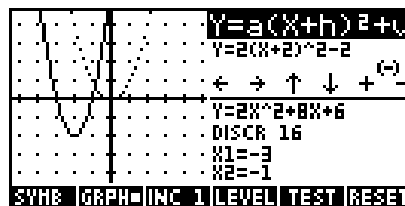

The control keys (listed onscreen) are:

- ↑ ↓ → ←      moves the graph in the obvious way.
- + and -                  cycles the value of 'a' in  $y=a(x+h)^2+v$  through the values 0.1, 0.2, 0.3, 0.5, 1, 2 & 5.
- (-)                  (the 'negative' key) changes the sign on the 'a' coefficient turning the graph upside down.

As can be seen in the screen shots right, the bottom half of the screen shows the roots (if any), the value of the discriminant and the equation in the form  $y=ax^2+bx+c$ .

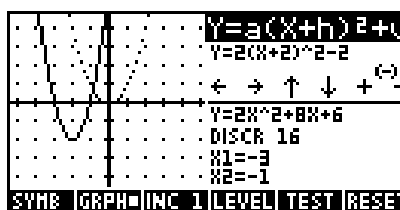

The key labeled **INC 1** changes the 'step size' of the movements on the screen. Possible values for the increment are 0.5, 1 and 2.

Pressing **SYMB** on the calculator, or the screen key labeled **SYMB** will change the emphasis from the graph to the equation in the right hand half of the screen. Pressing **PLOT** on the calculator, or the key labeled **GRAPH** will change the emphasis from the equation back to the graph.

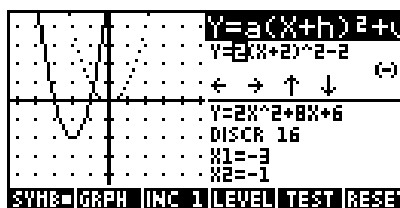

In **SYMB** mode the student can change the coefficients directly and see the changes reflected in the graph.

For example, on the screen shown below, the 'v' coefficient is highlighted and can be changed using the  $\uparrow$  and  $\downarrow$  keys. The size of the changes to 'h' and 'v' is controlled by the **INC 1** key, and the same range of values is available for the values of 'a' as in **GRAPH** mode. You can move from one coefficient to the next by using the  $\rightarrow$  and  $\leftarrow$  keys.

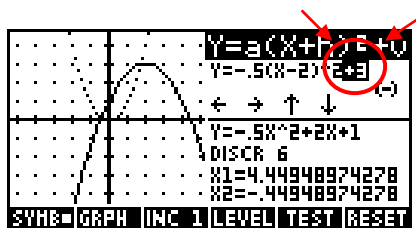

As with the **GRAPH** mode, the equation in  $y=ax^2+bx+c$  form, its roots and its discriminant are shown on the right half of the screen.

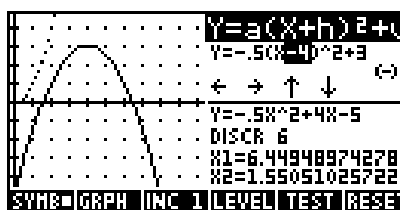

The sequence of three screen shots right show how the axes automatically re-position to allow a larger range of values to be explored. There is a limit to how far the graph can move.

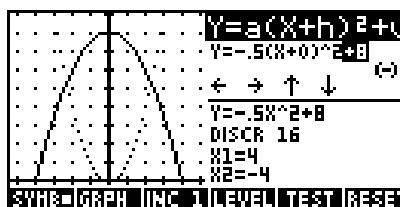

The + and - keys are disabled in **SYN3** mode, since their effects are controlled instead by the  $\uparrow$  and  $\downarrow$  keys once the highlight is on the 'a' coefficient. The (-) key controls the sign of 'a'.

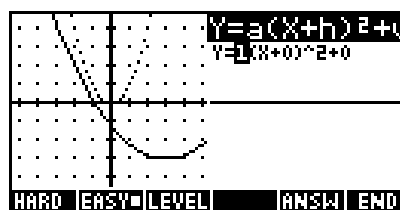

The final key is labeled **TEST**. This key will present the student with a series of graphs for which they must supply the equation. The type of graph is governed by the current setting of **LEVEL**. For example, if the current setting of **LEVEL** was at  $Y = X^2 + v$  then the test graphs would also only use the  $v$  parameter instead of  $a$ ,  $h$  and  $v$  simultaneously. The setting of **LEVEL** can be changed within the **TEST** screen using the key supplied.

There are two levels of 'questions' denoted by the keys **EASY** and **HARD** on the screen. An **EASY** question will be in the main screen (-5 to 5 on each axis), whereas a **HARD** one can be anywhere in the larger screen (see right). The setting of **LEVEL** also affects the difficulty of the question. The first is always **EASY** but you can substitute another by pressing **EASY** or **HARD**.

In **TEST** mode you must use the arrow keys to change the parameters 'a', 'h' and 'v' until they match the graph shown. The accuracy of your answer can be checked by pressing the key labeled **CHECK**, which appears as soon as you begin to change the values. The number of attempts is monitored and displayed.

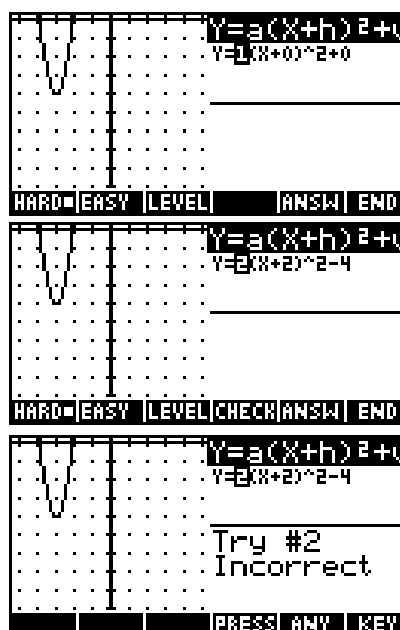

An incorrect answer is shown as an 'animated' graph on the screen when you press **CHECK**, flashing repeatedly between the required graph and your incorrect guess. This has to be seen to be appreciated - a screen shot can't do it justice. If your guess and the required graph can't be shown on the same screen then this animation may not be possible. If you are unable to find the answer, pressing **ANSW** will display the correct parameters.

When you are successful, or when you give up, press either **EASY** or **HARD** for a new graph, or **END** to return to the main screen.

If you go to HP's website you can download a worksheet for use with your class. It takes the student through the process of deducing the effects of each of the coefficients on the shape of the graph, requiring them to record their answers in writing.

## THE TRIG EXPLORER TEACHING APLET

Rather than being a multi-purpose applet like most of the others covered so far, this is a teaching applet specialized to the single use of exploring the graphs of trigonometric functions.

### Objectives

Using the Trig Explorer applet, the student will investigate the behaviour of the graph of  $y = a \sin(bx + c) + d$  as the values of  $a$ ,  $b$ ,  $c$  and  $d$  change. This can be done both by manipulating the equation and seeing the change in the graph, or by manipulating the graph and seeing the change in the equation.

When the student presses **START**, they will see the main screen of the applet, shown right. Like the Quadratic Explorer, this applet has only one screen, rather than the usual **PLOT**, **SYMB** and **NUM** views. If the applet has been used before then it may be necessary to press the **RESET** screen key to go back to the opening view shown.

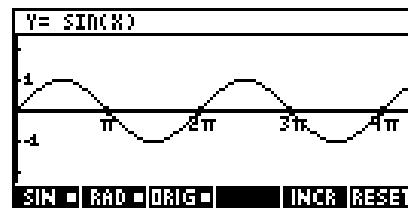

The **SIN** (or **COS**) key can be used to toggle between the  $y = \sin(x)$  curve and the  $y = \cos(x)$  curve. The **RAD** (or **DEG**) key can be used to toggle between radian measure and degree measure. The markings on the horizontal axis adjust accordingly (see right).

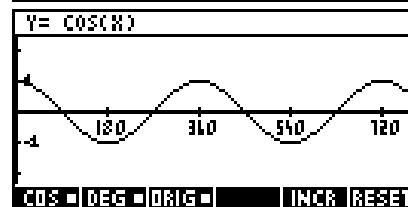
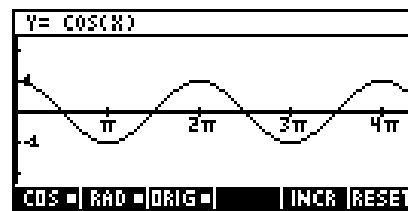

The Trig Explorer applet can be used in two modes:

- SYMB** mode - the equation controls the graph (press the **SYMB** key).
- and **PLOT** mode - the graph controls the equation (press the **PLOT** key).

Which mode is in operation is controlled by pressing the **SYMB** and the **PLOT** keys. The **NUM** key has no effect in this applet and the applet has no **SETUP** views. The ranges for the x and y axes are preset and cannot be changed.

In both modes the original shape of the sine or cosine graph is left visible as a dotted line for comparison.

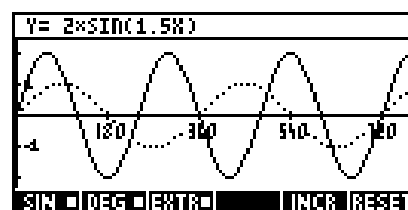

The operation of the two modes is summarized below.

### **PLOT mode**

The underlying concept in **PLOT** mode is that the graph controls the equation.

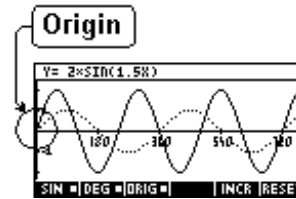

The user has control of the graph via two manipulation points (see above and below) and any changes to the graph are reflected in the equation at the top of the screen.

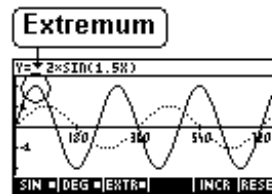

Looking at the screens on the right it will be seen that the third screen key toggles the point of control for the graph. It is only visible in **PLOT** mode.

When in **PLOT** mode the graph is changed using the arrow keys. The effects of the arrow keys vary according to the location of the control point.

- when control is set to **ORIG** the graph translates left and right (the  $c$  coefficient) or up & down (the  $d$  coefficient).
- when control is set to **EXTR** the graph dilates parallel to the  $y$  axis (the  $a$  coefficient) or parallel to the  $x$  axis (the  $b$  coefficient).

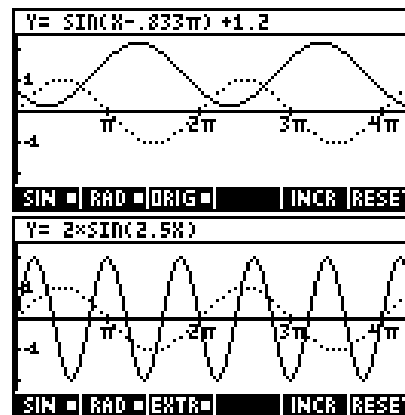

Unlike the **SYMB** mode where the  $b$  coefficient goes up or down in steps of 0.1, the increments in **PLOT** mode are not regular but are chosen to be 'nice' fractions of  $\pi$ . The slight difference in results is most easily seen by simply experimenting.

### **SYMB mode**

The underlying concept in **SYMB** mode is that the equation controls the graph. The user has control of the coefficients and any changes are reflected in the graph.

All four coefficients are shown at the top of the screen even when one or more is redundant.

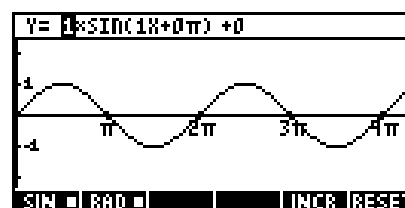



The  $c$  coefficient is shown as a multiple of  $\pi$  in radian mode rather than as a decimal. The currently active coefficient is highlighted and can be changed using the up/down arrow keys in increments of 0.1 for the coefficients  $a$ ,  $b$  and  $d$ .

The default increment for  $c$  is  $\pi/6$  but this can be changed using the key labeled **INCR** to either  $\pi/9$  or  $\pi/4$ .

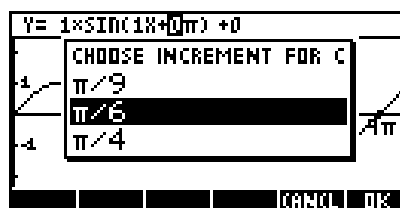

When in **DEG** mode, the increments are  $20^\circ$ ,  $30^\circ$  or  $45^\circ$  with  $30^\circ$  being the default.

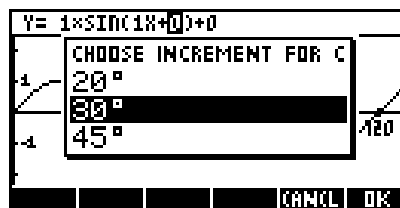

The ranges of values available for the four coefficients are shown below:

Coeff.	Range
$a$	-3 to 3
$b$	0.2 to 5
$c$	$-4\pi$ to $4\pi$
$d$	-3 to 3

If you go to HP's website you can download a worksheet for use with your class. It takes the student through the process of deducing the effects of each of the coefficients on the shape of the graph, requiring them to record their answers in writing.



If you look at the list of screen keys on the bottom of the view, you will see one labeled **GO→**. This determines which way the highlight will move (across or down) when you enter a number. If you press the key repeatedly you will see it change from **GO→** (across), to **GO↓** (down), to **GO** (no movement).

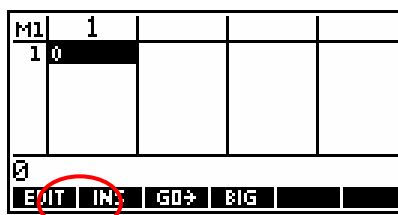

You will also see the usual **BIG** key, and an **INS** key that can be used to insert an extra row or column into an existing matrix. The keyboard **DEL** key can be used to delete a row or column.



With movement set to **GO→**, type in the numbers 1, 2 and 3, pressing **ENTER** after each. Your display should now look like the screen shot right.



If you now press the down arrow key on the keyboard the highlight will move back to the first element in the second row. Enter the numbers 4, 5 and 6 and you will find that the calculator automatically drops down to row three without the need to use the down arrow key again, since it now knows how many columns the matrix is to contain. Finish your matrix so that it looks like the one shown right.

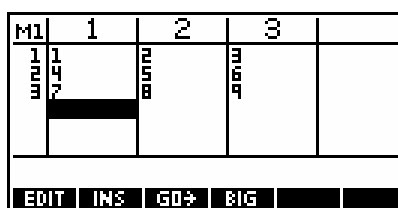

Now press **MATRIX** to switch back to the **MATRIX Catalog** and, with the highlight on **M2**, press **EDIT** and create the matrix shown right.

$$\begin{bmatrix} 2 & -1 \\ 3 & 4 \\ -1 & 7 \end{bmatrix}$$

Switch to the **HOME** view and multiply **M1\*M2**. As you can see, the result displayed in the **HOME** view is not very useful or readable. Pressing **SHOW** displays the matrix in a far more readable manner.

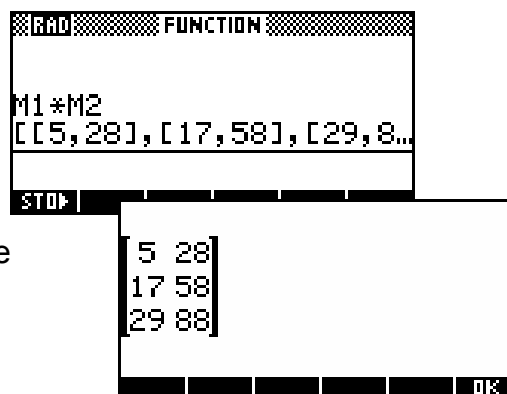

Another method is to store the result into a third matrix and then to view it through the Edit screen of the **MATRIX Catalog**. This is shown below.

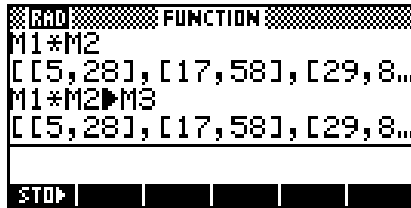

Matrix **M3** is created left and edited right.

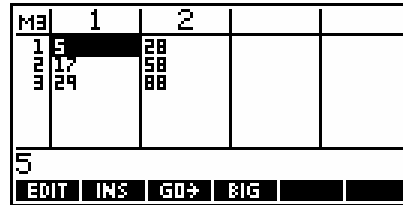

Probably the most common functions that you will use are **INVERSE**, **DET** and **TRN** (transpose), so some worked examples are included which use them. There are also a number of further worked examples involving matrices in the section at the back of the book.

Eg. 1 Solve the system of equations:

$$\begin{cases} 2x + 3y - z = -6 \\ x - 3y + z = 12 \\ 3x - y + 4z = 13 \end{cases}$$

Solution: The system of equations can be represented as the system of matrices:

$$\begin{bmatrix} 2 & 3 & -1 \\ 1 & -3 & 1 \\ 3 & -1 & 4 \end{bmatrix} \begin{bmatrix} x \\ y \\ z \end{bmatrix} = \begin{bmatrix} -6 \\ 12 \\ 13 \end{bmatrix}$$

this system can be algebraically rearranged to:

$$\begin{bmatrix} x \\ y \\ z \end{bmatrix} = \begin{bmatrix} 2 & 3 & -1 \\ 1 & -3 & 1 \\ 3 & -1 & 4 \end{bmatrix}^{-1} \begin{bmatrix} -6 \\ 12 \\ 13 \end{bmatrix}$$

where the inverse matrix is...

$$\begin{bmatrix} 2 & 3 & -1 \\ 1 & -3 & 1 \\ 3 & -1 & 4 \end{bmatrix}^{-1}$$

which gives a final answer of

$$\begin{bmatrix} x \\ y \\ z \end{bmatrix} = \begin{bmatrix} 2 \\ -3 \\ 1 \end{bmatrix}$$

Mathematically what we have done is:

$Ax = b$  where **A** is the coeff. matrix  
and **b** is the constant matrix.

$$x = \frac{1}{A} \times b$$

which is usually written as:  $x = A^{-1} \times b$

or as:  $x = \text{inverse}(A) \times b$

The method for doing this on the hp 39g+ is as follows...

Step 1. Enter the **MATRIX Catalogue**. Use **SHIFT CLEAR** to erase all matrices.



Step 2. Enter the 3x3 matrix of coefficients in **M1**.

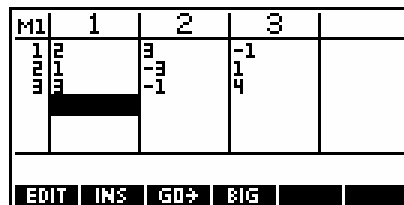

Step 3. Enter the 3x1 matrix of into **M2**. Note the change to **GO↓** in order to make entering numbers easier.

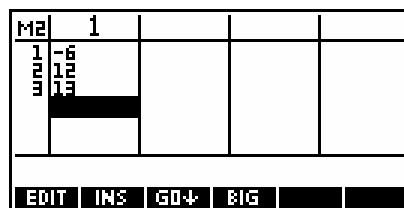

Step 4. Change to the **HOME** view, evaluate  $A^{-1} \times b$  using any of the following three methods (all of which are acceptable to the hp 39g+), and store the result into **M3**.

- (a)  $M1^{-1} * M2$
- (b)  $M2 / M1$
- (c)  $INVERSE(M1) * M2$



The best of these is probably (a) because it doesn't involve fetching the **INVERSE** function from the **MATH** menu and, unlike (b), reminds you that the operation is really left-multiplication by the inverse rather than division, an operation which is not strictly speaking defined for matrices but is allowed for convenience on the hp 39g+.

The answer displayed is  $[[2], [-3], [.999999999999]]$ . This is really the same as  $x = 2, y = -3, z = 1$ . The strange answer for  $z = 1$  is caused by internal precision errors. You are expected to realize yourself that it should be  $z = 1$ .

Eg. 2 Find the inverse matrix  $A^{-1}$  for the matrix  $A = \begin{bmatrix} 2 & 1 & 4 \\ 1 & 1 & 3 \\ -2 & 4 & -1 \end{bmatrix}$

The first step is to store the matrix A into **M1**. If you now simply store its inverse into **M2** you will find, depending on the determinant, that the result is probably a collection of decimal values (see right).



While correct, this is hardly the best way to display the answer. The fact that the determinant is incorporated into the inverse makes whole numbers unlikely.

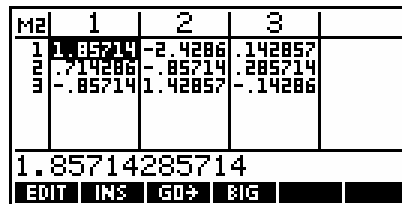

A better way is often to write the answer as a fraction  $\frac{1}{\det(A)}$  multiplied by a matrix of whole numbers. If we multiply the inverse by the determinant then we can usually remove the fractions.

i.e.

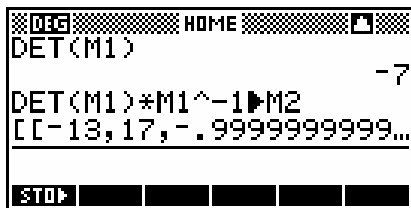

with M2 being...

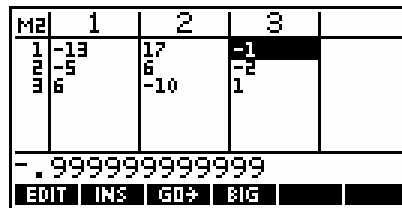

Thus we can finally write:  $A^{-1} = \frac{1}{-7} \begin{bmatrix} -13 & 17 & -1 \\ -5 & 6 & -2 \\ 6 & -10 & 1 \end{bmatrix}$

An alternative to this is to change into *Fraction* 6 numeric format in the **MODES** view. This will give a matrix of fractional values which can be seen more clearly using **SHOW**.



Fig. 4 Find the angle between the vectors  $a = (3,4)$  and  $b = (4,1)$  .

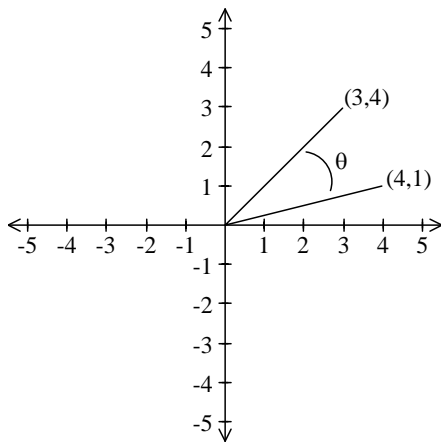

Using the formula that

$$\underline{a} \bullet \underline{b} = |\underline{a}| \cdot |\underline{b}| \cdot \cos \theta$$

where  $\underline{a} \bullet \underline{b}$  is the dot product, we can rearrange to obtain:

$$\cos \theta = \frac{\underline{a} \bullet \underline{b}}{|\underline{a}| \cdot |\underline{b}|}$$

$$\begin{aligned} \cos \theta &= \frac{(3,4) \bullet (4,1)}{|(3,4)| \cdot |(4,1)|} \\ &= \frac{3 \times 4 + 4 \times 1}{\sqrt{3^2 + 4^2} \cdot \sqrt{4^2 + 1^2}} \end{aligned}$$

Therefore:

$$\begin{aligned} &= \frac{16}{5\sqrt{17}} \\ \theta &= 39.09^\circ \end{aligned}$$

On the calculator, the functions DOT and ABS give the dot product and magnitude respectively, *when fed with vectors*. The hp 39g+ writes vectors as row matrices. For example  $a = (3,4)$  would be written as  $[3, 4]$ .

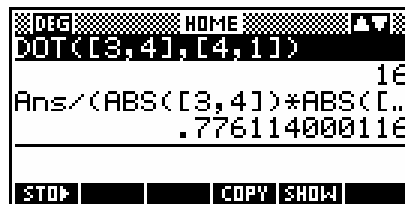

The calculations are shown in the two screen shots on the right. Remember to change into degree mode first.

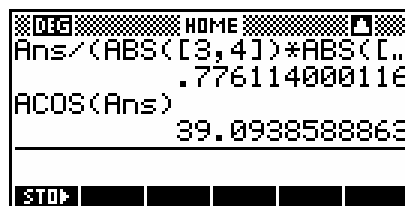

The list of matrix functions available through the **MATH** menu is covered starting on page 271. Not all functions are covered, since many of them go far beyond the requirements of the average student at whom this book is aimed.

## USING LISTS ON THE HP 39G+

A list in the hp 39g+ is the same mathematically as a set. As with a set, it is written as numbers separated by commas and enclosed with curly brackets.

Eg.  $\{2, 5, -2, 10, 3.75\}$

Using the **HOME** view these lists can be stored in special list variables. There are ten of these L1, L2, . . . L9, L0.

Eg.  $\{2, 5, -2, 10, 3.75\} \rightarrow L1$

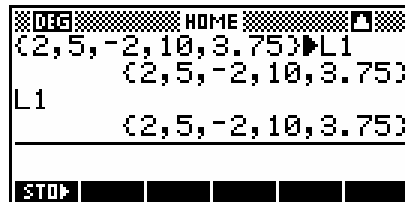

Typing **L1** and then **ENTER** will then retrieve the list. Lists can also be multiplied by a constant and have a constant added to them (see below)

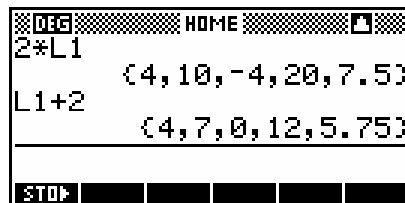

If we store another list of the same length into L2, then the two lists can be multiplied together. The resulting list is obtained by multiplying each element in the first list by the matching element in the second list.

Many of the normal mathematical functions also work on lists of numbers by performing the operation on each individual element. Lists on the hp 39g+ can contain more than simply numbers. For example, the return value for some matrix functions is a list where each element is a matrix. Elements of a list can be matrices, lists and other things..

The column variables C1, C2 . . . C9, C0 in the Statistics aplet are actually list variables attached to their aplet and can be used as extra storage if you need more list variables. The statistical variables have the additional advantage, of course, that they can be graphed in the Statistics aplet and with all the usual statistical analysis measures available. To transfer a list variable to a statistics variable, just store one into the other (see right). As you can see in the second view, the list has been transferred to C1. Pressing **STATS** would now give the usual statistical measures for the newly created column.

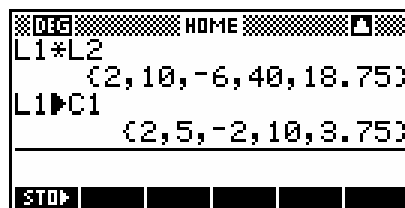

n	C1	C2	C3	C4
1	2			
2	5			
3	-2			
4	10			
5	3.75			

2  
 EDIT INS SORT BIG 2VAR STATS



There are also a number of special functions available for list variables which are contained in the *List* group of functions in the **MATH** menu. See page 265.

A special **List Catalog** is provided which allows easier entering and editing of lists. If you look above the 7 key you will see a label of **LIST** which gives you access to this catalog. When you enter this catalog you will see the screen on your right.

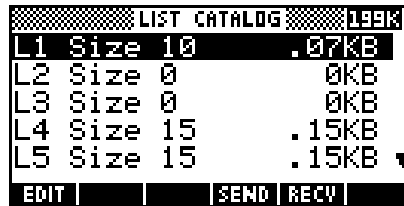

Pressing the **DEL** key when on one of these lists will delete that list, clearing the memory it uses. Pressing **BLUE CLEAR** (above the **DEL** key) will clear all lists. In both cases a query message pops up asking whether you are sure you want to do this.

If you press the **EDIT** key then you will enter a special editing screen which allows you to change individual values, delete values (using the **DEL** key) and insert new elements into a list. If you press the **INS** key with the highlight in the position shown, then a zero is inserted before the 4, with all the elements below shifted down one position. You can then type your new number.

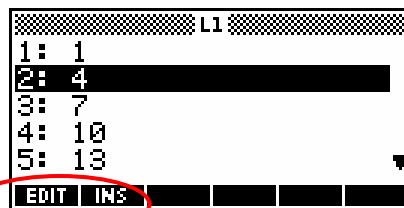

Having entered the editing screen, you may be wondering how to exit, since no key is apparently provided for this. Simply press **SHIFT LIST** again to return to the catalog level (or press **HOME** if you've finished altogether).

Changing of individual elements of a list can also be done in the **HOME** view, if not quite so easily. As we saw earlier, typing **L1** and pressing **ENTER** will display an entire list in the **HOME** view. If you want to see just element 3, for example, then typing **L1(3)** will display just that one element (see right). As you can also see, you can change just one element using the store command. It is not possible to insert an extra element, except in that you could add an element to the end of a list using the **CONCAT** function discussed on the next page.



Lists can be sent from one hp 39g+ to another using the infra-red link with the aid of the two keys labeled **SEND** and **RCV**. The procedure is the same as that for sending applets from one calculator to another.

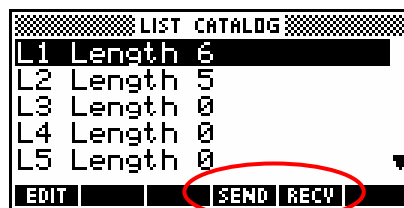

## USING THE NOTEPAD CATALOG

The hp 39g+ provides access to Notes which can be either attached to an applet or created as independent notes for any use. The notes belonging to the standard applets are blank unless you add to them, but copies you transfer from another calculator may have had notes added to them. In particular, any special applets you download to your calculator from the internet (perhaps via a teacher) may have instructions as a note and/or perhaps a sketch.

Every applet has a note attached to it even if it is blank. This note is available via a key labeled **NOTE** (above the **APLET** key). Thus an instruction to 'press **NOTE**' refers to the applet Note.

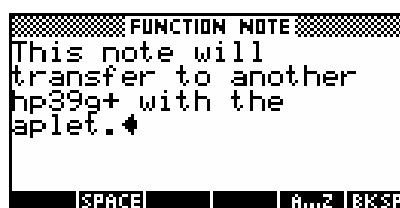

In addition to this, there is a **Notepad Catalog** containing independent notes which is available via a key labeled **NOTEPAD** found above the '0' key. Thus an instruction to 'press **NOTEPAD**' refers to the **Notepad Catalog**, not to the applet Note.

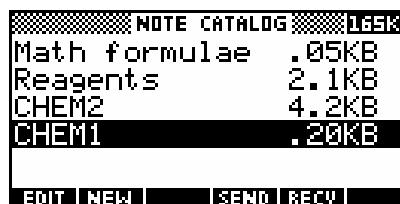

Notes attached to applets are explained in the chapter "Using, Copying & Creating Applets" on page 189, so only a brief example is given.

The Slope Fields applet is one that can be used to introduce calculus students to the concept of fields of slopes. It has been downloaded onto my calculator from the **HP HOME view** web site (<http://www.hphomeview.com>) on the internet and it is now found on the **APLET** key.



If this applet is run, the first thing visible is the **IEWS** menu. This menu is set up by the programmer to control the applet (see "Programming the hp 39g+" on page 214).



If you **CANCEL** the menu and press **NOTE** then you would see the Note attached to the applet. This is common with these applets. Since they are non-standard, the author ensures you have some instructions, although most of the documentation is generally in a Word® or PDF® document that comes with the applet. This particular set of notes consists of a number of pages, but most are not that extensive.

Some applets also have sketches attached to them but this consumes approximately 1Kb of memory per sketch and so was not common on the hp 38g, which only had 23Kb and so didn't have a lot to spare. On the hp 39g+, as programmers become used to having plenty of memory to use, applets have become larger and more powerful.

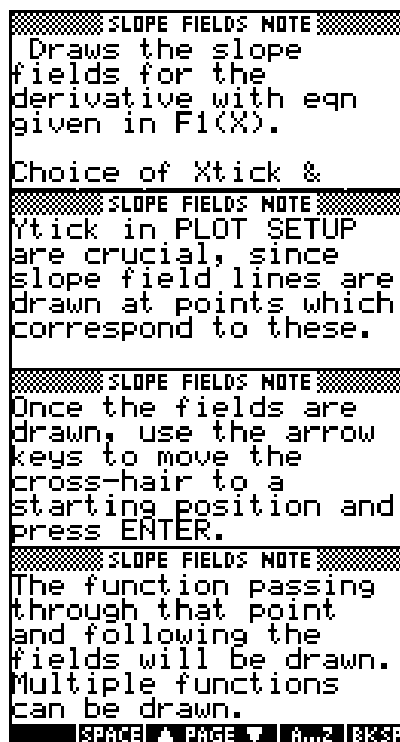

Applets may also have an attached sketch which is transmitted with it when it is downloaded. This is empty by default but programmed applets may use it. An example is shown right of a sketch from one of the applets available from HP's web site called 'Periodic'.

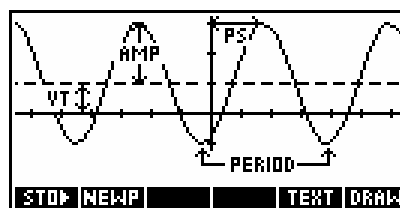

This can be viewed via the **SKETCH** key above the **MATH** key. Sketches can have multiple pages and are covered on page 184.

## ***Independent Notes and the Notepad Catalog***

Most users are far more concerned with the **Notepad Catalog**. Notes held in it are independent of any applet rather than being attached to only one, and can be sent to and received from another hp 39g+ or a computer via the **SEND** and **RECV** keys in the **Notepad Catalog**.

The **Notepad Catalog** can be used to hold an textual material. For example Physics information or your mathematics homework. As an exercise here, we will develop a stand-alone Note containing some common formulas.

*What notes you are allowed to keep and take into tests is a matter for your school's or university's policy. It is not a good idea to cheat by taking illegal material into a test or examination. Quite apart from any other reason, it could result in severe penalties.*



Notes can be shared between friends since they can be transmitted over the infra-red link in the same way as can be done for aplets, lists, matrices and programs. It is worth pointing out that this will not help you in a test situation, since the strength of the infra-red link in the hp 39g+ is such that it will only operate over extremely short distances. It's going to be pretty obvious what you're doing if you try to transmit messages by exchanging Notes in a test when you have to be within 8-10cm of your friend's calculator.

Notes also consume memory. Even on the hp 39g+, if you accumulate enough Notes you will eventually find that you run out of space. See page 37 for information on the hp 39g+ memory.

In addition to this, the hp 39g+ was never designed nor intended to be a typewriter. Inputting text is a slow process. As you begin to become more familiar with the positions on the keyboard where the various letters of the alphabet can be found your typing speed will improve, but it will never remotely compare to typing on a keyboard.

If you want to prepare anything more than small Notes then software is available to allow you to edit Notes on a computer. See page 211. For the hp 38g and hp 39g it is necessary to purchase a special cable to connect to the serial port on a PC and the software will work only on Windows computers. For the hp 39g+ the cable is supplied with the calculator to allow you to connect to the USB port. The hp 39g+'s software should work on either a PC or a Mac.

As was discussed on page **Error! Bookmark not defined.**, at the time of writing this book the software situation was in the process of changing so the information which follows may be out of date.

For the latest version of the software for your calculator you should consult Hewlett Packard's web site (<http://www.hp.com/calculators>) or *The HP HOME* view (at <http://www.hphomeview.com>).

## Software

### **For the hp 38g, hp 39g & hp 40g**

The HP Connectivity Kit, called HPGComm, is discussed in detail on page 204. It allows users to transfer applets and all other HP objects such as notes from calculator to PC via the serial port. It does not let you edit them in any way.



However there is also a free piece of software called the Aplet Development Kit available over the internet from HP's web site (<http://www.hp.com/calculators>) or *The HP HOME view* (at <http://www.hphomeview.com>) which edits notes & programs. See page 211.

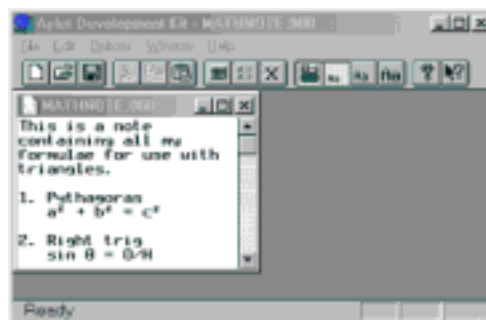

There are two versions of the ADK, one for the hp 38g and one for the hp 39g, hp 40g & hp 39g+. All of this software will only run on a Windows computer and requires that you have a cable and a serial port on your computer. Some newer models of computers do not have a serial port.

More information on both of these programs is given on pages 204 - 211.

### **For the hp 39g+**

At the time of writing the hp 39g+ had only just been released and new software was in the process of being developed. The hp 39g+ is supplied with a cable that lets it link to the USB port on a PC or a Mac. The software being developed should run on any platform, including Unix, and will allow the transfer of objects such as applets, programs or notes.

The Aplet Development Kit (see picture above) performs editing once the object is transferred to the PC. Make sure that you get the version of the ADK which edits objects from an hp 39g, hp 40g or hp 39g+. It will only run on a Windows computer and requires that you have a cable (supplied with the hp 39g+) and a USB port on your computer.

If you are reading this information then it might be worth checking to see if there is a newer version of this book available on HP's site. The intention at the time of writing was to update this section once the new software was released.

## Creating a Note

Let's create a small Note containing some commonly used formulas. Press **SHIFT NOTEPAD** (not **SHIFT NOTE**) and you will see the **Notepad Catalog** shown right. Yours will probably be empty.

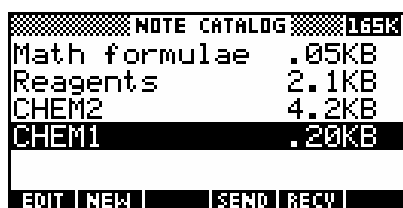

The keys at the bottom of the screen allow you to **EDIT** an existing Note, create a **NEW** one or to **SEND** and **REC** Notes to or from another hp 39g+ (or a computer). A Note is deleted using the **DEL** key, while the **SHIFT CLEAR** key will delete all Notes in the catalog.

Press the **NEW** key to begin a fresh Note. You will be presented with the screen on the right, requesting that you enter a name for the Note. Names can be any length and can contain any characters, alphabetic, numeric, spaces as well as any from the **CHARS** menu. However, if the name is longer than 14 characters it will be truncated in the display because of the space taken up by the indication of how much memory is used. When you press **ENTER** after typing in the name, you will see a blank screen waiting for you to begin typing in your Note.

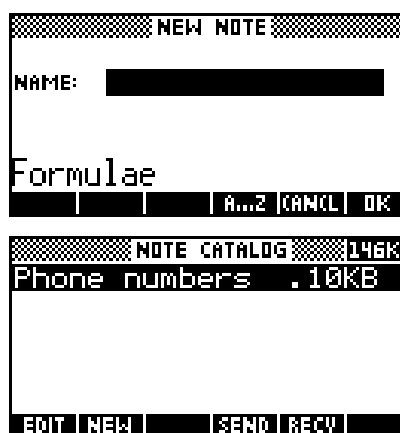

Before we begin, a word about making your typing easier. The normal method to enter an alphabetical character is to use the **ALPHA** key. Lowercase letters are obtained by pressing **SHIFT** first. The **ALPHA** key can be held down with one hand while you type with the other, but this isn't convenient and lowercase can't be locked this way. Space can be obtained via **ALPHA SPACE**, with **SPACE** located on the **+** key.

At the bottom of the screen in the Notepad view you will see screen keys labeled **A...Z**, **SPACE** and **BKSP** (backspace). If you press **A...Z** then all the keys from then on will type their alphabetic values rather than their normal mathematical functions. Pressing the **SHIFT** key first before the **A...Z** key will lock it into lowercase rather than into uppercase. Pressing the **A...Z** key again disengages it. The **SPACE** key is there purely for your convenience since it is also on the keyboard.

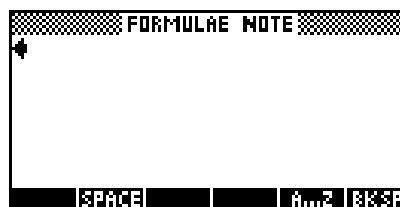

Use the keys discussed above to type in the screen shown on the right. The arrow keys can be used to move around in the text and insert or delete characters.

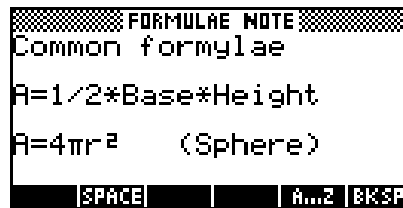

In this case we don't need it as all the characters are on the keyboard, but you should remember that additional characters can be obtained through the **CHARS** view. The three pages of the **CHARS** view are shown below. As you can see, there are many special characters available for use.



Once you have finished, and perhaps added some more formulas of your own, just press **SHIFT NOTEPAD** again to return to the catalog level. You will find that your new Note is now listed. There is no need to save your note, it is saved as you work - just exit when finished. Unfortunately this also means that there is no way to undo a mistake by reverting to a previously saved version.

You may wish to now try transferring your Note to a friend's calculator over the infra-red link using the **SEND** and **RECV** keys.

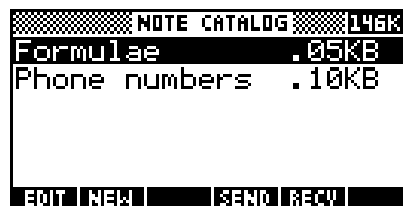

An occasional problem users encounter is finding that the Notes they have saved onto a computer are corrupted when they try to read them back. This is almost invariably caused by trying to open, read, print or otherwise tamper with the Note while it is on the computer. If you view the file once it has been stored by double clicking on it to try to open it then the computer may try to edit it with one of the word processors you have installed. If you allow this and save the result then all sorts of characters will be inserted into the file that will make it unreadable by the calculator. If you find that you have unintentionally opened a file in this way then exit from the word processor without saving.



**Calculator Tip**  
Only the proper software should be used to edit Notes on a computer.

## USING THE APLET SKETCHPAD

If you have not already done so, read the previous chapter. As is explained there, every applet has associated with it a Sketch, consisting of up to ten pages. It can be viewed by pressing **SKETCH**, which is located above the **VIEW** key.

Sketches for the standard applets start blank but you may find that an applet that you download from the Internet will have a Sketch attached. Remember a Sketch is always attached to an applet, so changing applets makes it inaccessible.

Facilities provided in the Sketch view are good for a bit of fun, but very primitive when you try to do anything at all complex. This is not meant as a criticism of the calculator. It does an extremely good job at what it was designed for - working with numbers - but it was never designed to compete with a computer drawing package.

When you first enter the Sketch page on your hp 39g+ you will see the view at the top right. There are four screen keys available. The **TEXT** key allows you to place strings of text on the screen.

If you press **TEXT** then you will be prompted to enter a string of text at the bottom of the screen. An **ALPH** key is provided to lock in alphabetic keys.

When you press **ENTER**, a rectangle will appear in the middle of the screen. The rectangle is the same size as the text will be. Using the arrow keys you can now move the text to the position in which you want it and then press **ENTER** again to fix its position.

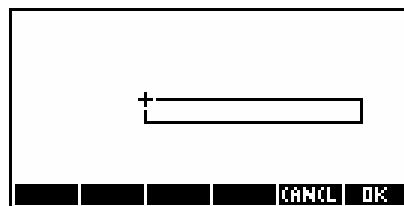



There are two font sizes available via the **BIG** key, with the default size being large. If you press the **BIG** key then it will change to **SMALL**. Although there is no apparent change when you are typing in the text, the font will become smaller when it appears in the window. Only uppercase is available in this small font. New sketch pages can be produced by pressing the **NEWP** key.



## The DRAW menu

The **DRAW** key gives access to a slightly enlarged menu of simple drawing tools. The **OK** key seen on the far right exits from this menu back to the original one.

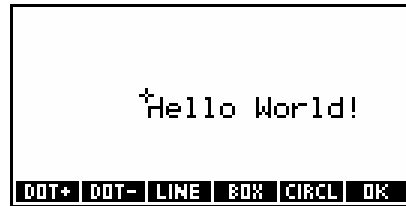

The small cursor (cross) in the middle of the screen can be moved around using the arrow keys. If you press the screen key labeled **DOT+** then a trail will be drawn as you move the cursor. Notice the small dot next to the **DOT+** showing that it is engaged.

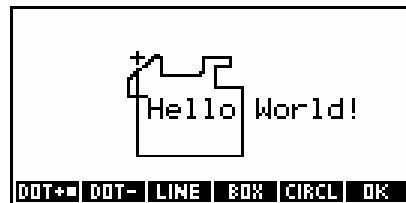

Pressing the **DOT-** key turns the cursor into an eraser (and automatically disengages **DOT+** as well). Pressing the same key again disengages both keys and leaves the cursor free to move with no effect on the Sketch.

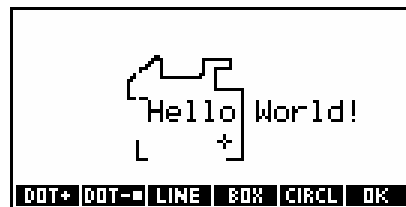

Moving the cursor to one end of a proposed line, you can now press the **LINE** key and move the cursor to the other end of the line. When the line is correctly positioned, press the **OK** key (or **CANCL**).



A box is drawn in the same way. Position the cursor at one corner, press the **BOX** key, move the cursor to the diagonally opposite corner and press **OK**.

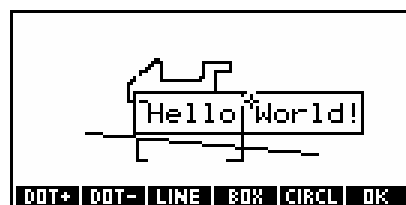

The circle command is similar. You should position the cursor at the center of the proposed circle. Pressing **CIRCL**, move the cursor outwards from the center, forming a radius. As you do so you will see a small arc appear, giving you an indication of the curvature of the circle.

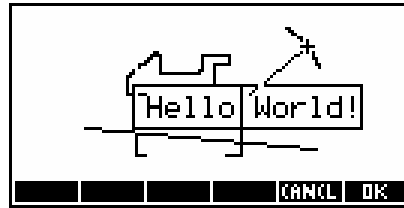

Pressing **OK** (or **ENTER**) will then complete the circle.

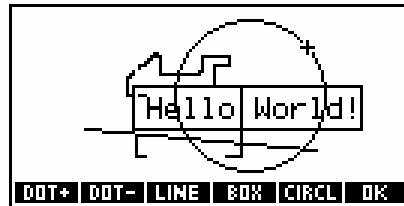

Finally, press **OK** to leave the drawing tools view.

Using the **STOP** key you can capture part of the screen and store it into any of ten graphics memories G1, G2 . . G9, G0 (called 'GROBs', which is short for *graphics objects*). When you press **STOP** the message you see on the right will appear, asking which GROB to use.



Once you have chosen a GROB in which to store the screen capture, you will need to specify the corners of the rectangle to be captured.

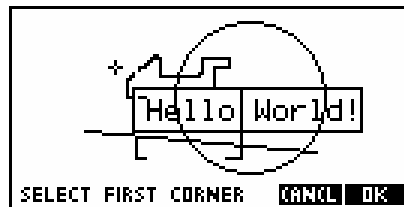

Once an image is captured, it is possible to paste the captured screen portion into the a Sketch page using the **VAR** key. The screen does not have to be blank but to make things clearer, create a new sketch page using the **NEWP** key (see right). Notice the appearance of a new **PAGE** key to allow movement between pages.



Press the **VAR** key and, when you see the screen shown right, press the key labeled **HOME**.

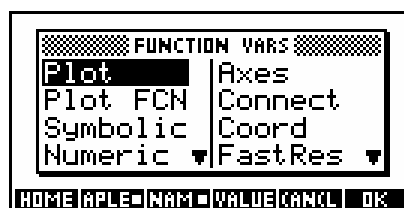

Move down through the menu until you reach *Graphic* and across to the particular GROB you chose. Now also press the key labeled **VALUE** and then press **OK**.

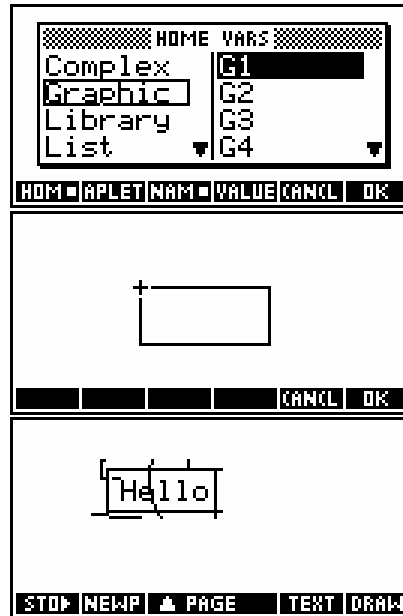

You will now find yourself back in the graphics screen with a rectangle representing the size of the GROB to be pasted in.

Move the rectangle to the desired position and press **OK**. The GROB will appear.

This technique can be very useful in building a Sketch, particularly when used in conjunction with the ability to capture **PLOT** screens and store them in GROBs (see below). You can also use it to create animations by pasting the same image in successively moved locations on each of the pages. Holding down the **PAGE** key will move rapidly through the sketches, animating them. If you can program then you can even automate the animation quite simply.

To capture a **PLOT** screen, just arrange the **PLOT** display so that it shows the features you wish to capture. For example, if you don't want the screen menu showing, make sure it is set up that way before you proceed. When ready, press *and hold down* the **ON** key, then press the **PLOT** key and release both. The screen will be automatically stored into GROB G0.

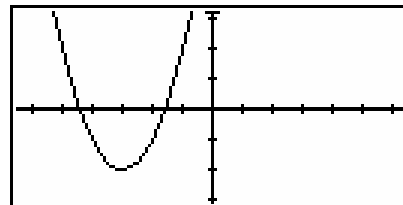

Now change into the sketch view, press the **VAR** key, select **HOME** rather than **APLET**, move the highlight to *Graphic* and then move it into the right-hand column and find G0. Press the **VALUE** key and then press **ENTER**. Unlike the previous example where the pasted GROB now had to be located on the sketch page, the captured screen in this case is a full size image and so will be pasted in as a fresh page not over an existing one.

Having pasted it into the Sketch page, you can now modify it by adding text and other information.

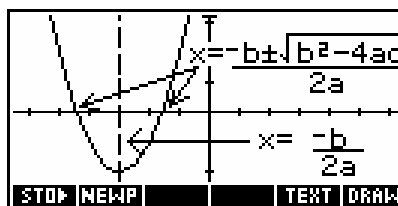

One has to question however whether the time needed to do this and the crudity of the result make the whole process worthwhile. If you're intending to do this to produce a set of 'cheat notes' for your next test or exam, you would do better to spend the time studying!



#### Calculator Tip

The screen capture facility demonstrated here can be used to capture any screen as a GROB, not just a PLOT screen. Pressing **ON+PLOT** at *any* time will store an image of the current screen into G0. See page 210.

## USING, COPYING & CREATING APLETS

Before you read this chapter, you should be reasonably familiar with the majority of the built-in aplets.

As has been discussed before, the designers of this calculator provided a set of standard aplets for you to use, changing the capabilities of the calculator as you change aplet. These standard aplets will cover most, if not all, of your requirements but to a certain extent you can also modify them to suit your needs and copy them for your friends. No programming is generally required and, unless you *want* to learn about the programming language of the hp 39g+, there is no reason to worry about it.

As well as making small modifications to the standard aplets, you can download additional aplets written by people who *do* enjoy programming. These aplets come via the Internet, but you may be able to obtain them from your teacher, from other hp 39g+ users, or from a PC or Mac onto which they have been copied. Once aplets have been copied from the Internet (onto a PC or Mac) the software and cable provided with your hp 39g+ can be used to download the aplets to the hp 39g+.



### Calculator Tip

Aplets which were written for the hp 38g or stored from an hp 38g are not compatible with the hp 39g, hp 40g or hp 39g+. On the other hand, aplets are freely interchangeable between any of the hp 39g, hp 40g and hp 39g+. A free utility is available which will convert hp 38g aplets into hp 39g+ aplets. Many of the aplets on web sites are available in both formats but far more are available for the hp 39g+.

The information which follows is discussed in the following order...

- [creating a copy of a standard aplet](#)
- [copying from hp 39g+ to hp 39g+ via the infra-red link.](#)
- [downloading from the Internet using the Connectivity Kit.](#)
- [saving notes, aplets and sketches via the Connectivity Kit.](#)
- [capturing screens using the Connectivity Kit.](#)
- [editing Notes with the Aplet Development Kit.](#)

The creation of new aplets on the hp 39g+ via programming is covered in the chapter which follows this one on page 212.

## Creating a copy of a Standard applet.

Imagine either of these two scenarios....

- (i) you are a student and you have filled the Function applet with a set of equations needed for tonight's homework and set up the PLOT screen so that it looks exactly the way you want it to. Now you find that you need the Function applet to do something else equally important which will mean wiping all that work.
- (ii) you are a teacher and you are planning a lesson where you will examine a collection of about half a dozen data sets and graph the results. You don't want to spend half the lesson waiting while the students type the data into the Statistics applet and then watch while they all use different axes and get totally different graphs.

In either of those two cases, the solution is to make a *copy* of the applet concerned. You can make as many copies of any of the standard applets as you wish, with the only limit being the calculator's memory.

Let's look at each of the two scenarios in turn.

In the first case, what the student needs to do is to make a copy of the Function applet to hold his homework (the functions he had already set up) and then do the unexpected extra work in the original Function applet which is now free.

Press the **APLET** key to see the list of applets. Move the highlight to Function (or whichever one you wish to copy) and press the screen key labeled **SAVE**.

You will now be asked to nominate a name for the newly created applet. It is a good idea to name it something that will remind you of its purpose and contents later. After all, you may end up saving it permanently onto a PC or Mac using the Connectivity Kit and when you look at it six months from now a name of "Homework" is not going to tell you much. Your name can contain spaces and any other characters, including those from the **CHARS** menu.

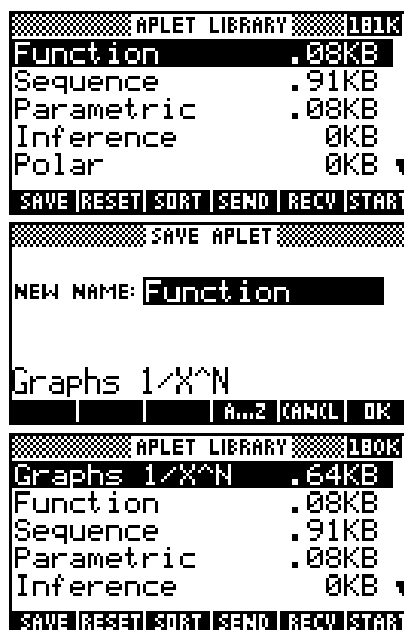

Our student's newly created copy of the Function applet is now totally independent of its parent applet. She can now (if she wants to) **RESET** the original Function applet back to factory defaults and go on with the extra work that she wanted to do. A saved applet cannot be **RESET**.

Our second scenario had a teacher not wanting to waste the time that would be needed for his students to type in five sets of data. In this case also, the solution is to make a copy of the applet - in this case of the Statistics applet.

First set up the Statistics applet to be exactly the way you want it... for example five data sets of 20 numbers, **NUM** view set to univariate stats (**UNVAR**), **SYMB** view set up for five *Box and Whisker* graphs, axes set up to display all five sets. See page 122 for information on the Statistics applet.

n	C1	C2	C3	C4
1	1	2	-5	-2
2	2	4	-4	-5
3	3	10	-1	-14
4	4	8	-2	-11
5	5	16	-2	-23
6	6	10	-1	-14

1

EDIT INS SORT BIG UNVAR STATS

STATISTICS PLOT SETUP

STATPLOT: **Box** HWIDTH: 1

WRNG: -30 20

YRNG: -2 10

HRNG: 0 20

SELECT STATISTICS PLOT TYPE

CHOOS PAGE 7

STATISTICS SYMBOLIC VIEW

✓H2: C2 1

✓H3: C3 1

✓H4: C4 1

✓H5: **C5** 1

ENTER SAMPLE

EDIT ✓CHK C SHOW EVAL

HH.Q1: -15.5 MENU

APLET LIBRARY LOOK

Related sets 1.5KB

Statistics 0KB

Related sets .14KB

Graphs 1/X^N .64KB

Function .08KB

SAVE RESET SORT SEND RECV START

The next stage is to move to the **APLET** view and **SAVE** this modified Statistics applet under a new name - say "Related Sets". If desirable, you might also **RESET** the original Statistics applet at the same time, ready for next use.

This saved applet can now be downloaded to all the students' calculators using the infra-red link, ensuring each student has the data sets, with its views pre-set to the teacher's needs.

An ambitious teacher might even complete his applet by adding a set of instructions to the Note which is associated with the applet. This would allow an absent student to download a copy from a friend's hp 39g+ and then read up on what they are supposed to do.

Indeed, if the students have access to the Internet and a Connectivity Kit themselves, then there is no reason that the teacher could not post the applet on the department's web page for downloading by any students who need access.

In both of these cases, the procedure has been to save a copy of one of the standard applets under a different name. In neither case was there any need to do any programming and the amount of memory taken up by these copies is fairly minimal because they share most of their resources with their parent applets.

## Some examples of saved applets

### The Triangles applet

In the **APPLET** view, **RESET** the Solve applet and **SAVE** it under the new name of "Triangles". Now **START** it and enter the formulas shown right.

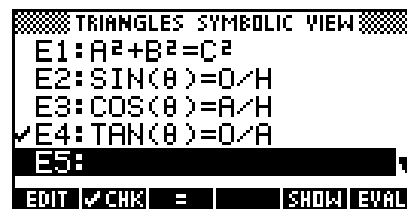

The **theta** character can be found in the second page of the **CHARS** view. Change into the **MODES** view and set the angle mode to *Degrees* (unless you want to use another mode). Use this to solve problems in right triangles.

### The Prob. Distributions applet

In the **APPLET** view, **RESET** the Solve applet and **SAVE** it under the new name of "Prob. Distr.". This applet is for use by students studying Probability Distributions, and contains formulas that can be used to perform calculations on the Binomial, Poisson, Exponential and Normal distributions. You can adapt it to the requirements of your particular course.

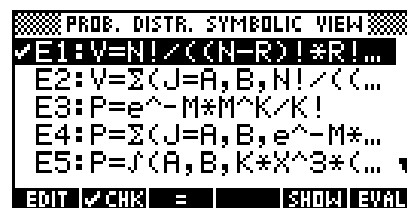

Firstly, **START** the applet and enter the formulas shown below and on the next page.

- E1:  $V = N! / ((N-R)! R! ) * P^R * (1-P)^{(N-R)}$
- E2:  $V = \sum_{(J=A,B, N! / ((N-J)! J! ) * P^J * (1-P)^{(N-J)}$
- E3:  $P = e^{-M} * M^K / K!$
- E4:  $P = \sum_{(J=A,B, e^{-M} * M^J / J!)$
- E5:  $P = \int_{(A,B, K * X^3 * (2-X), X)$



- E6:  $P=e^{-(K*A)}-e^{-(K*B)}$
- E7:  $P=UTPN(M, S^2, X)$
- E8:  $P=1-UTPN(M, S^2, X)$
- E9:  $P=UTPN(M, S^2, A)-UTPN(M, S^2, B)$
- E0:  $P=UTPN(M, S^2, M-K)+ UTPN(M, S^2, M+K)$

These formulas can be used in the NUM view to solve problems involving the probability distributions listed earlier.

Equations E1 and E2 can be used for calculations involving individual and cumulative Binomial probabilities.

eg. Find the probability of at most 3 heads when tossing a coin 10 times.

Ensure that formula E2 is  **CHK**ed and enter the values shown right. The value in J is irrelevant as it is merely the summation variable. Highlight V and press **SOLVE**.

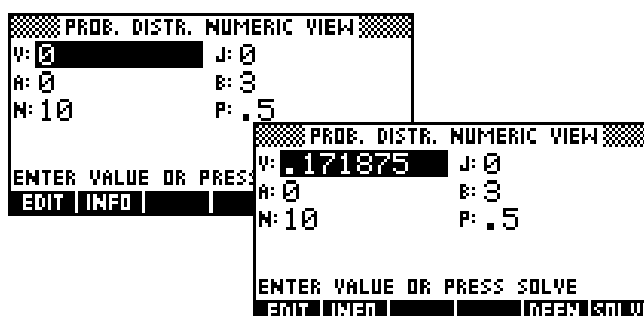

Answer: 0.1719

**Note:** If your summation involves more than about 25 terms then a normal approximation will be much faster than using this formula. Solve works by repeated iterations converging on the correct value and this will be quite slow if the summation has many terms.

Equations E3 and E4 can be used for calculations involving individual and cumulative Poisson probabilities, where M is the mean.

The formula in E5 is a generic formula for problems such as the one below:

“A probability distribution has the equation  $f(x) = 0.625x^3(2-x)$  ;  $0 \leq x \leq 2$  . Show that this is a valid probability distribution function and use it to find  $P(x \leq 1.2)$ ”

Use it by substituting whatever function is in use for the one currently entered. As this formula involves the integration function, each use of the solve process will require the hp 39g+ to perform multiple integrations. Because of this the solving process will be relatively slow.

Equation **E6** gives  $P(a \leq x \leq b)$  for an exponential distribution.

Equations **E7** to **E0** concern the Normal distribution, with **E7** giving  $P(X \geq x)$ , **E8** giving  $P(X \leq x)$ , **E9** giving  $P(a \leq x \leq b)$  and **E0** aiding investigation of questions such as “what distance either side of the mean will give a probability of 0.45?”.

**Notes:**

- (i) In equations **E1** and **E2**,  $N!/((N-R)!R!)$  is used rather than the more compact formula **COMB(N,R)**. Doing it this way allows the user to solve for **N**, whereas the second option does not. Note also that the resulting probability is given as **V** instead of **P** because **P** is already in use in the formula as the probability of an individual success.
- (ii) You might choose to split this into two applets - one for the Discrete probability functions and one for the Continuous ones.

**The Transformer applet**

This applet is based on the Parametric applet and allows students to investigate geometric transformations using 2x2 matrices.

In the **APPLET** view, **RESET** the Parametric applet and **SAVE** it under the new name of “Transformer”. Enter the equations shown right.

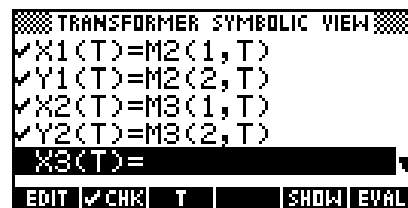

Change to the **PLOT SETUP** view and enter the settings shown right.

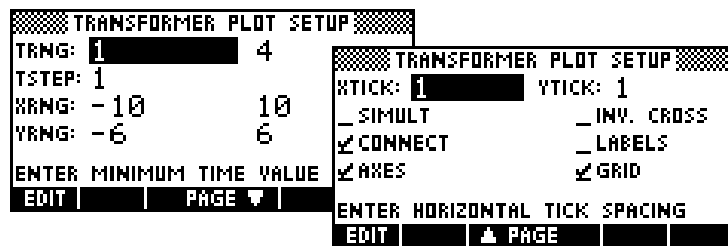

Now change to the **Matrix Catalog** view and enter the matrices shown below into **M1** and **M2**.

$$M1 = \begin{bmatrix} 1 & 0 \\ 0 & -1 \end{bmatrix} \quad M2 = \begin{bmatrix} 1 & 2 & 1 & 1 \\ 1 & 1 & 3 & 1 \end{bmatrix}$$

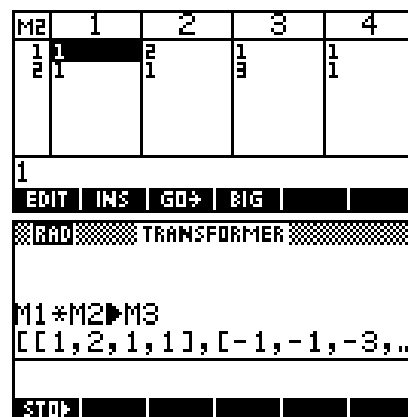

Change to the **HOME** view and perform the calculation shown right and finally press **PLOT**.

The result is a triangle with corners at (1,1), (2,1) and (1,3), along with its image after reflection in the x axis.

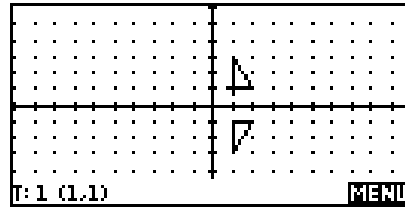

We can now **EDIT** matrix **M1** so that it contains another matrix. For example:

$$\begin{bmatrix} -1 & 0 \\ 0 & 1 \end{bmatrix}$$

To see the effect of this new matrix, simply return to the **HOME** view, **COPY** the previous calculation and press **ENTER**. The new image will be stored into matrix **M3**. If you now return to the **PLOT** view the image will not appear to have changed as the aplet does not realize the matrix has changed but pressing **PLOT** again will force a re-draw of the new image.

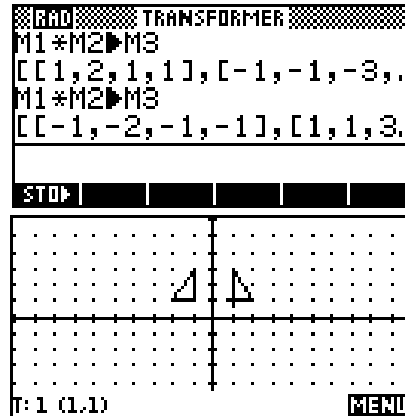

The power of this aplet as an investigative tool is that you can now continue to **EDIT** matrix **M1**, repeat the **HOME** calculation, and re-plot to see immediately the change in the image.

The degree of guidance which should be given to a class will obviously depend on their level of ability. You might choose simply to suggest that they confine their investigations initially to placing numbers only on the diagonals. It is a good idea to challenge them to record their matrices on the board as they discovered them. A highly able class will find nearly all relevant matrices within 20 to 30 minutes.

So... how does this aplet work?

The formulas in the **SYMB** view form the key to the process by allowing the calculator to fetch values from the matrices, with the values fetched being determined by the settings in the **PLOT SETUP** view. For example, as T runs from 1 to 4 in steps of 1 the (X1,Y1) values plotted become (M2(1,1),M2(2,1)), (M2(1,2),M2(2,2)), (M2(1,3),M2(2,3)) and (M2(1,4),M2(2,4)). If we now substitute the actual values from matrix **M2** then these points become (1,1), (2,1), (3,1) and (1,1), which give the shape when plotted. The repetition of the first point is to ensure that the line forming the triangle is closed by connecting back to its starting point. Obviously X2 and Y2 perform the same function with matrix **M3**.

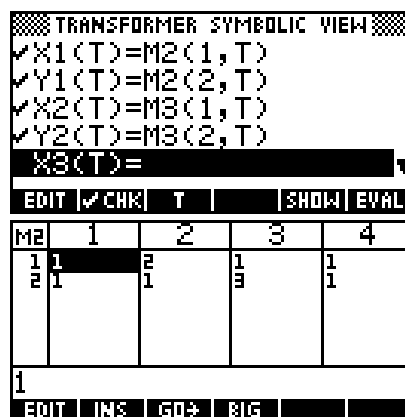

To use a different shape you need only change the points in matrix **M2**. If your new shape has more than three vertices you will need to change the **TRange** values in the **PLOT SETUP** view. It is not a good idea to use shapes that are symmetrical, like squares, as it makes it harder to recognize transformations.



#### **Calculator Tip**

Warning: Due to a bug which existed in the hp 38g and hp 39g, this applet cannot be sent from one hp 39g to another using the infra-red link. The formulas in the **SYMB** view often become corrupted during the transfer and need to be re-entered.

This is not a problem for two reasons. Firstly, the transfer would require sending not only the applet but the matrices too: by the time this is done it would probably have been faster to have the class set it up themselves. Secondly, if the class is not to regard this as 'magic' then they need to understand how the applet works. This is best accomplished by having them set it up themselves. You might even consider allowing them to first play with drawing shapes of their own invention using a single matrix and only X1 and Y1. This will show clearly why the **TRange** settings are important, and how the values are extracted from the matrix.

## Copying from hp 39g+ to hp 39g+ via the infra-red link.

Any aplet can be copied from one hp 39g+ to another via the built in infra-red link at the top of the calculator. Indeed it is not only aplets which can be copied, but lists, notes, sketches, matrices and programs. Of the family of related models, only the hp 40g does not have this capability.

The key to this ability is the presence of a screen key labeled **SEND** and its companion key **RECV**. This is shown in the **APLET** view on the right.



These keys can be used to send a copy of the highlighted aplet to any other hp 39g+.

The infra-red link is located at the top of the calculator, next to the socket which is used to connect the hp 39g+ to a computer. This link is exactly like the remote control of a VCR, and allows two calculators to talk to each other. In the interests of security in tests and exams, the distance over which they can talk is limited to about 8-10cm.

If you look at the keyboard side of the calculator, near the "hp 39g+" label above the screen, you'll find a small white triangle. This marks the position of the infra-red port so you can line them up when looking down from above. Put the two calculators top-end to top-end and line up the arrows with the calculators no more than 9-10 cm apart. The best separation is about 3-4cm.

The instructions which follow apply to the transmission of an aplet via the infra-red link but the process is the same for any other view which has **SEND** and **RECV** keys. The only difference is with the hp 40g, the version available in Europe. For this calculator the link is via a supplied calculator to calculator cable and you would choose *HP39/40 (Wire)* instead of the *HP39+ (IrDA)* specified on the next page.



To send an aplet, both calculators should be showing the **APLET** view, with the highlight on the aplet you wish to send. Now press the **SEND** key on the sending calculator and the **RECV** key on the receiving calculator.

On both screens you will see the pop-up list choices shown below. Ensure that the highlight is on *HP39+ (IrDA)*.

The other choices are:

- HP39/40G (Wire)
- Disk drive...



Note that the calculators are *not* directly in line with each other.



The first of these other two alternatives is there because the hp 39g, the predecessor to the hp 39g+, has a 'sister' calculator called the hp 40g. The hp 40g was released in Europe and has no infra-red link because the European education establishment were generally not happy with the idea of students being able to communicate by infra-red, even to the limited extent that is built into the hp 39g+. When you buy an hp 40g in Europe it is supplied with a cable which allows you to use the physical port next to the infra-red window to send aplets from one hp 40g to another.

The second alternative is there for transmitting aplets to and from a PC or Mac via the Connectivity Kit, or to a special HP disk drive built for the HP38/39/40G family called the "Drive 95". The "Drive 95" was released at the same time as the original hp 38g but there was no demand for it and it is no longer manufactured. The overwhelming majority of users decided that if they wanted to save an aplet then they would send it to a computer using the Connectivity Kit.

When both calculators are showing the **SEND/RECV** menu and are lined up correctly, press the ENTER key. While the aplet is being transmitted you will see a similar message to the one shown right. When the transmission process is complete, the new aplet will appear in the APLET view of the receiving calculator.



If you see a message saying that there has been a “Time-out”, it may mean that you did not line the calculators up precisely enough or pressed **SEND** on one without pressing **RECV** on the other. The first thing they do is say the electronic equivalent of “Hi there” to each other, and if there is no answer from the other machine within about 30 seconds, this is the message you receive.



### Calculator Tip

The main cause of failure in communications is low batteries. Low batteries affect communications long before the warning symbol appears.

If your aplet is one that has been created by someone else, rather than simply a copy of one of the standard ones, then it will probably have one or more ‘helper’ programs associated with it. For example, almost all the aplets available from the Hewlett-Packard web site come with sets of up to 6 or 7 programs to do the work, and without which they are totally useless. As an example, the screen shown right contains a number of programs which belong to an aplet called “Coin Tossing” which can be downloaded from the web site *The HP HOME view* (at <http://www.hphomeview.com>).

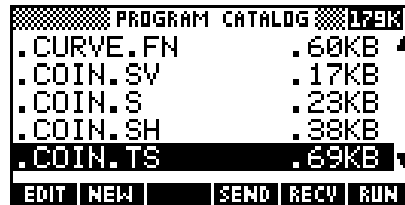

Normally you do not need to worry about this, since the calculator knows they belong with the aplet and will automatically transmit them with it. This can often greatly increase the transmission time. If you want to see these ‘helper’ programs, press **SHIFT PROGRAM** to see a list of the programs currently on your calculator. Even if there are no other programs currently stored, you will always see the ‘Editline’ entry. It contains a record of the last calculation you did in the **HOME** view and can’t be deleted.



Apart from curiosity, there is one important respect in which you need to know about these programs, and that is when it comes time to delete an applet. The helper programs must be deleted from the **Program Catalog** after deleting the main applet in the **APLET** view by highlighting the applet and then pressing the **DEL** key. For more information on this see page 207.

The advantage of having easy access to the Connectivity program is that it allows you to off-load any applets not being used onto a PC or Mac, which both have essentially unlimited storage in comparison with any calculator.

In addition to applets, there are many other data structures on the hp 39g+ which can be sent and received to other hp 39g+'s via the infra-red link. These include Lists (via the **List Catalog**), Matrices (via the **Matrix Catalog**), independent Notes (via the **Notepad Catalog**) and Programs (via the **Program Catalog**). Each of these has a **RECV** key and, unless the Catalog is empty, a **SEND** key. Any notes and sketches which are part of an applet (via the **NOTE & SKETCH** keys) will be transferred with the applet.

## ***Downloading applets from the Internet***

Applets are available to do many tasks such as exploring graphs, bivariate and time series analysis, as well as many tasks called for in Physics and Chemistry. The number of web sites with applets is increasing with time.

### ***Finding applets***

The Hewlett-Packard site is the best starting point and can be found at <http://www.hp.com/calculators>. From that point you can follow the links to collections of material for the hp 39g+ as well as software and utilities. Other sites can be found that have been created by enthusiasts. One of the most extensive is *The HP HOME view*, found at <http://www.hphomeview.com>

If you own an hp 39g+ then you already have the required cable with which to download from the internet. If you own one of the earlier models then you need to invest in a Connectivity Kit to get the required cable.

Downloading an applet from the Web is very simple. Accessing the HP site will present you with a page which may be similar to the one on the right, although the appearance will probably have changed since this text was written.

<b>HP Aplet Master Index</b>	
<a href="#">2x2 SYSTEMS</a>	Solve 2X2 systems of linear equations using substitution, linear combination, and Cramer's Rule.
<a href="#">AREA MODEL</a>	Multiply first degree monomials and binomials.
<a href="#">DECIMALS</a>	Explore patterns and symmetry by ordering pairs of digits from the decimal expansion of certain fractions that have periodic decimals.
<a href="#">FACTORING</a>	Symbolically factor second degree trinomials in the form $Ax^2+Bx+C$ .
<a href="#">LAWS OF EXPONENTS</a>	Apply the laws of exponents to multiply and divide monomials and to raise a monomial to a power.
<a href="#">ORDER OF OPERATIONS</a>	Simplify expressions using the order of operations.
<a href="#">PERCENT</a>	Write ratios that will solve problems of the form A is B% of C.
<a href="#">SUBSTITUTION</a>	Evaluate expressions when given values for the variables.



Generally you will be able to click on a link for each applet and see a summary on screen, together with a link that lets you download that applet as a ZIP file.

A ZIP file is a special type of file which contains one or more compressed files. The reason for the compression is simply to allow you to download them from the Internet more quickly, and you should de-compress them as soon as you have them onto your PC or Mac. There are many programs which will de-compress ZIP files. The most commonly used Windows program is Winzip®, which can be found at <http://www.winzip.com>. The Winzip® program can also usually be found on the disks which accompany many computer magazines.



### Calculator Tip

It is **absolutely critical** that you decompress each applet into a separate directory. Each applet has two files (HP39DIR.000 & HP39DIR.CUR) which always have the same name. Decompressing two zip files containing applets into the same directory overwrites the first one's files with the second. The applet itself will not be harmed by this but the effect is to render it invisible to the calculator, since the two special files contain information which is sent to the calculator in order to tell it what the directory contains.

### Organizing your collection

Shown below and right is the contents of one directory in part of my collection.

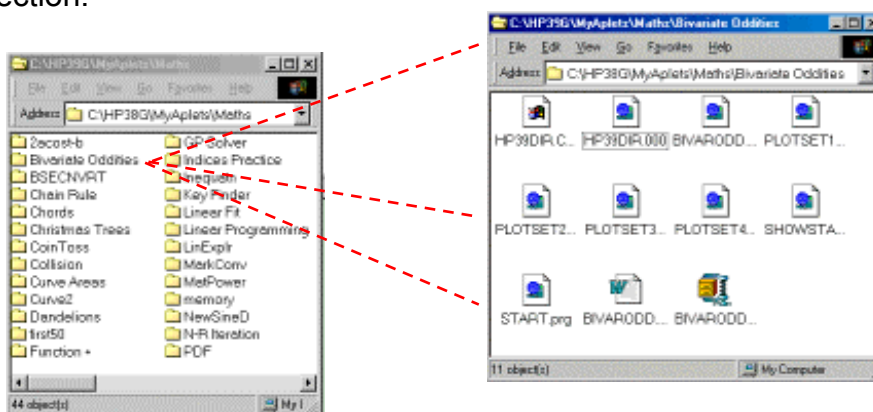

If you're only going to download a few applets then organization will not be as important. If you are a teacher or if you are intending to download lots of applets then you might consider setting up a logical structure of directories to contain them.

For example, at my school I set up a structure containing directories for each of the courses being run. In each of these directories I then set up further directories containing all the applets which were relevant to that course. In many cases that involved storing copies of applets in more than one place since some of them were relevant to more than one course.

Having downloaded our applet from the web to the computer, we now have the task of transferring it from the computer to the hp 39g+ via the Connectivity Kit. The Connectivity Kit consists of a cable and some software. For hp 39g+ users this is supplied with the cable but not for the earlier model calculators. More recent versions of the software will probably exist though.

### **Software for the hp 38g, hp 39g & hp 40g**

The HP Connectivity Kit, called HPGComm, is discussed in detail on pages 204. It allows users to transfer applets and all other HP objects such as notes from calculator to PC via the serial port. Its purpose is purely communication: it does not let you edit them in any way.

However there is also a free piece of software called the Applet Development Kit available over the internet from HP's web site (<http://www.hp.com/calculators>) or *The HP HOME view* (at <http://www.hphomeview.com>) which does allow editing once the object is transferred to the PC. See page 211.

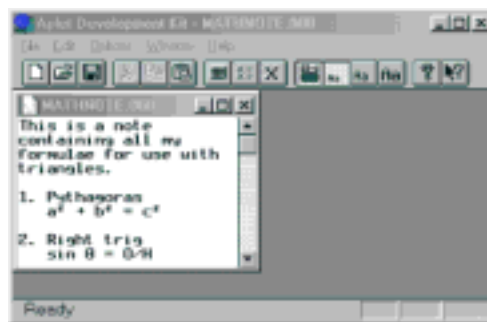

Note that there are two versions of the ADK, one for the hp 38g and one for the hp 39g, hp 40g & hp 39g+. You must make sure that you get the right version for your calculator.

Also, both HPGComm and the ADK will only run on a Windows computer although it may be that Mac and/or Unix versions will become available with time and enthusiasm. Using HPGComm requires that you have a cable and a serial port on your computer. Some newer models of computers do not have a serial port. This was one reason for the release of the hp 39g+, which uses the USB port instead.

### **Software for the hp 39g+**

At the time of writing the hp 39g+ had only just been released and new software was in the process of being developed. An image of the current Windows version is shown right but the final version may differ in appearance, perhaps significantly.

The hp 39g+ is sold with a cable included, unlike the earlier models. This cable lets it link to the USB port on a PC or a Mac. The intention is that the software being developed should run on any platform, including Unix, and will allow the transfer of objects such as aplets, programs or notes.

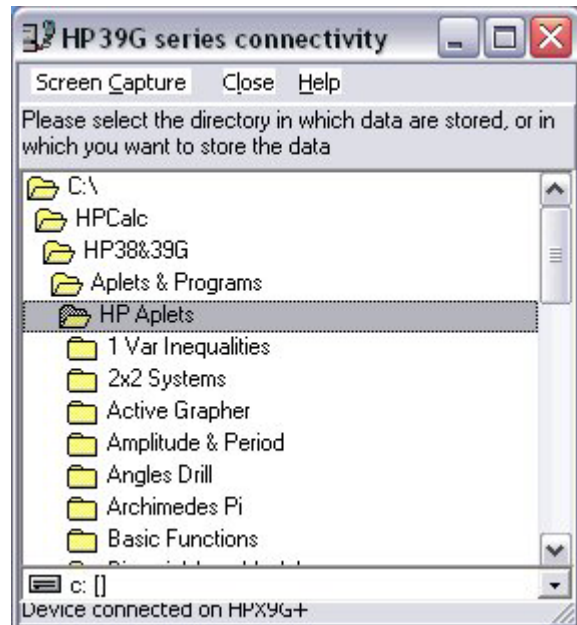

Once the aplet or note has been transferred to a PC it can be edited using the same ADK software as is used for the hp 38g, hp 39g and hp 40g. The only drawback with this is that the ADK will only run on Windows machines. It may well be that by the time you are reading this there will be new editing software specifically for the hp 39g+ and running on other platforms. Check the Hewlett Packard website for information on this. Information can also be found at *The HP HOME view* (at <http://www.hphomeview.com>).

***Most explanations & pictures which follow on the next two pages apply to the Windows software. They assume that you are using one of the earlier models (hp 38g, hp 39g or hp 40g) using the serial port for access.***

***More recent software may well be available by the time you read this.***

***See Hewlett Packard's web site at <http://www.hp.com/calculators>***

## The HPGComm Connectivity Program

At this stage I will assume that you have an hp 38g, hp 39g or hp 40g and you have installed the Connectivity software on your computer and have run it. If you have an hp 39g+ then the software will be similar in behavior although the appearance of the screens may be different. See page 181.



When you run the software you should see the screen shown above.

If you receive the error message right then it means that the default serial port COM1 is unavailable. Press OK and try changing to a different one from the list on the screen. You should read the comments below first.



Many computers released since 2002 only have USB ports. This was the reason why the hp 39g+ was altered so that it uses the USB port. If you own one of the earlier models this means that you will be unable to plug in the cable since it requires a COM port. If this is the case then you will need to buy a USB to Serial adaptor. Unfortunately these often cost more than the cable, but it will solve the problem.

If you are using the software on a school network then you may need to talk to the network administrator. Some school networks lock out ports for security reasons. Discuss your problem with the network administrator.

You can test whether the program is working by performing a screen capture (more on this later). Connect up the cable to the calculator, being firm but careful when plugging it into the top of the calculator so as not to bend the pins. Turn the calculator on and press **ON+1**. This means “press and hold down **ON** and, while still holding it down, press **1**”. If the connection is working correctly then a captured image of your calculator screen will appear. If it doesn't then check that you have fresh batteries in the calculator and investigate the use of a different serial port.



The first task is to tell the program where to find the applet. Press the *Change Directory* button and use the window that pops up to select the directory which contains the applet you want to transfer to the calculator. Your program's window won't be the same as mine.

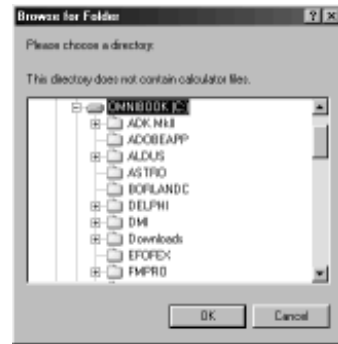

At the top of the window you'll see a message saying "Please choose a directory" and, once you've chosen a directory you should see "This directory contains hp 39g files" (if there are files there to be downloaded). Press the *OK* button to select the directory.

Having connected the cable to the calculator, change into the **APLET** view and press **RECV**. This time, choose *Disk drive...* from the menu which pops up. Press **ENTER**.

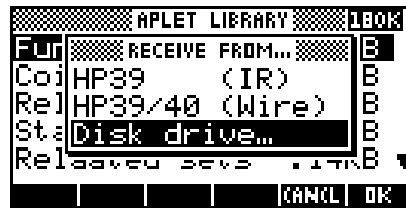

If you receive the message shown right, then it is probably caused by low batteries. However, it may be because you have tried to download the hp 38g version of the applet instead of the hp 39g/hp 39g+ version. It is normally only received if the directory is empty or if one or more files are damaged. Tell it **NO** and investigate.



If all has gone well, you should find that you are looking at another pop-up menu which lists the applet you are trying to download, together with the word 'Other..' If all you see is the word 'Other..' then it may mean that you haven't decompressed the applet properly or that the download was corrupted, and the applet is not readable. This is unlikely.



All else being well, if you now highlight the name of the applet and press **OK**, then you will then be entertained to a series of messages as the applet and all its associated programs transfer down the cable to your calculator. If there is insufficient room on your calculator then there will be an error message at some stage telling you this. If this happens you will need to delete the incomplete applet and however many of its programs successfully downloaded. Given the amount of memory on the hp 39g+, this is not likely.



## Using downloaded aplets

If you press the **VIEWS** key on your hp 39g+ you will see a list of options which vary according to which aplet is currently active. The **VIEWS** menu for Function is shown right.



Any aplet that has been created by a programmer, such as the *Curve Areas* aplet shown right, will generally have had its **VIEWS** menu modified by the person who created it.



The new **VIEWS** menu is used to control the aplet, offering a series of choices. Usually the intention is that you should work through the choices in the order that they appear. For example, in the menu shown here you would need to *Choose function* before you could use it to investigate areas under the curve using *Lower rect.*

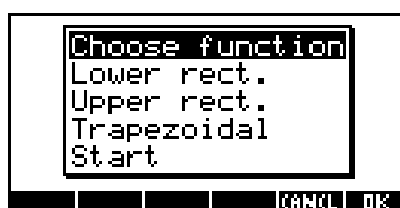

### Calculator Tip

If there is documentation with an aplet then you should read it. It often contains information which is needed for the efficient use of the aplet. It may also have one or more student worksheets which can be copied and used in a classroom.

Don't forget that these programmed aplets have 'helper' programs that are automatically loaded into the **Program Catalog**. When you delete the aplet these are not automatically deleted. You must change into the **Program Catalog** and delete them by hand. Left undeleted they will simply consume memory. See next page.

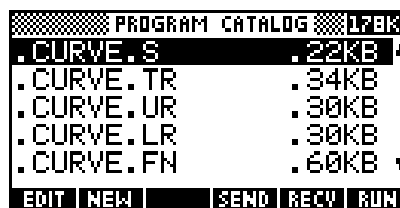

If you are a teacher using an hp 39g+ then it is highly recommend that you investigate teaching aplets. They can enhance your teaching greatly and, more importantly, put the learning process in the hands of the student where it belongs, by letting them control the process via their calculator. It is worth reading the information contained in Appendix A: Teaching Calculus with an hp 39g+ on page 301.

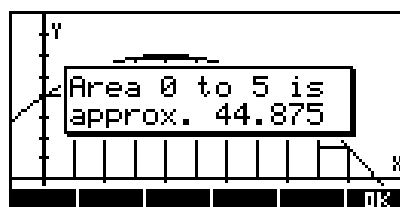

**Deleting downloaded aplets from the calculator**



As was mentioned earlier, most of the aplets you download will have ‘helper’ programs associated with them. These are stored in the **Program Catalog**. Apart from curiosity, there is one important respect in which you need to know about these programs and how to locate them, and that is when it comes time to delete an aplet. As you would expect, this is initially done in the **APLET** view by highlighting the aplet and then pressing **DEL**.

If the aplet is a simple copy of one of the standard ten, then that is the end of the process. However if the aplet has a set of one or more programs associated with it then those programs will not be deleted and will still be taking up memory. To delete these left over programs you will need to switch to the **Program Catalog** and remove them. Even on an hp 39g+ it is advisable to do this or your memory will gradually be used up.

As an example of this, look at the aplet called “Coin Tossing” shown in the **APLET** view right. Looking at the list of programs shown in the **Program Catalog** view, you will see a set of programs which all begin with the letters **.COIN**. The convention encouraged by Hewlett-Packard is to name the programs so that it is fairly obvious which ones belong to which aplet, hence the **.COIN** code for an aplet called “Coin Tossing”.



Simply position the highlight on each of the programs in turn and press the **DEL** key. If your calculator only contains one aplet with programs linked, then it is faster to use **SHIFT CLEAR** to delete all programs at once.

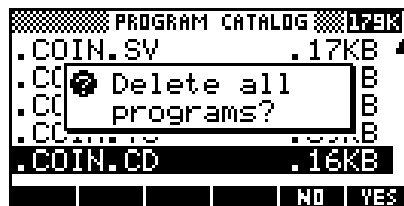

The **Program Catalog** view has no **SORT** key. If you store a large number of aplets then you may find that you start to have trouble telling what program belongs and what should be deleted. For the average user this probably will not be a problem. The naming convention should ensure that you are able to work out which is which. If you know the first letter of the name of the program then pressing that letter on the keyboard will take you to it.

## Saving notes, applets and sketches via the Connectivity Kit

The following information applies to the HPGComm program for the hp 38g, hp 39g or hp 40g. If you have an hp 39g+ then the software will be similar in behavior although the appearance may be significantly different (page 203).

Sending applets, programs, notes etc back to a computer is simply the reverse of the process covered so far. The only difference is that you need to create a directory to hold them first.

The Connectivity Kit software is capable of doing this for you. Just browse to the directory in which you want to create your new folder and click on 'Ok'. Now add to the path in the directory box by typing at the end of it. When you do this the middle icon (left) will activate. Clicking on it will create the new directory.

APLET LIBRARY		OPEN
MyFunction	.64KB	
Curve Area	1.9KB	
Function	.08KB	
Coin Tossing	1.8KB	
Related sets	1.5KB	

SAVE RESET SORT SEND RECV START



In the example shown right, I have created a directory called 'MyFunction' to hold a copy of the Function applet, which I have also called MyFunction, although it's certainly not important that they have the same name.

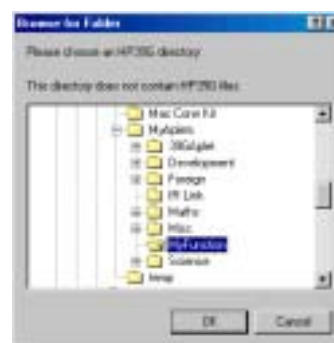

I now need to change into the view which shows the object I am trying to save and highlight it. In this case that's the **APLET** view. Most of the storage views have **SEND** and **RECV** keys, which means that you can also save programs, lists, matrices, and notes. Sketches can only be saved by saving the applet to which they belong.

Press the **SEND** key, choose the *Disk drive...* option from the menu and press **ENTER**.

APLET LIBRARY		OPEN
MyFunction	.64KB	
Curve Area	1.9KB	
Function	.08KB	
Coin Tossing	1.8KB	
Related sets	1.5KB	

CANCEL OK

APLET LIBRARY		OPEN
MyFunction	.64KB	
Curve Area	1.9KB	
Function	.08KB	
Coin Tossing	1.8KB	
Related sets	1.5KB	

CANCEL OK

The calculator will respond by asking if you want to *Send now*. Again, press **ENTER**. Don't use the *Pick location...* option.



If the directory is currently empty, then the calculator will display the image shown right.



### Calculator Tip

The meaning of the question about “Initialize directory?” is that the calculator has tried to find the two special files HP39DIR.000 and HP39DIR.CUR which tell it what files are in the directory and has, of course, been unable to retrieve them since it is an empty directory. It is asking if it can go ahead and create them itself.

The program will respond with message shown right. As it says, you should press the **YES** key on the calculator to continue the process.

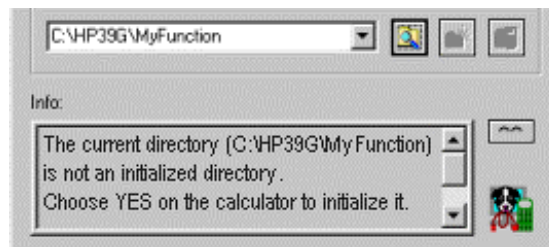

You will then see a series of messages on the computer and on the calculator telling you that files are being transmitted. At the end of the process your applet (or program, note etc...) will have been saved.



You can re-use this directory later to save any other objects from the calculator. Next time you use it you will not see the message asking if you want to “Initialize directory?”, as the two special files are now present. They will be automatically updated each time you save to the directory.



### Calculator Tip

DO NOT edit, rename, or otherwise interfere with these files once they are on the computer. If you do then you risk corrupting them so that the calculator can't read them. If you want to edit a note or applet on the computer then use the right software.

## Capturing screens using the Connectivity Kit

One of the most powerful abilities of the Connectivity Kit is its ability to capture images of the calculator screen. These images can be pasted into a document or into a Paint program for further processing. This allows teachers to create worksheets that include images of what the student should see. Students can create reports that include graphs and tables from your calculator.

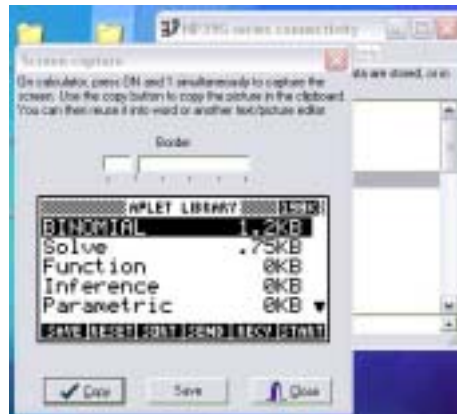

Any screen can be captured at any moment, even if it is only partially drawn. The capture is triggered by pressing **ON+1**. This means holding down the **ON** key and, while still holding it down, pressing and releasing the **1** key then **ON**. When you do the image appears on the computer. The images to the right and above show the screen capture process on the two different pieces of software. See page 203.

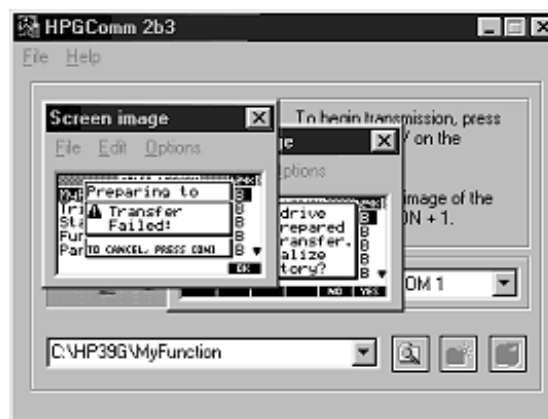

Once the image is captured, the Options menu on the HPGComm software package allows you to perform simple tasks such as putting a border around the image, and rotating or resizing the image. The File menu will allow you to save the image as a BMP file.

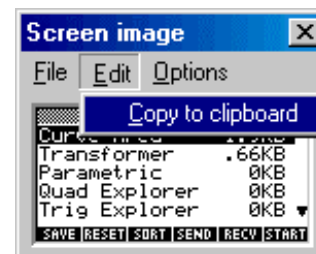

The software for the hp 39g+ also has options to allow you to copy the image to the clipboard, or to save it as a BMP file.



The Edit menu on HPGComm has a single option of *Copy to clipboard* which allows you to transfer the image into any other software capable of receiving it. Windows *Paint* is suitable. Most word processors will also accept images pasted directly from the clipboard.

A variation of this capture process is useful if you want to retain the image on your calculator. Pressing **ON+PLOT** stores the image into graphics object G0. This can then be pasted into a sketch using the **VARs** menu. From the **Sketch** view, press **VARs** and then the **HOME** key. Scroll down to the Graphics variables and select G0. Now press **VALUE** and then **ENTER**. The image will be pasted into your sketch and you can then use the drawing tools to edit it. Using a Paint program is easier and quicker.



### ***Editing Notes with the Aplet Development Kit***

Free software is available to let you edit Notes and aplets on a Windows computer from any of the hp 38g, hp 39g, hp 40g or hp 39g+. This software is called the Aplet Development Kit (ADK) and it is also used to create and program aplets. Here we will look only at using it to edit Notes. Similar software will probably become available for the Macintosh computers but was not available at the time of writing.

Since the aplets are the same for the hp 39g, hp 40g and hp 39g+ they can all be edited by the ADK. The only difference for the hp 39g+ is that the software used to get it onto the computer is different. See page 203.

If you have downloaded, installed and run the ADK software you should see the screen shown right.



Using either the File menu or the  button, open the directory window and work your way into the directory in which you have stored your Note file. Highlight it and click on the *Open* button.

You can now type your text into the Note using the normal computer keyboard. The special characters that are normally available from the **CHARs** view are also available via the  button.

When you've finished editing you can use the Connectivity Software to transfer the result back to the calculator.

## **PROGRAMMING THE HP 39G+**

### ***The design process***

#### ***An overview***

Although you can choose to simply create programs which are self sufficient the whole point of working on the hp 39g+ is to use aplets. Hence this chapter will concentrate on the process of creating aplets with enhanced powers provided by attached 'helper' programs.

The key to the entire process of creating completely new aplets is the **VIEW**S menu and its controlling command function **SETVIEW**S. This function allows you to override the normal behavior of an aplet and superimpose new properties by linking in a set of programs written by you.

It is mildly deceptive to call these aplets "new", as they derive from one of the standard ones, but the modification of the **VIEW**S menu means that their final appearance and behavior can be very different to the aplet they derive from.

Essentially the process involves the following stages...

- Choose the parent aplet;
- Analyze the expected behavior and design the **VIEW**S menu;
- Write the 'helper' programs and attach them to the aplet using the **SETVIEW**S function;
- Add supporting documentation.

#### ***Choosing the parent aplet***

The first stage in the creation process is to decide which of the standard aplets you wish to make the "parent" of your new child aplet. For some aplets this may not matter, but for others this can be a very important choice. All the abilities of the parent are inherited by the child so the parent choice is crucial if your aplet requires particular abilities. The most commonly used parent aplets are the Function and Statistics aplets, whereas the Quadratic and Trig Explorers would probably not make good parent aplets, since they are specialized teaching aplets without the flexibility of the others.

If your new applet is going to be concerned with analyzing data then your best choice for a parent would probably be the Statistics applet. On the other hand if you were planning to write an applet to teach the behavior of graphs then the Function or Parametric applets would obviously be best. All the tools of the parent are available to the child, so consider carefully what tools you require.



### Calculator Tip

When designing applets you should consider using the ADK as it makes the process *far* easier. To use the ADK you must have the Connectivity Kit and for models before the hp 39g+ this means buying a cable. We will begin by assuming that you have only the calculator and create our first two applets entirely on the hp 39g+. We will then look at two more examples using the ADK.

### ***Naming conventions***

The process starts by making a copy of the parent applet and giving it whatever name you want to use for your new applet. This copy will form the core of your new applet. Decide also what prefix to use for the programs you will associate with your new applet. The prefix needs to be recognizably linked to the name of the applet, so that the user can know which programs to delete when they want to clear the programs out after deleting the applet from the **APLET** view after use.

For example, an applet called “Linear Equations” might have a list of programs:

.LINEQ.SV	.LINEQ.S
.LINEQ.EN	.LINEQ.DIS

The next stage is to plan your **VIEWS** menu. The **VIEWS** menu is the controller of your applet. It pops up when the user presses the **VIEWS** key or at a programming command, and offers a choice of options to the user. Most of the options in your **VIEWS** menu will be triggers for ‘helper’ programs you will write, and when the user chooses an option and presses **ENTER**, the appropriate ‘helper’ program will be run by the hp 39g+. When the ‘helper’ program terminates the calculator drops into whatever view you as the designer choose. For example, a ‘helper’ program might set up axes based on the data entered and then drop the user into the **PLOT** view.

## Planning the VIEWS menu

It is very important to the usefulness of your applet that you carefully plan the **VIEWS** menu to be clear, concise and user-friendly. It is possible to have sub-menus in the **VIEWS** menu by having your option call a program which then pops up another menu of options. This is usually denoted by an ellipsis (...) following the **VIEWS** option, such as the one below.

An example of the **VIEWS** menu from an applet is shown right. The applet is called "Time Series" and is designed to analyze time series data.

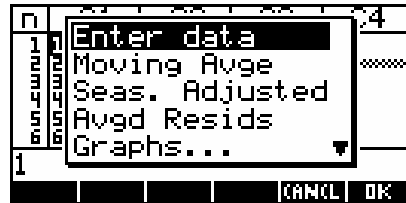

The parent applet for "Time Series" was the Statistics applet. This parent was chosen because of the need for the statistical tools it contains. For this particular applet most of the choices on the **VIEWS** menu trigger a 'helper' program to analyze the data in some way and then drop the user back into the **NUM** view showing the result. Some of the choices drop back into the **PLOT** view to see the data displayed.

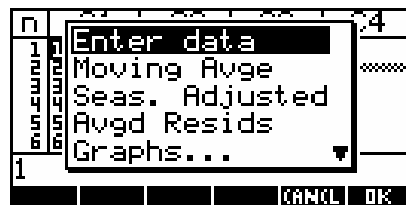

Sometimes choices trigger further menus. For example the last option of 'Graphs...' runs a program which pops up another menu, shown right. The reason for this method is generally simply to avoid overcrowding the main menu.

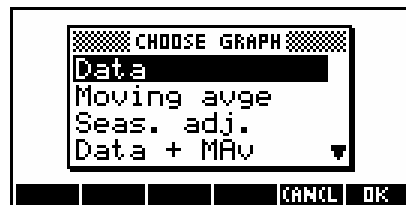

Another example of an applet is shown right. It is called "Tangent Lines" and it draws a tangent line onto a graph and then lets you move it around, displaying the gradient as it does so. This applet has the Function applet as its parent and displays the **VIEWS** menu shown right. In this case the menu has far fewer options.

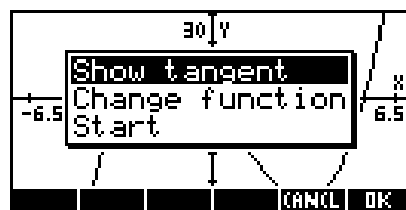

The **SETVIEWS** programming command which creates the **VIEWS** menu follows a repetitive pattern of listing a menu option, followed by the name of the program the calculator should run if the user chooses that option, followed by a code number which tells the calculator in which view to leave the user once the program finishes.

You should therefore also think about what you want the user to be looking at once the program they have triggered stops running. Do you want them to be looking at the **PLOT** view - perhaps the option they chose was to draw a graph, with the program being there to set appropriate axes; or the **NUM** view - perhaps we are analysing data - or should they be looking at the **VIEWS** menu again so that they can immediately make another choice?

The syntax for **SETVIEWS** is as follows...

```
SETVIEWS "Menu line1"; "Program name"; View_No;  
          "Menu line2"; "Program name"; View_No;  
          "Menu line3"; "Program name"; View_No: (colon on final entry)
```

where View\_No is:

- |                      |   |
|----------------------|---|
| 0. Home view         | 11. List Catalog                              |
| 1. Plot view         | 12. Matrix Catalog                            |
| 2. Symbolic view     | 13. Notepad Catalog                           |
| 3. Numeric view      | 14. Program Catalog                           |
| 4. Plot Setup        | 15. Views menu item 1 (Plot-Detail in Func.)  |
| 5. Symbolic Setup    | 16. Views menu item 2 (Plot-Table in Func.)   |
| 6. Numeric Setup     | 17. Views menu item 3 (Overlay Plot in Func.) |
| 7. Views menu        | 18. Views menu item 4 (Auto Scale in Func.)   |
| 8. Aplet Note view   | 19. Views menu item 5 (Decimal in Func.)      |
| 9. Aplet Sketch view | 20. Views menu item 6 (Integer in Func.)      |
| 10. Aplet Catalog    | 21. Views menu item 7 (Trig in Func.) etc.    |

The syntax for **SETVIEWS** allows any number of these triples.

The convention for the **SETVIEWS** command is to place it in a program with a name of **.NAME.SV** where **NAME** is whatever name you chose at design stage. When you run this program it severs the aplet's link to the normal **VIEWS** menu inherited from its parent and replaces it with the new options.



#### **Calculator Tip**

If an aplet is created using the ADK then it may not have this **.NAME.SV** program. The ADK creates the **VIEWS** menu in a different way that doesn't require it.

The linking process performed by the **SETVIEWS** command (or by the ADK) is also important in that it tells the calculator which programs are to be transmitted with the applet when it is copied via cable or infra-red link. Only those programs named in the **SETVIEWS** command (or linked by the ADK) will be transmitted.

In addition to the lines which form the menu for your applet, there are some special entries which are treated differently.

- i. If you include entries called "Start" or "Reset", then the 'helper' programs associated with those entries will be run when the user presses **START** or **RESET** in the **APLET** view.
- ii. If you include a menu line entry which consists of a single space character in double quotes, then the entry will not appear in the **VIEW**s menu, but the program named in the line *will* be transmitted with the applet. This can be handy if you have a program which is a subroutine. ie one which is not directly called in the menu but which is called by another program which is in the menu.  
Another example of this is the **.NAME.SV** program itself. It needs to be included in the list in this fashion, since we don't want it to appear on the **VIEW**s menu but it is usually kept and transmitted with the applet. Strictly this is not necessary since, once it has done its job, it would normally never need to be run again.
- iii. If you include an entry which consists of empty double quotes, then you can access the commands which appear on the parent applet's normal **VIEW**s menu which has been replaced by yours. The standard menu options of *Auto Scale*, *Plot-Detail* etc. can be included in this way. View numbers 15 onwards are reserved for this purpose. For example, if your parent applet was the Statistics applet in **EWAR** mode and you wanted to include its *Auto Scale* command then you would use a view number of 18 since *Auto Scale* is entry number 4 on the normal **VIEW**s menu for the Statistics applet in **EWAR** mode. You need to be quite careful when using this option since the commands like *Auto Scale* appear in different positions for different parents.

Shown below is a **SETVIEWS** program which illustrates this...

```

.TST.SV PROGRAM
SETVIEWS
"Opt. 1";".TST.A";0;
"";";16;
"";";18;
"Opt. 2";".TST.B";1;
STOP|SPACE| | |Am2|BKSP

```

producing a menu of...

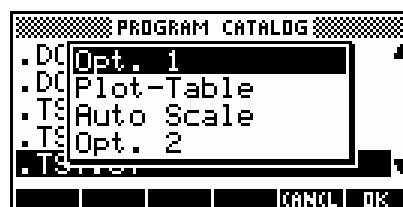



It is a very good idea to include a "Start" entry, since it will be automatically run when the user presses **START** and it thus allows you to enter pre-set values in variables, or to pre-set axes, so that the aplet runs smoothly. Additionally, if you terminate the "Start" entry with a view number of 7 then as soon as the user runs the aplet the **VIEWS** menu will be displayed (it is view number 7). This makes the aplet more friendly since the controlling menu is the first thing the user sees. Some aplets tend to opt for first displaying the Note view because they include instructions there. I usually opt for the **VIEWS** menu and include instructions in a separate file.

### Example aplet #1

This example will use the **SETVIEWS** command to design a very simple (and totally useless) aplet, which will illustrate a few of the concepts useful in programming the hp 39g+. We'll call it the 'Message' aplet and create it as a descendant of the Function aplet.

Change into the **APLET** view, move the highlight to the Function aplet and **RESET** it. Now save it under the new name of 'Message' and then **START** this new aplet.

You will find that you are looking at the normal **SYMB** view but for the Message aplet instead of the Function aplet.

Press **SHIFT PROGRAM** to view the **Program Catalog**. Press **NEW** to create a new program and call it **.MSG.SV** (see right, with part of the new program typed in)

Into this empty program, type the following code, obtaining the quotes from the **CHARS** view. When you finish typing, just press **SHIFT PROGRAM** again to exit back to the **Program Catalog**. There is no need to save as this is done continuously as you type.

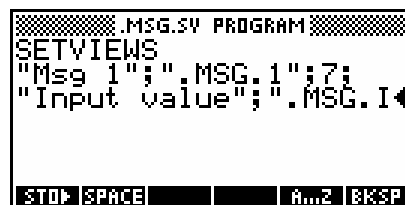
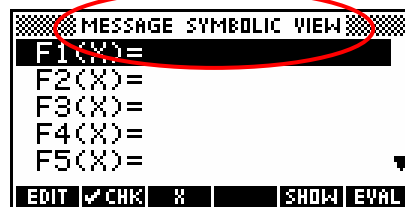
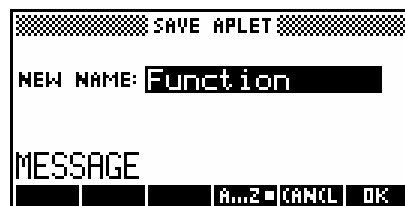
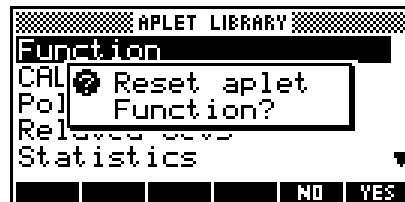

Spend a moment to go through the code and ensure that you are clear in your own mind the menu it will create, the programs it will run, and the views it will enter after the running of each program. You will be told at a later stage in this example when to run this program and create the menu.

We'll now create the associated 'helper' programs (shown below). Their names/titles are supplied above the code for each one.

.MSG.1	.MSG.IN	.MSG.2
<pre> .MSG.2 PROGRAM ERASE: DISP 4;"You entered "N: DISP 5;" when prompted.": FREEZE: STD SPACE     A...Z BKSP </pre> <p>ERASE clears the screen, ready to DISP a message on lines 4 and 5 of the screen. The calculator then FREEZE's waiting for a key to be pressed.</p>	<pre> .MSG.1 PROGRAM MSGBOX "Hello world! 3+4 = "3+4: STD SPACE     A...Z BKSP </pre> <p>The MSGBOX command is used to display the traditional first message for programmers learning a new language!</p>	<pre> .MSG.IN PROGRAM INPUT N;"MY TITLE";"Please enter N.:"; "Do as you're told.":20: MSGBOX "You entered " N" when prompted.": STD SPACE     A...Z BKSP </pre> <p>The INPUT command asks the user for info, displaying a title, prompt and tip and having a default value of 20.</p>
.MSG.FN	.MSG.S	
<pre> .MSG.FN PROGRAM ERASE: "((X+2)^3+4)/(X-2)"F1(X): →GROB G1;F1(QUOTE(X));0: →DISPLAY G1: FREEZE: ERASE: →GROB G1;F1(QUOTE(X));1: →DISPLAY G1: FREEZE: ERASE: →GROB G1;F1(QUOTE(X));2: →DISPLAY G1: FREEZE: ERASE: →GROB G1;F1(QUOTE(X));3: →DISPLAY G1: FREEZE: ERASE: LINE XminiYminiXmax;Ymax: BOX 3;3;-2;-2: FREEZE: STD SPACE ▲PAGE   A...Z BKSP </pre>	<pre> .MSG.S PROGRAM MSGBOX "Aplet starting now": STD SPACE     A...Z BKSP </pre> <p>The command →GROB in the program left, stands for "Graphic Object" and creates a GROB from the F1(X) expression stored in the SYMB view, storing it in the graphic memory G1, using the font specified (0, 1, 2 or 3). The reason for doing it this way is to use proper mathematical layout like SHOW does. The →DISPLAY command then shows it on screen.</p>	<pre> .MSG.SV PROGRAM SETVIEWS "Message 1"; ".MSG.1";7; "Input value"; ".MSG.IN";7; "Message 2"; ".MSG.2";0; "Show func."; ".MSG.FN";7; "Start";:".MSG.S";7; "Quit";:".MSG.SV";0; " ";:".MSG.SV";0: STD SPACE ▲PAGE   A...Z BKSP </pre> <p>The SETVIEWS command is discussed in detail on the previous pages.</p>

Having created all of the programs that make up the aplet 'Message', we can now run the program .MSG.SV, severing the aplet's link to its current VIEWS menu which was inherited from its parent the Function aplet, and substituting this new menu. *Before you do this*, check that you are still in the correct aplet. Press the SYMB key and check that the title at the top still says "MESSAGE SYMBOLIC VIEW". If it doesn't show this, then **START** the aplet again to ensure that it is the active one and so the one whose VIEWS menu will be changed.

Swap back to the **Program Catalog**, position the highlight on the program **.MSG.SV** and **RUN** the program. Apart from the screen going blank for a moment nothing will appear to happen, but in fact the link to the normal **VIEWES** menu which 'Message' inherited from its parent applet Function has been severed and a link to the new menu you built in **.MSG.SV** has been substituted. Press **VIEWES** to check.

Providing that you have done everything correctly, this is now the end of the process - the applet is now ready to be run. In the **APLET** view, make sure the highlight is still on the applet and press **START** or **ENTER** to run it. If you get an error message at any time then you may have to **CANCEL** and **EDIT** the program.

When you do this, the applet will run the program **.MSG.S** which will display a **MSGBOX**.



The line in the **SETVIEWES** command controlling this was:

```
"start";".MSG.S";7;
```

Since the triple ends with a view number of 7, this means that after the program terminates (when you press **OK**), the **VIEWES** menu will display again.

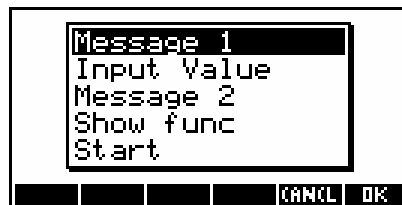

If you choose the option 'Message 1', then this will cause the program **.MSG.1** to be run, displaying the screen on the right. This line in the **SETVIEWES** command also terminated with a view number of 7 so when you press **OK** the **VIEWES** menu will display again.



The program line for this was:

```
MSGBOX "Hello world! 3+4 = "3+4:
```

Items in quotes are displayed as they appear, while expressions outside them are evaluated before being displayed. Expressions can include variables and calls to functions.

The next option in the menu is 'Input value'. Choosing this option will create an input screen. The statement controlling this was:

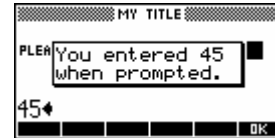

```
INPUT N;"MY TITLE";"Please enter N..";"Do as you're told.";20:
```

Examine the snapshot on the right and notice the connection between the various parts of the **INPUT** statement and their effect. Note the suggested value of 20, and note also that the prompt of "Please enter N.." was too long to be displayed. See the **PROMPT** command for an alternative that is simpler but less flexible.



When you enter a number into the input screen and press **ENTER**, the next line in **.MSG.IN** will display this value in a **MSGBOX**. When you then press **OK**, the view number of 7 specified in the relevant line of **.MSG.SV** will cause the **VIEW**s menu to be displayed again.

Notice that the input window is still displaying in the background. To stop this happening, you could have included in **.MSG.IN** a line of **ERASE: ,** which is a command to erase the display screen. Try editing the program, inserting this line before the **MSGBOX** line, and running it again.

The option of 'Message 2' displays the same message as we saw before, but presented in a different way. The **DISP** command divides the display screen up into 7 lines (1 - 7) on which you can display data.



For example, suppose memory A contained 3.56, then the command:

```
DISP 3;"The value of A is: "A:
```

would display the message **The value of A is: 3.56** on line 3 of the display screen.

Notice also that this time when you press **ENTER**, you end up in the **HOME** view rather than in the **VIEW**s menu again. This is not an error. If you look at the line in **.MSG.SV** controlling this option of the menu you will see that its post execution view number was 0 (**HOME**) rather than 7 (**VIEW**s menu) like most of the others. To see the **VIEW**s menu again, press **VIEW**s.

The final option is 'Show function'. The program this runs is a little more complex than the ones shown so far and illustrates a useful technique.

The line: `'((X+2)^3+4)/(X-2)' ►F1(X) :`

stores the expression  $\frac{(x+2)^3+4}{(x-2)}$  into the function F1(X).

Notice the way the function is in single quotes so that the algebraic expression itself is used rather than its value when evaluated using the current contents of memory X. If you wanted to graph this function by setting the post execution view number to 1 (the **PLOT** view), then you would need to include the command **CHECK 1:** in order to  **CHK** it or it would not graph. You may wish to edit the **.MSG.SV** and **.MSG.FN** program to try this.

The next lines display the expression using the four options available.

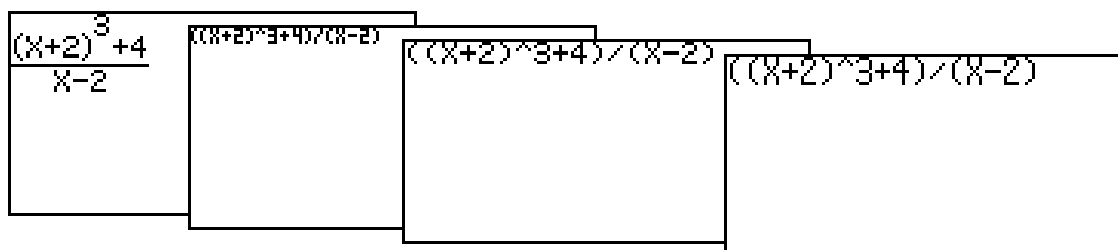

The line: `→GROB G1;F1(QUOTE(X));0:` converts the expression F1(X) into a Graphic Object (GROB). The number at the end, which changes with each repetition, controls the font used to display the function.

The line: `→DISPLAY G1:` displays this GROB on the screen, and the **FREEZE** command freezes the display until a key is pressed.

Finally the **LINE** and **BOX** commands are used to draw an oblique line across the screen and a box near the center. Notice the use of Xmin, Xmax, Ymin and Ymax in the **LINE** command. This means that the line would appear the same even if the screen were to be re-sized in the **PLOT SETUP** view. The **FREEZE** command is needed to ensure that your screen is visible to the user and not immediately replaced by the next view.

Note that **SETVIEWS** has a "Start" option and also a final option consisting of a single space in quotes which is simply to link in the **.MSG.SV** program so that it is transmitted with the aplet. It does not appear on the menu.

## Example applet #2

If you haven't already, read pages 194 which explain how to create a copy of the Parametric applet to explore geometric transformations using matrices. We will now look at using programming to enhance this applet by automating the process.

Start by highlighting the Parametric applet and pressing **RESET**. Now **SAVE** the applet under the new name 'Transformer'. Press **SHIFT NOTE** (not **NOTEPAD**) and enter some explanatory text into the applet's Note view. You can use the text shown right.

```

TRANSFORMER NOTE
This applet will let
you investigate geo-
metric trans-
formations using a
2x2 matrix.
Press VIEWS.
SPACE | A...2 | BKSP
    
```

The next step is to create the 'helper' programs for the applet, including the one containing the **SETVIEWS** command used to create a new **VIEWS** menu for the applet. These programs are shown on the next page. When you have typed them all in then **RUN** the program **.TRANSF.SV** to create the **VIEWS** menu.

```

Change matrix
Plot transf.
Change shape
Change axes
Start
CANCL | OK
    
```

Programs for the applet 'Transformer' are given below.

.TRANSF.SV	.TRANSF.S	.TRANSF.PLOT
<pre> .TRANSF.SV PROGRAM SETVIEWS "Change matrix"; ". TRANSF.MAT";7; "Plot transf."; ". TRANSF.PLOT";1; "Change shape"; ". TRANSF.SHAPE";7; "Change axes";";4; "Start"; ". TRANSF.S";7; " ";". TRANSF.SV";0; STO   SPACE   PAGE   A...2   BKSP         </pre>	<pre> .TRANSF.S PROGRAM -10Xmin:10Xmax: -6Ymin:6Ymax: 1Tmin:4Tmax: 1Tstep:1Connect: 1Grid:0Simult: 'M2(1,T)'X1(T): 'M2(2,T)'Y1(T): CHECK 1: 'M3(1,T)'X2(T): 'M3(2,T)'Y2(T): CHECK 2: [[1,0],[0,-1]]M1: [[1,2,1,1], [1,1,3,1]]M2: M1*M2M3: STO   SPACE   PAGE   A...2   BKSP         </pre>	<pre> .TRANSF.PLOT PROGRAM: XminZ:3Xmin:ZXmin: M1*M2M3: STO   SPACE   A...2   BKSP         </pre>
<p>This program sets up the <b>VIEWS</b> menu to call each of the other programs. It need only be run once at the creation of the applet, but is attached via the final line so that it will be sent with all the others if the applet is transmitted. The new user does not have to re-run it: it will never normally be run again.</p>	<p>This program sets up the required axes using variables from the <b>PLOT SETUP</b> view. It then loads the equations and ensures they are <b>CHK</b>ed and ready for use. Finally it loads the initial values into the matrices.</p>	<p>This program changes the value of Xmin and then changes it back. In the original version the user had to press <b>PLOT</b> to force a re-draw. This technique fools the hp 39g+ into thinking that the <b>PLOT</b> view has changed and therefore forces a re-draw without the need to press a key. It also re-multiplies the matrices in case the user has changed one by hand instead of going through the <b>VIEWS</b> menu.</p>

.TRANSF.SHAPE		.TRANSF.MAT
<pre> .TRANSF.SHAPE PROGRAM 1▶C: CHOOSE C;"SHAPE"; "Right triangle"; "Pointer"; "User defined"; IF C=1 THEN [[1,2,1,1], [1,1,3,1]]▶M2: ELSE IF C=2 THEN [[1,2,2,1.5,1,1], [1,1,3,4,3,1]]▶M2: ELSE DO EDITMAT M2: SIZE(M2)▶L0: IF L0(1)≠2 THEN MSGBOX"Matrix must be 2xN": END: UNTIL L0(1)==2 END: END: SIZE(M2)▶L0: L0(2)▶Tmax: M1*M2▶M3: STO▶[SPACE]▲PAGE   A...Z BKSP </pre>	<p>This program (left) uses the CHOOSE command to offer a list of options. Note the need to pre-load a value into C. This value determines which option is highlighted when the menu appears. If a list has only three options but the highlight is set to some other value than those three then it can crash the program. Options 1 and 2 load preset matrices while option 3 allows the user to edit their own. Note the check to ensure the matrix they entered has a valid size. The number of columns is then extracted and used to reset the value of Tmax. The new image matrix is also recalculated.</p> <p>The indenting used is not required and is there simply to make the program easier to read.</p>	<pre> .TRANSF.MAT PROGRAM MSGBOX"Enter the 2x2 matrix. Press OK when finished.": DO EDITMAT M1: IF SIZE(M1)≠(2,2) THEN MSGBOX"Matrix must be 2x2 only.": END: UNTIL SIZE(M1)==(2,2) END: M1*M2▶M3: STO▶[SPACE]▲PAGE   A...Z BKSP </pre> <p>This program puts up a message instructing the user and then allows them to edit the transformation matrix in M1. The size of the matrix is checked to ensure it is 2x2, with the DO...UNTIL loop ensuring that the user cannot exit without a valid matrix entered.</p>

Assuming that you have **RUN** the **.TRANSF.SV** program to create the new altered **VIEWS** menu then you can now test the aplet. Its operation should be familiar to you if you have already examined its 'cousin' on page 194.

In the next example we will use the Aplet Development Kit (ADK) to re-create the same 'Transformer' aplet used in example 2. This will allow us to concentrate on how to use the ADK rather than the aplet. The ADK runs only on Windows computers and was originally written for Windows 3.1. Because of this it does not understand long filenames or the Desktop and this makes it difficult to use at times. It may be that when you read this text new software will have been released by HP to supercede the ADK. The behavior of any successor is likely to be quite similar to that shown below since the basic design process is fixed by the calculator.

There are two versions of the ADK - one for the hp 38g and one for the hp 39g, hp 40g and hp 39g+. Aplets created by one version are not compatible with the other version's calculators. Look for the ADK on *The HP HOME* view (at <http://www.hphomeview.com>).

### Example aplet #3

Run the Aplet Development Kit and use the *File - New* command to see the box shown right. Enter 'Transformer' and nominate the parent aplet to be the Parametric aplet in the box provided.



When you press the 'OK' button the aplet will be created and its Note view will be displayed. Enter the text below as a hint to the user on how to use the aplet in case they don't have the documentation.

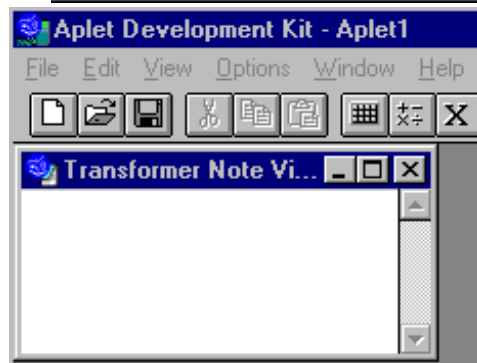

"This aplet will let you investigate geometric transformations using a 2x2 matrix. Press VIEWS to see the menu."

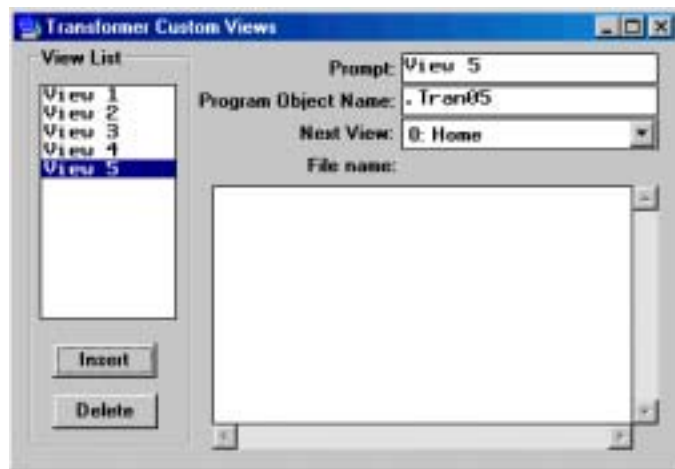

The next stage is to create the **VIEWS** menu. From the *View* menu, select *Special views...* and you will see the **VIEWS** menu creation screen. Press the *Insert* button five times to create the five entries we require for our menu. You can also create them one by one as required.



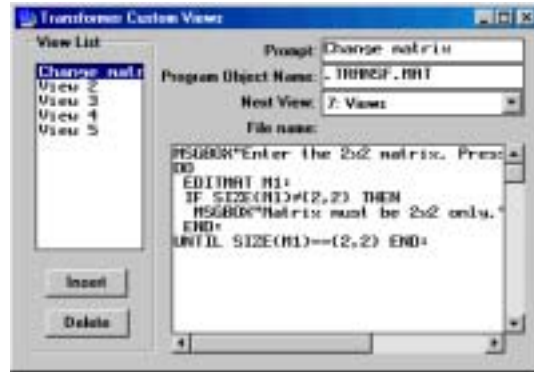

Click on “View 1” in the View List window. Change the prompt to “Change matrix”, the Object name to “.TRANSF.MAT” and the Next View to “7: Views”.



In the main window, enter the code for this program (see Example 2). Special characters such as  can be obtained from the  button.

We now must save the code. Click on the “View 2” entry in the View List window and the ADK will ask if you wish to save the code you entered for the first view. Tell it ‘Yes’ and a save dialog box will appear. At this point I usually realize I have forgotten to create a directory to hold my aplet and you may have too. If so, click on ‘Cancel’, and create an empty folder to hold the aplet. Remember that the ADK is a very old program and does not recognize long filenames. It only accepts names with up to eight characters and no spaces. This applies to directories also, so if you use ‘Transformer’ for your directory then you may find it appears in the ADK’s directory view as TRANSF~1, which is the Windows ‘short’ version.

Save the program under any name. I used EDITMAT.PRG. Make sure you are in the directory you created before you click on ‘Save’.

If you click again on the first view in the View List window you will find that it now records the filename you used.

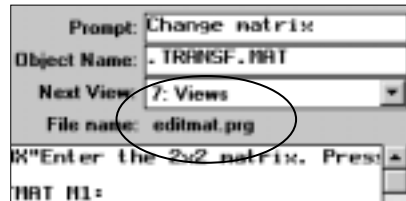

At this point you should also save the aplet itself, perhaps as TRANSFRM.APT.

Using similar methods, enter the code for the other programs, with two exceptions. Firstly, the *Change Axes* option has no program attached and you should leave the Object Name blank for that entry, simply specifying the Next View entry to be the **PLOT SETUP** view. Secondly, the program we used before to contain the SETVIEWS command is not required for aplets created by the ADK. When you finish, close the views planner and use the *File* menu to save the aplet also.

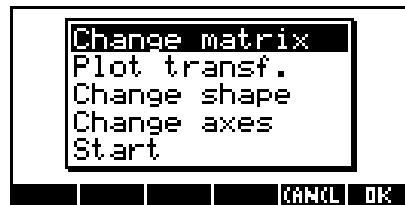

The final stage is to use the ADK to create the two special files HP39DIR.CUR and HP39DIR.000.

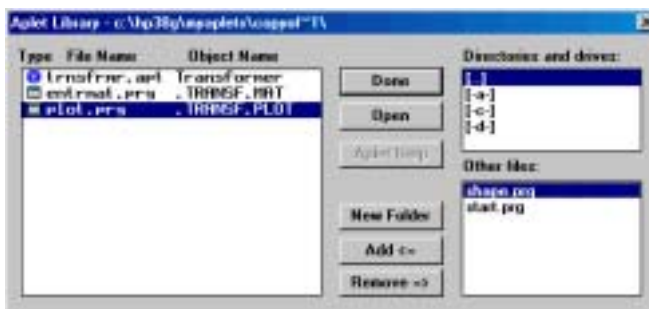

In the *File* menu, choose *Aplet Library*. You will see a list of the programs and the aplet in the window labeled “Other files”.

Click on each file in the right hand bottom window in turn to highlight it and then on the “Add <=>” button to add it to the library files. You can only add files which are legitimate calculator files. I usually add the aplet file first and then each of the programs in the order that they appear on the **VIEW**s menu, but this has absolutely no effect on the running of the aplet.

When you finish, click on the “Done” button and the files HP38DIR.CUR and HP38DIR.000 will be created. Exit from the ADK and the aplet is finished and ready to be transferred.

### **Example aplet #4**

The final example is a very useful aplet called “Linr Explorer”. The name would be better as “Linear Explorer” but names of more than 14 characters will not display properly in the **APLET** view. This will be somewhat similar to the Quad and Trig Explorer aplets, except that it will explore linear equations. Its parent is the Function aplet.

Create a directory to hold the aplet and then run the ADK. Use the *File - New* command to create an aplet called “Linr Explorer” with a parent of the Function aplet.

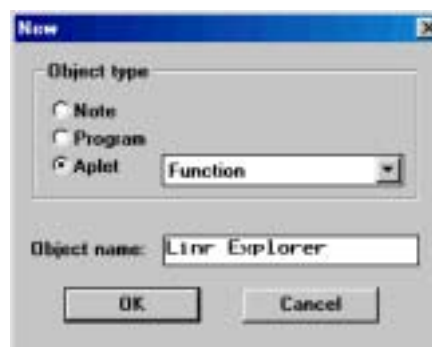

In the Note view, enter the text shown right.

Our **VIEWS** menu will only have three entries, so use the *View - Custom views...* command to display the menu planner and press *'Insert'* three times. Our **VIEWS** menu will be as shown below.



The first entry should have a Prompt of 'Plot axes', an Object Name of '.LINEXPL.AX' and a Next View of 1 (Plot view). The full code for each of the programs is given on the next page, and other settings are shown below and right.

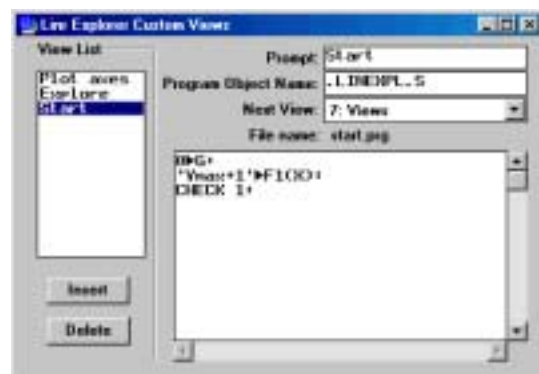
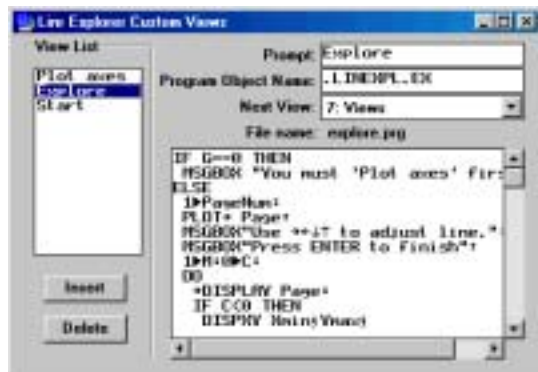
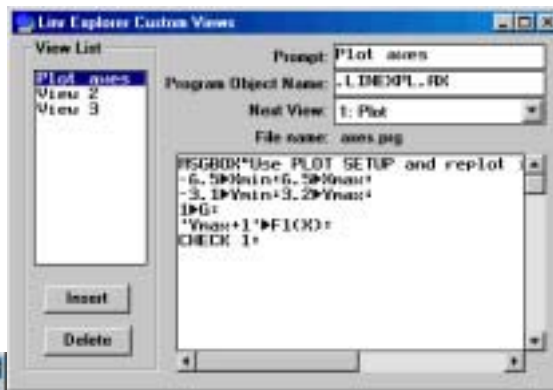

Save the applet and use the *File - Applet library* facility to create the two special files for the directory which allow the calculator to download it. Finally, download it to the calculator and test it.

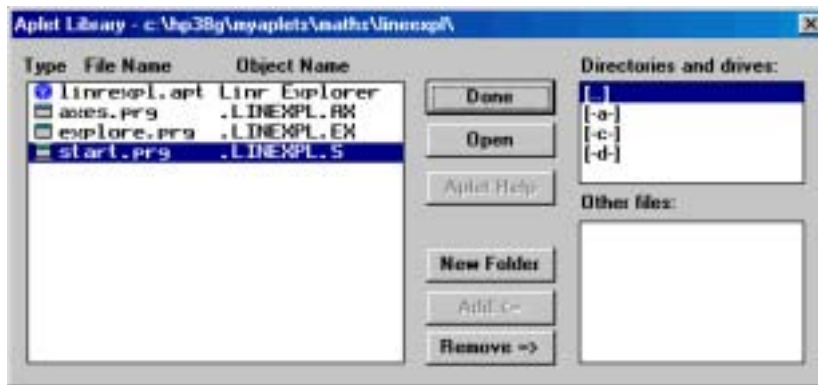

Choose the first option on the **VIEWS** menu to plot the axes and then the 'Explore' option to explore the equation of a line. On the pages following we will examine the code in detail, as it illustrates many highly important techniques.

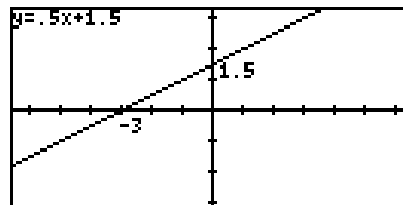

Since it is the first program run we will look first at the program .LINEXPL.S.

```
.LINEXPL.S PROGRAM
G:
'Ymax+1' F1(X):
CHECK 1:
-6.5 Xmin:6.5 Xmax:
-3.1 Ymin:3.2 Ymax:
STOP |SPACE| | A...Z |BKSP
```

The variable **G** is being used here as a flag. Before the 'Explore' option can be used we must be sure that the axes have been plotted, and this will be done by checking the value of **G**. Zero will mean 'unready' and one will mean 'ready'. When the 'Plot axes' option is run the value of **G** will be set to 1 and this will be checked before allowing the user to run the 'Explore' option. By setting it to zero in the program which is run when the user presses **START**, we ensure that the correct value is going to be in **G** initially. If this check is not done then the code used in .LINEXPL.EX will cause the program to crash, which is obviously not something we want. The axes are also set back to the default settings in case the user has changed them.

The 2<sup>nd</sup> and 3<sup>rd</sup> lines are there to insert a function. We need a function when the axes are plotted or the normal error message will be displayed (see right), which is undesirable as it confuses the user. On the other hand we need *blank* axes, so we use a function 'Ymax+1' which is guaranteed to be off-screen for the entire x axis range no matter what axes are used. Clever, eh?

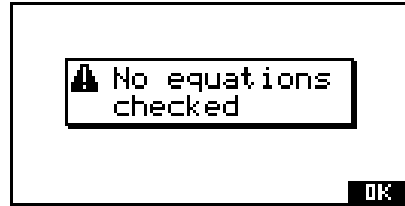

The next program code we will look at belongs to the 1<sup>st</sup> option on the **VIEWS** menu of 'Plot axes'.

```
.LINUXPL.AX PROGRAM
MSGBOX"Use PLOT SETUP
and replot if
different axes are
wanted":
1▶G:
'Ymax+1'▶F1(X):
CHECK 1:
STOP SPACE ▲ PAGE | A...2 | BKSP
```

A message is first given to the user of how to proceed if they want to use different axes. The flag value of **G** is then set to 1 so that the next program can tell that the axes are ready to use. The function is also re-entered in case the user has changed the **SYMB** view. Users have a habit of changing things so try to allow for this in your programs.

The next program below illustrates a very important technique where a copy of the **PLOT** view is stored in the aplet's sketch view and then retrieved and modified using the various graphics commands. The program is broken into parts for discussion purposes.

```
.LINUXPL.EX PROGRAM
IF G==0 THEN
MSGBOX "You must'Plot axes' first":
ELSE
1▶PageNum:
PLOT▶ Page:
MSGBOX"Use →←↓↑ to adjust line.":
MSGBOX"Press ENTER to finish":
```

The reason for the "IF G==0 THEN" is to check that the blank axes have been plotted and are available for use. If not then the user receives a message to tell them what to do and the remainder of the program is bypassed. Trying to capture a **PLOT** view that doesn't exist is a major error.

Still referring to the code on the previous page, you will see that it refers to **PageNum**. The sketches in the hp 39g+'s **SKETCH** view are numbered 1, 2, 3...etc. Sketch number 1 is always present but after that only sketches that have been created are available and the program will crash if you try to access one that does not exist. The aplet variable **PageNum** is the pointer to the sketch you want and the actual sketch is called **Page**. Thus the two lines after **ELSE** tell the program to store the **PLOT** view into the first page of the **SKETCH** view. The **PLOT** view *must* exist before this can be done or the program will crash. If you run the program and then later change to the **SKETCH** view you will be able to see this stored image. Finally, the user is presented with two messages which tell them what to do.

The next section begins the code which performs the work in the aplet.

```

1▶M:0▶C:
DO
  →DISPLAY Page:
  IF C<0 THEN
    DISPX Y Xmin;Ymax;1;"y="M"x"C:
  ELSE
    DISPX Y Xmin;Ymax;1;"y="M"x+"C:
  END:
  DISPX Y .3;C;1;C:
  IF M≠0 THEN
    DISPX Y -C/M;-.3;1;ROUND(-C/M,2):
  END:
  LINE Xmin;M*Xmin+C;Xmax;M*Xmax+C:

```

The first line assigns initial values to the variables **M** (gradient) and **C** (y-intercept). The **DO...UNTIL** loop which follows (partly in the next section of code) loops through the code within it until the **ENTER** key is pressed.

Within the loop, the previously stored **SKETCH** view is transferred from storage to the display using the **→DISPLAY** command. The equation of the current line is then displayed in the top left corner using the **DISPX** command. Two versions are needed to avoid an expression like "y=2x+ -1".

The **DISPX** command was a late addition to the calculator and was added at my request (many thanks, Jean-Yves and Cyrille!). It is a hugely useful command to programmers but because it was added at the last minute it does not appear in the manual for the hp 39g. It may have been added to the hp 39g+'s manual. It does appear in the *Prompt* section of the **MATH** menu.

The **DISPXY** command allows you to place a string of text at any position on the screen using two different fonts. Until this command was added to the language the only way to do this was to:

- save the current screen into a graphics variable.
- create a special GROB which contained the text.
- superimpose the GROB onto the stored image.
- redisplay the modified image onto the screen.

Quite apart from the fact that this was incredibly involved, it was very slow and the command to create the GROB was very limited in what it would allow.

The new command has the syntax:

**DISPXY <x-pos>;<y-pos>;<font#>;<object>:**

Suppose  $M=2$  &  $C=3$ . Then the command `DISPXY Xmin;Ymax;1;"y="M"x+"C:` will display the text "y=2x+3" using font #1 (small) at the top (Ymax) left (Xmin) of the screen.

The next line places a label on the y axis (offset slightly) to mark the y-intercept. A check is then done to see if an x-intercept exists and, if it does, a label is placed to mark it. Any labels off the edge of the screen will be ignored.

Finally the line itself is drawn. Even though part of the line extends off the screen there is no problem - the excess is clipped.

The next section of code below waits until the user presses a key (**GETKEY**) and stores the key's code into the variable **K**.

```
GETKEY K:
CASE
  IF(K==25.1)THEN C+.5▶C:END
  IF(K==35.1)THEN C-.5▶C:END
  IF(K==34.1)THEN M+.5▶M:END
  IF(K==36.1)THEN M-.5▶M:END
END:
UNTIL K==105.1 END:
END:
ERASE:
STOP|SPACE|▲PAGE|A...Z|BKSP
```

A **CASE** statement is then used to check for the use of the arrow keys. Notice the lack of colons (:) after each **END** in the **CASE** statement.

If the left or right arrows have been pressed (keys 34.1 or 36.1) then the line is 'twisted' by changing the value of **M**. If the up or down arrows have been pressed (keys 25.1 or 35.1) then the line is raised or lowered by changing the value of **C**. See the manual for more information on the **GETKEY** and **CASE** commands and on key values.

The final check in the line **UNTIL K==105.1 END:** is to see if the user has pressed the **ENTER** key. If so then the loop will terminate and the screen will erase. If not then the loop begins again with the new line being displayed. On termination of the program the **VIEWS** menu will display again, because we chose this when designing the applet in the ADK.

This applet illustrates most of the commonly used programming techniques. If you would like to gain experience then I suggest that you do as I did - download applets and pull them apart to see how they work.

If you would like to further enhance this applet then try the following:

- change the order of the code so that the labels are drawn after the line, thus ensuring that the text is never obscured by the line.
- add a new variable **D** to allow the size of the increment to change. Set an initial value of **D** of 0.5 at the same point as the values of **M** and **C**. Then change the lines above so that **D** is added/subtracted instead of 0.5. Add two more **IFs** to the **CASE** statement so that if they press '+' the increment doubles, and if '-' then it halves. You will also need to add another message box line telling them about this. Finally, add a line to display the current increment size at the top right of the screen using the **DISPXY** command.

The explanation so far should help you in understanding the programming process on the hp 39g+. The applet structure is well designed and, if you take advantage of the **VIEWS** menu structure, offers easy creation of complex and very powerful teaching applets. Certainly what has been discussed here is enough that a programmer will be able to make a start without some of the errors that I made.



## PROGRAMMING COMMANDS

All programming commands can be typed in by hand but, as with the **MATH** commands, can also be obtained from a menu. Press **SHIFT CMDS** to display this.

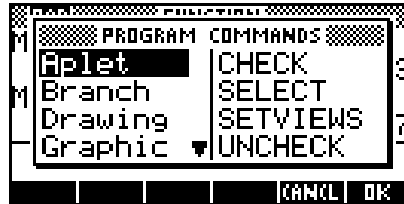

In this section I will only be covering those commands which I have used regularly and so regard as important. These may not be the same as the ones you regard as important. If so, consult the manual.

### *The Aplet commands*

These control aspects of the aplet.

#### **CHECK *n*, UNCHECK *n***

These commands put or remove a check next to the equation whose number is given by *n*. An interesting bug is actually quite useful: if you **UNCHECK 0** then all equations are unchecked instead of only equation 0. Unfortunately the same is not true for the **CHECK** command. As they say in the trade: "It's not a bug, it's a feature!"

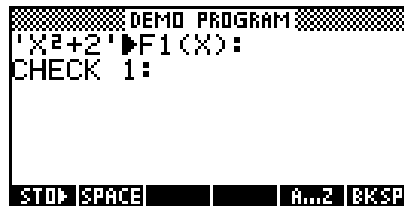

#### **SELECT <name>**

This is used to set the active aplet if necessary. If the name has spaces in it then it must be enclosed in quotes. This is not usually required as the program will normally be called by the active aplet anyway. I have only used it with 'stand-alone' programs not attached to an aplet so that they can temporarily 'borrow' abilities belonging to an aplet. However, it could also be used to create an aplet that had two 'parents' if you required it to inherit abilities from both. You could then swap from one parent to the other using this command. This could be quite cumbersome but might add some powerful features.

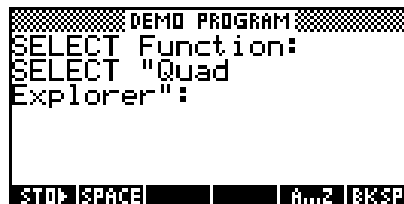

**SETVIEWS <prompt>;<program>;<view number>**

This absolutely critical command is covered in great detail on page 214.

## The Branch commands

**IF <test> THEN <>true clause> [ELSE <>false clause>] END**

Note the need for a double = sign when comparing equalities. Any number of statements can be placed in the true and false sections. Enclosing brackets are not required.

```
DEMO PROGRAM
IF A==5 THEN
6>B:
ELSE
7>B:
END:
STOP SPACE | A...Z BKSP
```

**CASE <if clauses> ...END:**

This command removes the need for nested IF commands but is only worth it if you have more than two or three nested IFs. Note that colons are not required for the ENDS which terminate the internal IF clauses.

```
DEMO PROGRAM
CASE
IF A<=0 THEN 5>B: END
IF A>0 THEN 2>B: END
END:
STOP SPACE | A...Z BKSP
```

**IFFERR <statements> THEN <statements> [ELSE <statements>] END**

This can be used to error trap programs where there is a possibility of something going wrong which would normally crash the program, such as evaluating a function at a point for which it is undefined. By trapping the suspect code you can supply an alternative which will perform some other action. This will tend to make your programs more user friendly and is a very good idea!

```
DEMO PROGRAM
IFFERR F1(X)>A: THEN
MSGBOX"Undef. ":
ELSE
:::code...
END:
STOP SPACE | A...Z BKSP
```

## ***RUN <program name>***

This command runs the program named, with execution resuming in the calling program afterwards. If a particular piece of code is used repeatedly then this can be used to reduce memory use by placing the code in a separate program and calling it from different locations.

See the SETVIEWS command for information on how to link a program to an applet when it does not appear on the primary menu. Note that if the name has spaces in it then it must be enclosed in quotes.

```
DEMO PROGRAM
RUN Small:
RUN "Input value":
STOP SPACE | A...2 BKSP
```

## ***STOP***

This command can be used to abort execution of a program. Control resumes in the HOME view.

```
DEMO PROGRAM
IF A==0 THEN
STOP:
ELSE
... Code...
END:
STOP SPACE | A...2 BKSP
```

## ***The Drawing commands***

### ***ARC <x-center>;<y-center>;<radius>;<start angle>;<end angle>***

This command draws an arc on the screen. It uses the current values in the PLOT SETUP view as the screen coordinates and the settings in the the MODES view for angle format. This command is VERY slow.

```
DEMO PROGRAM
ARC 0;0;3;0;π/2:
STOP SPACE
```

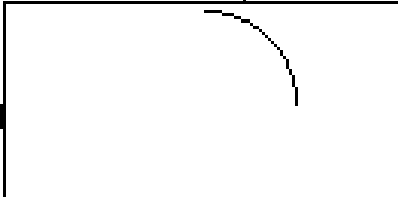

### ***BOX <x1>;<y1>;<x2>;<y2>***

This draws a rectangular box on the screen using (x1,y1) and (x2,y2) as the corners. The coordinates are relative to the settings in the PLOT SETUP view.

```
DEMO PROGRAM
BOX -3;2;1;-1:
STOP SPACE
```

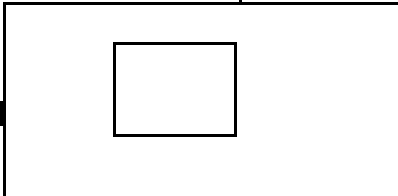

## **ERASE**

This command erases the current display screen.

## **FREEZE**

This command halts execution until the user presses any key.

## **LINE <x1>;<y1>;<x2>;<y2>**

This draws a line on the screen using (x1,y1) and (x2,y2) as the ends. The coordinates are relative to the current settings in the **PLOT SETUP** view.

## **PIXON <x>;<y> and PIXOFF <x>;<y>**

This command turns a pixel point on or off at the specified point. The coordinates are relative to the current settings in the **PLOT SETUP** view.

## **TLINE <x1>;<y1>;<x2>;<y2>**

This command is the same as **LINE** except that the line drawn reverses the current set/unset value of all pixels. It can be used to erase previously drawn lines. One of the applets on *The HP HOME* view (at <http://www.hphomeview.com>) is called "Sine Define" and contains extensive use of this command.

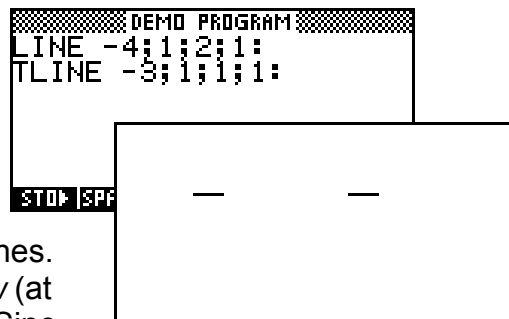

## The Graphics commands

See the chapter “Programming the hp 39g+” on page 226 for examples illustrating some of the graphics commands used regularly.

## The Loop commands

**FOR <variable> = <start value> TO  
<end value> [STEP <increment>] <statements> END**

This is a standard FOR...NEXT command. The STEP value is optional and is assumed to be 1 if not stated. Whatever you do, don't use NEXT to terminate the loop! It doesn't register as an error but all sort of strange things happen!

```
FORNEXT PROGRAM
FOR I=10 TO 50 STEP 5;
  DISP 3;I:
END:
FOR I=10 TO 40;
  DISP 3;I:
END:
STOP SPACE | A...Z | BKSP
```

**DO <statements> UNTIL <test clause> END**

This loop executes the statements within it until the test clause evaluates as true. It must execute at least once. The example right checks for a positive integer from the INPUT statement. To be even more user friendly you could let the user know what they had done wrong by adding another few lines of code within the DO loop of..

```
IF INT(N)≠N OR N≤0 THEN
  MSGBOX "Enter a positive integer only":
END:
```

```
DOUNTIL PROGRAM
DO
  INPUT N;"ITERATE";
  "N:";"Runs?";100:
UNTIL INT(N)==N AND
N>0 END:
STOP SPACE | A...Z | BKSP
```

**WHILE <test clause> REPEAT <statements> END**

This is similar to the DO...UNTIL loop except that the test clause is evaluated before starting so that the loop may not be executed at all.

## ***BREAK***

This command will exit from the current loop, resuming execution after the end of it. There is no GOTO <label> command in the language.

## ***The Matrix commands***

### ***EDITMAT <matrix var>***

This command pops up a window in which the user can edit or input a matrix with an **OK** key at the bottom. When the user presses **OK**, execution resumes after the EDITMAT statement.

### ***REDIM <matrix var>;<size>***

This command is very useful if the size of a matrix is not known in advance. The user might be prompted to input the size and then these values used to resize it. Note that the dimensions must be supplied as a list variable. The SIZE command can also be used in this context as it returns a list variable when used with a matrix.



## ***The Print commands***

These commands are supplied for use with the battery operated HP infra-red thermal printer that is designed for use with the hp 38g, hp 39g, hp 40g and hp 39g+.

### ***PRDISPLAY***

If you place this command in a program then the current display will be sent to the infra-red printer.

### ***PRHISTORY***

This command, whether issued in the **HOME** view or in a program, will send the entire contents of the History to the infra-red printer.

### ***PRVAR <variable>***

This command, whether issued in the **HOME** view or in a program, will send the value of the variable to the infra-red printer. This can be used to capture and send images of graphs without need for programming as follows:

- set up the graph or image as required
- press **ON+PLOT** to capture the image and store it in grob **G0**
- in the **HOME** view, issue the command **PRVAR G0**.

## The Prompt commands

### **BEEP <frequency>;<duration>**

This will use the piezo crystal in the calculator to create a sound of the specified frequency for the specified duration (in seconds). The resulting frequency is not terribly accurate, varying by up to 5% from one calculator to the next and depending also on the temperature.

The frequencies of the twelve semi-tone jumps in the harmonic scale form a geometric sequence, and since the ratio from C to C' is 2, the ratio for each semi-tone must be  $\sqrt[12]{2}$ . The standard frequency used in tuning instruments is usually 440 cycle/sec for the note A. Since much of the simple music used by students is written using the scale of C, I use  $440 / (\sqrt[12]{2})^9$  to find the frequency of C as 261.6 cycles/sec.

We can use this to form a standard 'header' for any program we want to use to play music. The header shown right in the rounded box sets up the scale of C major. The code which then follows plays the first two bars of the tune "Strangers in the Night".

```
.5▶T:
261.6▶C:
12 NTHROOT 2▶R:
R²C▶D:
R²D▶E:
R²E▶F:
R²F▶G:
R²G▶A:
R²A▶B:
```

```
BEEP F; T/2:
BEEP G; T/2:
WAIT .01T:
BEEP G; T/2:
BEEP F; T/2:
BEEP G; 2.5T:
BEEP F; T/2:
BEEP G; T/2:
BEEP A; T/2:
BEEP G; T/2:
BEEP F; 1.5T:
```

In this header, the duration of a note (T) is set to 0.5 seconds. It is easy to change the tempo of the music by adjusting this. In this case you may find that the music sounds a little better with T set to 0.55 or 0.6 seconds. T is a crotchet, T/2 a quaver etc.

### **CHOOSE <variable>;<title>;<menu option1>;....**

This command pops up a menu with the title specified and with however many options follow. The number of the menu option highlighted when the user presses **OK** is returned in the variable. The initial value of the variable before the CHOOSE statement determines which option is initially highlighted.

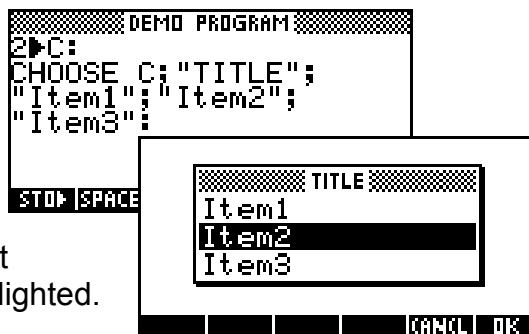



This value must be a valid one. Assigning an initial value outside the range of the menu may crash the program. If the user presses CANCL then a value of zero is returned but the program will still continue to execute from that point unless you include code to terminate it.

**DISP <line number>;<expression>**

This command breaks the display up into 7 lines and allows output to them.

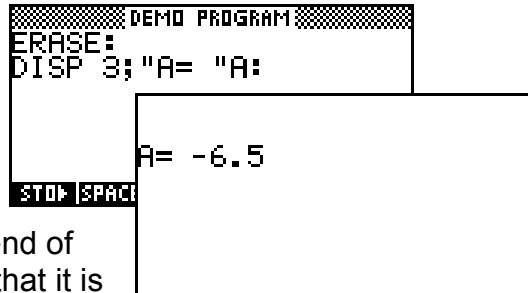

Using the DISP command on a line wipes that entire line to the right hand end of the screen before display. This means that it is not possible to use DISP to 'edit' material already present. The DISPXY command should be used for this purpose.

**DISPXY <xpos>;<ypos>;<font>;<expression>**

This command displays the text/object/result contained in <expression> at the screen position specified using the font specified. An extensive example can be found in the chapter "Programming the hp 39g+" on page 226.

**DISPTIME**

This command pops up a box displaying the calculator's internal time and date. These can be set by storing values to the variables Time and Date. Suppose the current time is 3:46:29 pm on the 1<sup>st</sup> of December, 1998 then you would store 15.4629 to Time and 12.011998 to Date.

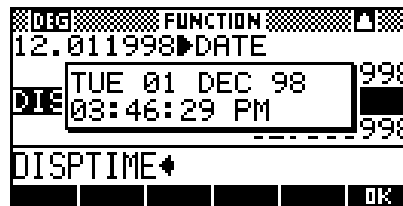

**GETKEY <variable>**

This pauses the execution until the user presses a key and stores the code for the key into the variable for later use. See the manual for how the value of the key changes according to whether it is pressed with or without the SHIFT or ALPHA keys. A key code of 53.1 would mean row 5, column 3 and unshifted. It can't readily be used for games because execution pauses instead of continuing in the background.

**INPUT <variable>;<title>;<prompt>;<message>;<default value>**

This command puts up an input view which can be used to obtain responses from the user. The degree of control over appearance is quite high as can be seen in the example.

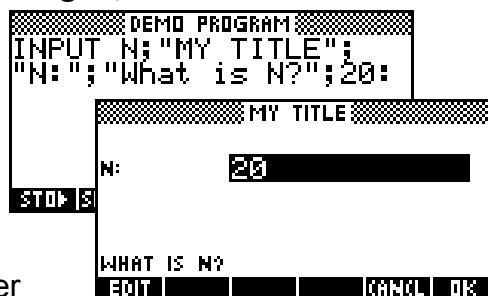

If you want the default value to be whatever the user last input then use INPUT N;.....;N instead. If you do this then you will need to store and initial reasonable value into N before the first use of the INPUT command.

**MSGBOX <expression>**

This puts up a box with the text/expression you specify. If you want a newline character then just enclose a pressing of the ENTER key within the quotes.



**PROMPT <variable>**

This is a short form of the INPUT statement for those that don't require such precision of control over appearance. The default value is the current value of the variable.

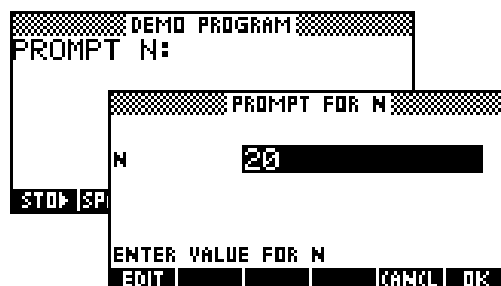

**WAIT <duration>**

This command pauses execution for the specified number of seconds.



**Calculator Tip**  
This list does not cover anywhere near the full range of commands, but it does cover enough that a competent programmer will be able to work out the rest independently. It is also enough that an enthusiastic amateur will be able to accomplish the more common tasks required in programming the hp 39g+.

## THE MATH MENU FUNCTIONS

The **MATH** menu is accessed via the key below the **APLET** key. Any time that you are typing a value into any formula or setup screen you can insert mathematical functions via the **MATH** key.

The **MATH** menu is divided up into sections by mathematical topics. These topics are:

<a href="#">Real</a>	- rounding, roots, conversions and % functions.
<a href="#">Stat-Two</a>	- bivariate functions.
<a href="#">Symbolic</a>	- functions for manipulating equations and symbols.
<a href="#">Tests</a>	- used in programming more than normal work.
<a href="#">Trig</a>	- sec, cosec etc.
<a href="#">Calculus</a>	- integration and differentiation
<a href="#">Complex</a>	- functions to manipulate complex numbers.
<a href="#">Constants</a>	- e, i and various others. Of more use in programming.
<a href="#">Hyperb.</a>	- the hyperbolic trig functions.
<a href="#">List</a>	- functions allowing manipulation and creation of lists of numbers, including columns of stats data.
<a href="#">Loop</a>	- iterative functions.
<a href="#">Matrix</a>	- a rich collection of functions to manipulate matrices.
<a href="#">Polynom.</a>	- another rich collection, this time to manipulate polynomials.
<a href="#">Prob.</a>	- functions used in probability calculations.

Some of these functions have little application at school level and will not be covered here. Others will be covered to varying depths. Anyone needing those not covered will find that after reading this manual they can be relatively easily deciphered from the manual that comes with the calculator.

The mechanics of accessing the **MATH** menu is very simple. We will illustrate the process using the Polynomial function **POLYFORM**, which is an extremely useful one. Change into the **HOME** view and then press the **MATH** key.

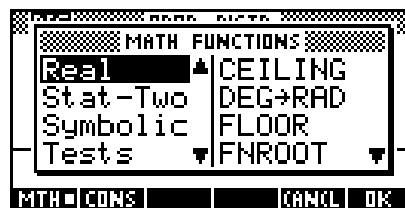

When you do you will see the screen on the right. The menu always first appears with the Real functions highlighted.

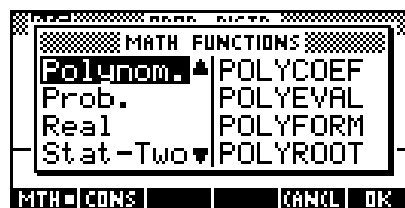

We could use the arrow keys to scroll down to the Polynomial functions but it is far faster to simply press the key labeled with the letter 'P' (on the '5' key). It is not necessary to press the **ALPHA** key first. You will notice in the screen on the right that there are two groups of functions beginning with a 'P' - being Polynomial and Probability. To reach Probability press the 'P' key again.

Once you are in the correct group, press the right arrow key to move into the list of functions belonging to that group. Once again you have a choice of using the arrow keys or the key corresponding to the first letter of the function. Pressing the right arrow key again will move down the functions a 'page' at a time. In this case, since every single function in the Polynomial group begins with a 'P', and there is only one 'page' of them, there is no difference between the methods. Move the highlight down to **POLYFORM** and then press the **ENTER** key.

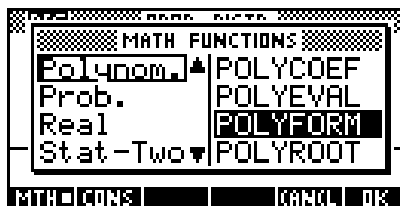

Your **HOME** view should now look like this. You will notice that the first bracket has already been inserted for you.

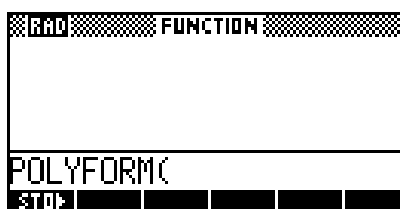

Complete the expression...

$$\text{POLYFORM}((X+2)^5 - (3X-1)^2, X) \quad (\text{using } X^Y \text{ key to get } ^)$$

and then press the **ENTER** key.

You will find that the expression  $(x+2)^5 - (3x-1)^2$  has been expanded on the following line to  $x^5+10*x^4+40*x^3+71*x^2+86$ ...

There are two ways of seeing the complete result.

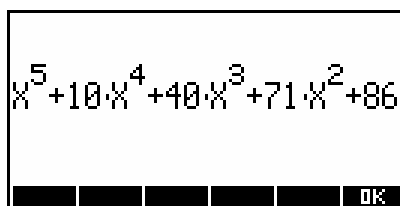

You can move the highlight up to that line and **COPY** it. You could then move back and forth through the line using the arrow keys to see it in full.

A better method is to press the screen key labeled **SHOW**. This gives (after a pause) the result shown above. The portion off the edge of the screen can be seen by scrolling right using the arrow key. More details will be given of this **POLYFORM** function in the *Polynomial* group when we get to it.

On the pages which follow we will look at most of the functions in each group. Some of the functions are not likely to be used at school level and so will not be covered since this book is primarily aimed at teachers and students of high school, as is the hp 39g+. If you need the higher level commands then consult the manual.

You can obtain 'help' for any function in the **HOME** view by using the **SYNTAX** key to obtain the word **HELPPWITH** and then typing the function name. An example is shown right for the **DISPXY** command. Thus this is saying that you have to type x and y coordinates, followed by a font number and the item or items to be displayed.

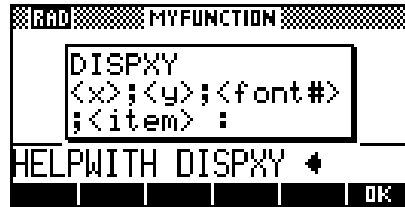

There is a limit to how much this **HELPPWITH** statement will aid a normal user of the calculator, since these syntax statements are usually more suited to a programmer type than to a student.

One piece of terminology that will be used in this section of the manual is 'argument'. The arguments of a function are the pieces of information it is expecting you to feed it before it will give you an answer. These might be numbers, variable names, lists, matrices or algebraic expressions.

The calculator will not guess what you mean. If you don't feed it the information it requires then it will simply give you an error message.

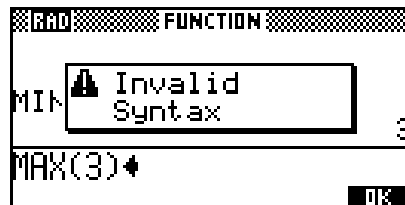

For example, the function **MAX** expects two arguments, both of them numbers. Feeding it only one (or more than two) will produce the result shown right.



These numbers could also be the contents of memories. Suppose you have stored 10 in memory A and 15 in B. Then **MAX(A,B)** will give 15.

Finally, if you look at the screenshot at the top of the previous page you will see that is another set of menus available via the **CONS** key, which stands for *Constants*. Pressing this key result in a different menu being displayed, which shows the 'Program Constants'. You can try it if you like but the values listed in these menus are generally only of use to programmers.

## The 'Real' group of functions

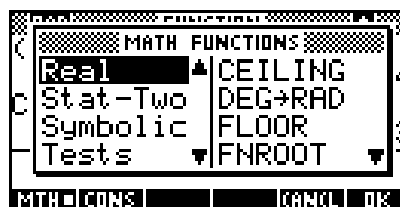

### CEILING(<num>)

This is a 'rounding' function but different in that it always rounds up to the integer above. Mainly of interest to programmers.

Eg.  $\text{CEILING}(3.2) = 4$   
 $\text{CEILING}(32.99) = 33$   
 $\text{CEILING}((12+\sqrt{6})/7)$   
 $= \text{CEILING}(2.0642\dots) = 3$

Note:  $\text{CEILING}(-2.56) = -2$  not  $-3$ . The CEILING function rounds up to the next integer above, which is  $-2$ .

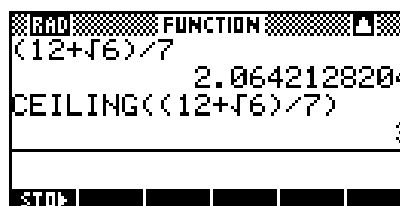

See also: [ROUND](#), [TRUNCATE](#), [FLOOR](#), [INT](#)

### DEG→RAD(<deg>)

This function converts degrees to radians.

Eg.  $\text{DEG}\rightarrow\text{RAD}(30) = 0.5235\dots$   
 $\text{DEG}\rightarrow\text{RAD}(180) = 3.1415926\dots$

See also: [RAD→DEG](#), [HMS→](#), [→HMS](#)

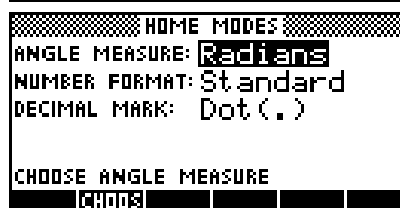
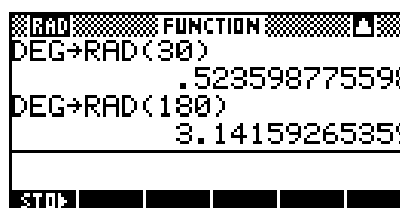

### FLOOR(num)

This function is the same as the [CEILING](#) function, except that it always rounds down.

Eg.  $\text{FLOOR}(3.75) = 3$   
 $\text{FLOOR}(45.01) = 45$

Note:  $\text{FLOOR}(-2.56) = -3$  not  $-2$ .

The FLOOR function is the same as the mathematical function 'greatest integer' which is studied in many mathematical courses.

If you want to graph the greatest integer function then you will need to use the **PLOT SETUP** view to turn off **CONNECT** first, since the graph is supposed to be a discontinuous step function. The result with **CONNECT** turned on is not good.

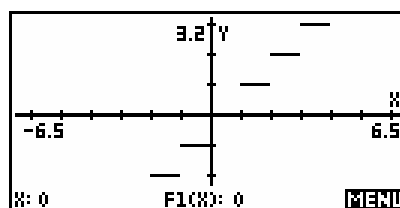
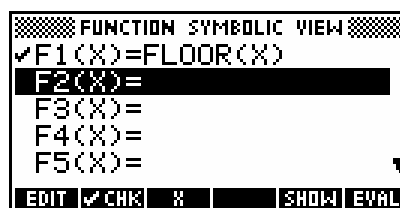

### ***FNROOT(express.,guess)***

This function is like a mini version of the Solve aplet. If you feed it an algebraic expression and an initial guess it will start from your guess and find the value which makes the expression zero. Don't bother. It's a lot easier to use the Solve aplet. This is a tool for programmers so that they can access the Solve abilities within programs.

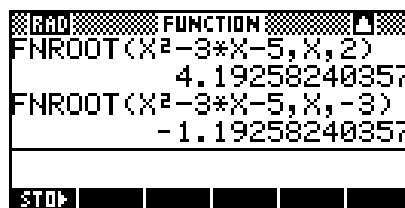

You need to tell it what variable to expect in the expression, in addition to providing it with an initial guess. If there is only one answer then any guess will do, but if more than one solution is possible then more care needs to be taken with your guess to ensure that it is in the neighborhood of your desired solution.

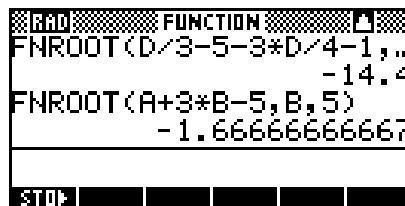

- Eg. (a) Solve  $x^2 - 3x - 5 = 0$   
Use: `FNROOT(X^2-3X-5,X,2)`
- (b) Solve  $\frac{d}{3} - 5 = \frac{3d}{4} + 1$   
Use: `FNROOT(D/3-5-3D/4-1,D,0)`

As with Solve, if your expression involves more than one variable then whatever values are currently in memory are used for the other variables.

See also: [QUAD](#), [POLYROOT](#)

### ***FRAC(num)***

This function gives the decimal part of any number, discarding the integer part.

- Eg. `FRAC(3.45) = 0.45`  
`FRAC(1234.03456) = 0.03456`

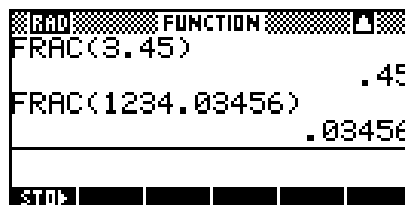

See also: [INT](#), [FLOOR](#), [CEILING](#), [ROUND](#), [TRUNCATE](#), [FRAC](#)

### **HMS→ (dd.mmss)**

This function works with time and angles. It converts degrees, minutes and seconds to degrees, and also hours, minutes and seconds to decimal time.

The calculator can convert a value such as  $45^{\circ}23'17''$  if you put it into the form 45.2317 and then use the HMS→ function.

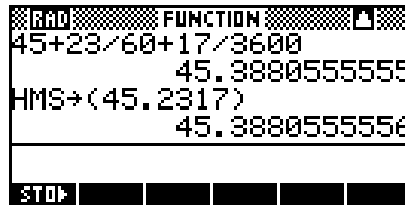

Eg.  $\sin(45^{\circ}23'17'')$  would be done as  $SIN(HMS\rightarrow(45.2317))$   
 $\cos(5^{\circ}3'7'')$  would be done as  $COS(HMS\rightarrow(5.0307))$

This function, together with →HMS, can also be used to deal with time.

Eg. What time will it be 1 hr 34 min. and 15 sec. after 3 min. past 6 pm?  
Type:  $HMS\rightarrow(18.03)+HMS\rightarrow(1.3415)$   
Ans: 37 min. 15 sec. past 7 pm. (see right)

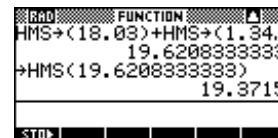

See also: [→HMS](#), [RAD→DEG](#), [DEG→RAD](#)

### **→HMS(num)**

This function works in the same way as the HMS→ function but in the opposite direction. It converts decimal degrees (or time) to degrees (or hours), minutes and seconds. The format of the returned answer is DD.MMSS (HH.MMSS)

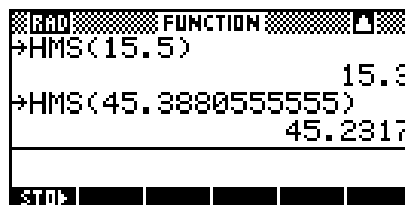

Eg.  $15.5^{\circ}$  would become  $15.3$ , meaning  $15^{\circ}30'$ .  
 $45.38805555 \rightarrow 45.2317$  ( $45^{\circ}23'17''$ )  
 $3.75$  hours  $\rightarrow 3.45$  (3 hours 45 min.)

See also: [HMS→](#), [RAD→DEG](#), [DEG→RAD](#)



### ***INT(num)***

This function is related to the FLOOR and CEILING functions. Unlike those two, which consistently move down or up respectively, the INT function simply drops the fractional part of the number.

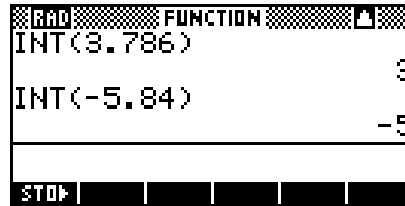

Eg.  $\text{INT}(3.786) = 3$   
 $\text{INT}(-5.84) = -5$

See also: [FLOOR](#), [CEILING](#), [ROUND](#), [TRUNCATE](#), [FRAC](#)

### ***MANT(num)***

This function returns the mantissa (numerical part) of the number you feed it when transformed into scientific notation. It would be used with the XPON function, which returns the power part of the number in scientific notation.



Eg. Change  $487.23$  into scientific notation to get  $4.8723 \times 10^2$ .  
 $\text{MANT}(487.23) = 4.8723$   
 $\text{XPON}(487.23) = 2$

Change  $0.0005087$  into scientific notation to get  $5.087 \times 10^{-4}$ .  
 $\text{MANT}(0.0005087) = 5.087$   
 $\text{XPON}(0.0005087) = -4$

See also: [XPON](#)

### ***MAX(num1,num2)***

This function returns the larger of two values entered. This is not needed in your normal calculations, since you could just look at the numbers, but a programmer will be writing a program which deals with numbers not known in advance.

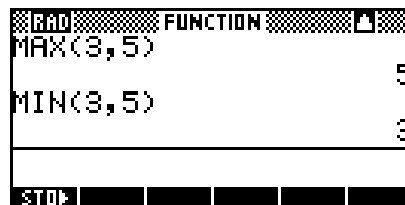

Eg.  $\text{MAX}(3, 5) = 5$

See also: [MIN](#)

### ***MIN(num1,num2)***

As with MAX, this function is used mainly by programmers. It returns the smaller of the two numbers entered.

Eg.  $\text{MIN}(3,5) = 3$

See also: [MAX](#)

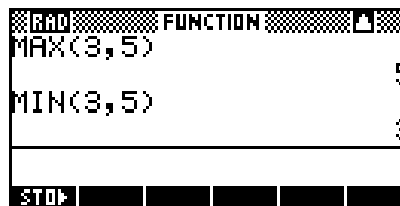

### ***num MOD divisor***

For those not familiar with modulo arithmetic, it will suffice to say that this function gives you the remainder when one number is divided by another. It is considered to be an mathematical operator in the same way that a plus, minus, times or divide sign is. Because of this it does not need its arguments placed in brackets as most of the other functions in the MATH menu do.

Eg.  $43 + 5 = 48$   
 $43 \text{ MOD } 5 = 3$   
 $35 \text{ MOD } 7 = 0$   
 $-14 \text{ MOD } 5 = 1$

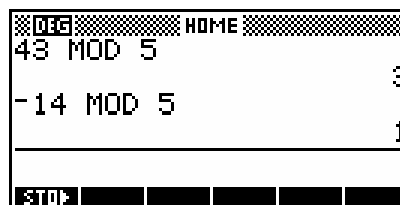

### ***% function***

To find x% of y, use the function  $\%(X, Y)$ .

Eg.  $10 \% \text{ of } \$400 = \$40$

See also: [%](#), [%TOTAL](#), [%CHANGE](#)



## **%CHANGE**

This function calculates the percentage change moving from X to Y using the formula  $100(Y-X)/X$ . It can be used to calculate (for example) percentage profit and loss.

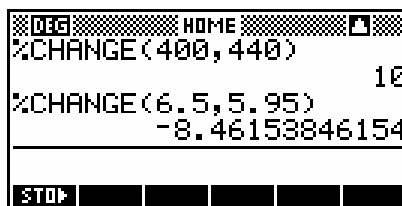

Eg. I buy a fridge for \$400 and sell it for \$440.  
What is my profit as a percentage?  
Use: %CHANGE(400,440)

I sell a toy for \$5.95 that normally sells for \$6.50  
What is the discount as a percentage?  
Use: %CHANGE(6.50,5.95)

See also: [%](#), [%TOTAL](#)

## **%TOTAL**

To find out what percentage X is of Y, use the function %TOTAL(Y,X). Note the reversed order.

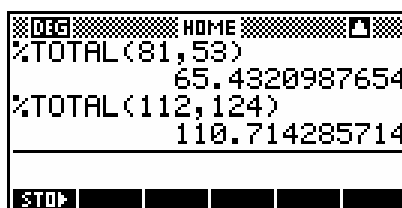

Eg. What percentage is a score of 53 out of 81 on a test?  
Use: %TOTAL(81,53)

What percentage is 124 of 112?  
Use: % TOTAL(112,124)

See also: [%](#), [%CHANGE](#)

## **RAD→DEG(rad)**

This function converts radians to degrees.

Eg.  $\text{RAD} \rightarrow \text{DEG}(\pi/6) = 30^\circ$   
 $\text{RAD} \rightarrow \text{DEG}(5) = 286.48^\circ$

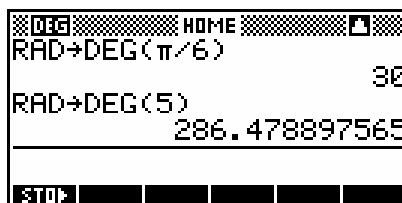

See also: [DEG→RAD](#), [HMS→](#), [→HMS](#)

## ***ROUND(num,dec.pts)***

This function rounds off a supplied number to the specified number of decimal places (d.p.).

Eg. Round 66.65 to 1 d.p.  
Use:  $\text{ROUND}(66.65,1)=66.7$

Round 34.56784 to 2 d.p.  
Use:  $\text{ROUND}(34.56784,2)=34.57$

This function is also capable of rounding off to a specified number of significant figures (s.f.). To do this, simply put a negative sign on the second argument.

Round 32345 to the nearest thousand.  
Use:  $\text{ROUND}(32345,-2) = 32000$

Round 3405.63475 to 6 s.f.  
Use:  $\text{ROUND}(3405.63475,-6) = 3405.63$

See also: [INT](#), [FLOOR](#), [CEILING](#), [TRUNCATE](#), [FRAC](#)

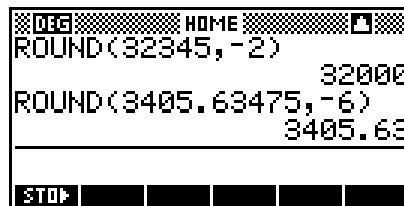
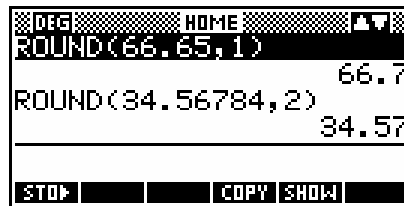

## ***SIGN(num)***

Another function designed more for programmers, returning a value of +1, 0 or -1 depending on whether the number supplied is positive, zero or negative.

Eg.  $\text{SIGN}(-45) = -1$

See also: [XPON](#), [MANT](#)

**Note:** See also SIGN in the Complex group of functions (page 263).

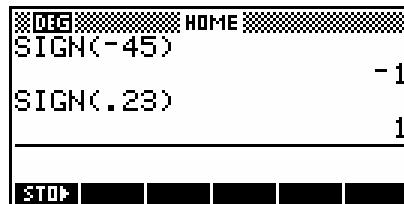

## **TRUNCATE(num)**

This function operates similarly to the ROUND function, but simply drops the extra digits instead of rounding up or down. It is somewhat similar in effect to the FLOOR function but the TRUNCATE function will work to any number of decimal places or significant figures instead of always dropping to the nearest lower integer value.

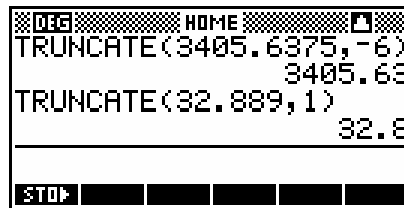

Eg.  $\text{TRUNCATE}(3405.6375, -6) = 3405.63$

$\text{TRUNCATE}(32.889, 1) = 32.8$

See also: [INT](#), [FLOOR](#), [CEILING](#), [ROUND](#), [FRAC](#)

## **XPON(num)**

This function returns the exponent (indicial part) when transformed into scientific notation of the number you feed it. It would be used with the XPON function, which returns the power part of the number when in scientific notation.

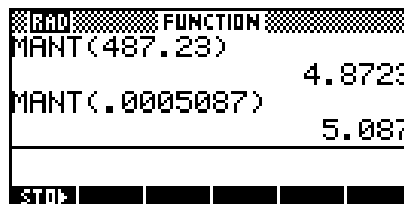

Eg. Change  $487.23$  into scientific notation to get  $4.8723 \times 10^2$ .

$\text{MANT}(487.23) = 4.8723$

$\text{XPON}(487.23) = 2$

Change  $0.0005087$  into scientific notation to get  $5.087 \times 10^{-4}$ .

$\text{MANT}(0.0005087) = 5.087$   $\text{XPON}(0.0005087) = -4$

This function could be of use to you if you are just learning scientific notation, but is of more use to people writing programs. A normal user would just look at the number and see the answer, but a programmer would not know in advance what number was going to be used and so might use MANT and XPON.

See also: [MANT](#)

## The 'Stat-Two' group of functions

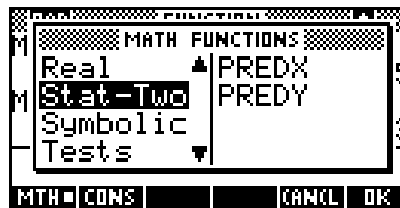

### **PREDY(x-val)**

This function predicts the  $y$  value for a pair of columns set up as bivariate data in the Statistics applet. This is discussed in more detail in the section covering the Statistics applet, but a brief summary will be given here.

It assumes that:

- (i) the bivariate data is entered into a pair of columns (eg. C1 and C2, with C1 containing the independent data and C2 the dependent data),
- and (ii) that these two columns have been specified in the **SYMB** view to be paired bivariate data,
- and (iii) that this data set has been graphed in the **PLOT** view and that the **FIT** screen key has been used to plot the line of best fit for the pair of columns,

If these conditions are satisfied then the function  $PREDY(3.5)$  will produce a predicted  $y$  (dependent) value for the  $x$  (indep.) value of 3.5.

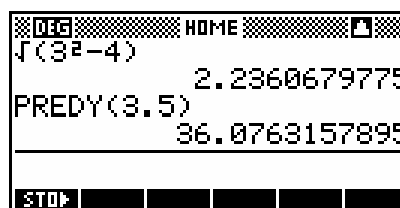

#### **Calculator Tip**

The line of best fit used in the function  $PREDY$  is whichever one was last plotted. *It is up to you* to ensure that this is in fact the one you want used! It is far easier and more reliable to use the facilities provided in the **PLOT** view (see page 140) to calculate  $PREDY$  values.

### **PREDX(y-val)**

The  $PREDX$  function simply reverses the line of best fit. For example, the equation  $\hat{Y} = 0.8199X + 1.1662$  earlier would use  $\hat{X} = \frac{(Y - 1.1662)}{0.8199}$  to predict the  $X$  values.

**Note:** See page 146 for important information on this function.

## The 'Symbolic' group of functions

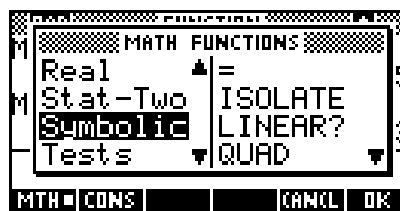

### The = 'function'

Although this is listed in the **MATH** menu as if it were a function, it is not really. Except in programming, the = sign is simply used in exactly the way that you would expect it to be, mainly in the Solve aplet. It's easier to obtain the = sign directly from the keyboard.

### ISOLATE(expression, var-name)

This function will rearrange a formula so that its subject is another variable. To do this, the formula must be rewritten so that it is an expression which equals zero. The **ISOLATE** function then rearranges the formula in terms of that variable.

Eg. 1 Rewrite the formula  $d = \frac{1}{2}at^2$  in 't'.

Firstly, rewrite as:  $d - \frac{1}{2}at^2 = 0$

Use: **ISOLATE**(D-AT<sup>2</sup>/2, T)



The result needs interpretation as the answer should be  $T = \pm \sqrt{\frac{2D}{A}}$ . Firstly, the 'T=' is missing and secondly, the symbol 'S1' stands for the  $\pm$  sign.

Eg. 2 Make x the subject of the formula  $B = \frac{-3}{(X-A)}$ .

Using: **ISOLATE**(3/(X-A)+B, X)  
gives:  $3/-B+A$

equivalent to:  $X = \frac{-3}{B} + A$ .



The **ISOLATE** function is very useful within its limitations, but it will not deal with a lot of formulae. See right:

See also: [The Solve aplet](#), [FNROOT](#), [QUAD](#)

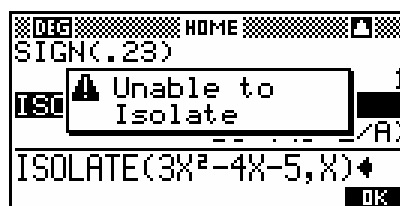

### **LINEAR?(expression,var.name)**

This is another of those functions which is probably aimed more at the programmer than at the normal user. It is designed to test whether a supplied expression is linear or non-linear in the variable you specify, returning zero for non-linear and 1 for linear.

Eg. Suppose we use the expression  $AX^2 - B + 4$

If X is the variable and A and B are both constants (say A=4, B=5) then the expression  $AX^2 - B + 4$  would become  $4X^2 - 5 + 4$  which would be non-linear. Thus LINEAR? returns zero (right).

```
HOME
ISOLATE(3/(X-A)+B,X)
3/-B+A
LINEAR?(A*X^2-B+4,X)
0
STO>
```

On the other hand, if X were one of the constants (say X=6) and A were the variable, then the expression  $AX^2 - B + 4$  would become  $A \times 6^2 - 5 + 4$  or  $36A - 1$ , which is linear. Thus LINEAR? would return 1.

```
HOME
LINEAR?(A*X^2-B+4,X)
0
LINEAR?(A*X^2-B+4,A)
1
STO>
```

The main use for this is going to be when a programmer does not know in advance what function the user is going to type in.

### **QUAD(expression,var.name)**

This function uses the quadratic formula

$$x = \frac{-b \pm \sqrt{b^2 - 4ac}}{2a}$$

to give both roots of a quadratic, using the 'S1' formal variable to represent the  $\pm$  symbol. The quadratic is

entered as an expression, and you must indicate which variable is being solved for, since you could have an equation such as  $Px^2 + Qx - 5 = 0$  where P and Q were memory values, and you would need to specify to solve for X.

```
HOME
QUAD(X^2-4*X-5,X)
(4+/-1*6)/2
QUAD(3*X^2+2*X-9,X)
(-2+/-1*10.5830052443)...
STO>
```



Eg. Solve  $x^2 - 4x - 5 = 0$   
 Use QUAD( $X^2 - 4X - 5, X$ )  
 Answer:  $(4 + S1 * 6) / 2$

$$x = \frac{4 \pm 6}{2}$$

$$= \frac{4 + 6}{2} \quad \text{or} \quad \frac{4 - 6}{2}$$

$$= 5 \quad \text{or} \quad -1$$

It is now up to you to interpret this algebraically as:

If you are simply after the roots of the quadratic then it is far better to use the **POLYROOT** function (page 284). If you would like a solution such as  $\frac{3 + \sqrt{5}}{2}$  rather than 2.6180 then the advantage of **QUAD** is that you can **COPY** the result, edit the line to remove all but the decimal root and square it to find the original discriminant.

The **QUAD** function does have one advantage over other methods, in that it will give a complex number solution to quadratics which have complex roots. This may well make it worth using in problems where a complex answer is acceptable or required. Complex numbers are expressed on the hp 39g+ in the form (a, b) representing  $a + bi$ . Thus the answer to the

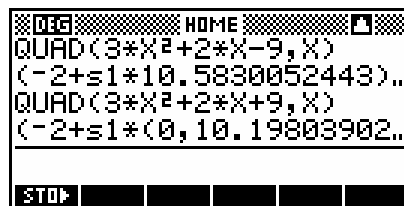

second quadratic shown above would represent  $\frac{-2 \pm \sqrt{-112}}{6}$  with the  $\sqrt{-112}$  written as a complex number.

See also: [FNROOT](#), [LINEAR?](#)

### **QUOTE(var.name)**

Intended for use mainly by programmers. Programmers sometimes want to store a function such as  $X^2 - 4$  into one of F1(X)...F9(X) using **STO**. It turns out that if you use F1( $X^2 - 4$ ) then it won't be entered symbolically. Instead, the contents of X (a number) is entered substituted and the expression evaluated to give a numeric result. The **QUOTE** function fixes this. For example, **QUOTE(X)<sup>2</sup> - 4** F1(X) will ensure a symbolic result.

An easier method of storing a function into an aplet in a program is to enclose it in single quotes. For example ' $(X)^2 - 4$ ' F1(X) would serve the same purpose as **QUOTE(X)<sup>2</sup> - 4** F1(X). On the other hand, entering F1('X') will not work but F1(QUOTE(X)) will. See Example 1 on page 217 in the chapter "Programming on the hp 39g+" for an example of use.

**The | function written as: expression | (var1=value,var2=value,...)**

This is called the 'where' function. The reason for this is that it is used to evaluate formulas, of the type when one would say "Evaluate ....., where a = 5, b = 4 etc". The formula must be in the form of an expression rather than an equation. You should enter the equation first, then the 'where' symbol and then the values of all the variables in the expression. Any not supplied will be evaluated using the value currently stored in that memory. This is again a function which is of more use to programmers since this is probably more flexibly handled in the Solve aplet.

Eg. 1 Evaluate  $a = \frac{b+c}{d}$  where b = 6, c = -2 and d = 8

Use: (B+C)/D | (B=6,C=-2,D=8)  
Answer: 0.5

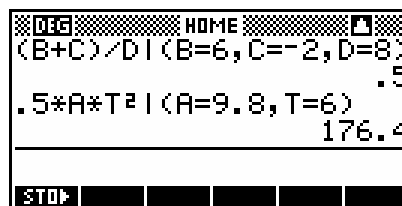

Eg. 2 Using the formula  $d = \frac{1}{2}at^2$ , find the distance d which an object would fall under Earth's gravity of 9.8 m/s<sup>2</sup> in a time of 6 seconds.

Use: .5AT<sup>2</sup> | (A=9.8,T=6)  
Answer: 176.4 meters

See also: [ISOLATE](#)

## The 'Tests' group of functions

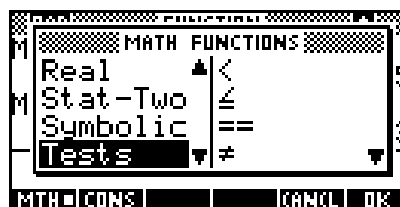

These are all functions which are of interest only to programmers, and consequently we will not cover them here.

An introduction to programming on the hp 39g+ is covered in an earlier chapter (see page 212) but those wanting more detail than is given there must consult the manual. If you want more information then download applets from the internet and dismantle them.

## The 'Trigonometric' & 'Hyperbolic' groups of functions

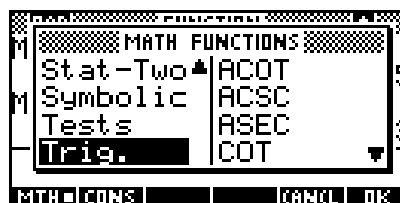

These two groups of functions cover the Trigonometry functions, plus others, which are less commonly used and which have consequently not been given their own keys on the face of the calculator. Use them in the same way as the normal SIN, COS and TAN functions.

### ***COT, SEC etc***

In the Trig. group of functions you will find:

#### Function

COT (cotangent)  
CSC (cosec/cosecant)  
SEC (secant)

#### Inverse function

ACOT (arc-cotangent)  
ACSC (arc-cosec)  
ASEC (arc-secant)

In the Hyperb. group of functions you will find (amongst other things):

#### Function

SINH (hyperbolic sine or "shine")  
COSH (hyperbolic cos or "cosh")  
TANH (hyperbolic tan)

#### Inverse function

ASINH (arc-hyp.sine)  
ACOSH (arc-hyp.cos)  
ATANH (arc-hyp.tan)

Some further functions are available in the Hyperbolic group of functions. They are duplicates of functions available on the face of the calculator but give more accurate answers. They would primarily be of use to those people, such as architects and engineers, for whom high accuracy is paramount. These are:

### **EXP(num)**

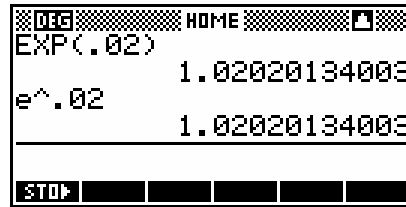

This function gives a more accurate answer than the key labeled  $e^{\wedge}$  which appears above the LN key on the calculator. As you can see on the right, the difference is normally not detectable even to 12 significant figures.

The difference is only apparent for some values and even then is hardly earth-shattering.

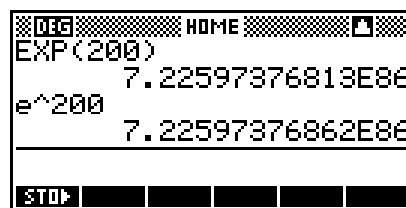

### **ALOG(num)**

This function provides the same result as the key labeled  $10^{\wedge}$  on the keyboard above the LOG key. It is another function giving greater accuracy than the one it 'replaces'. This greater accuracy would never be required in a school setting.

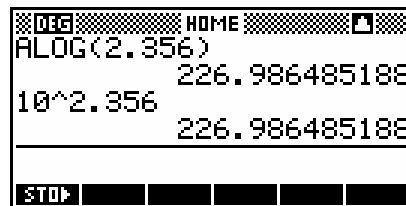

### **EXPM1(num)**

This function is designed to be more accurate when anti-logging very small values close to zero. It gives the value not of  $e^x$  but of  $e^x - 1$  (*EXPM1: exp minus 1*). You may wonder how this is an advantage, since you must then add 1 to obtain the correct answer, but a look at the screen opposite will show you.

As you can see, the normal keyboard function  $e^{\wedge}$  gives an answer to  $e^{0.0000003}$  of 1.0000003. This gives the impression that it is an exact value (since it doesn't show a full 12 significant digits). The true answer is 1.000000300000045.... but the final digits have been lost in the rounding off to 12 sig. figures. By giving an answer of  $e^x - 1$ , the leading 1 is lost, freeing the calculator to show more accuracy by dropping the leading six zeros. This is not normally be needed.

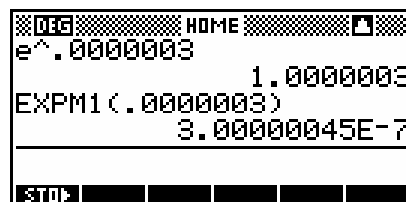

## LNP1(num)

Since the  $\ln(x)$  function is asymptotic to the y axis as  $x$  approaches zero, the natural logs of numbers close to zero are very large negatives, and possibly inaccurate. The function *LNP1* ("ln plus 1"). By finding the natural log of  $x+1$  rather than of  $x$ , the function becomes able to do its calculations in a domain in which greater accuracy is possible. This is not something which would normally be of concern at school level.

### The 'Calculus' group of functions

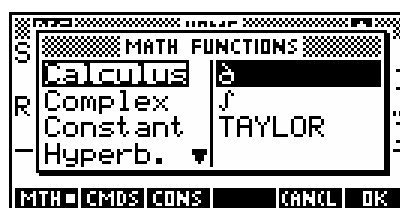

This group consists of three functions, the first two of which are discussed in detail in the chapter dealing with the Function applet (see pages 65 to 83). The functions are the integrate, or  $\int$  function, the differentiate, or  $\frac{d}{dx}$  function, and the TAYLOR function, discussed below.

Briefly, a Taylor polynomial allows you to approximate the graph (and hence values) of a complicated function via a simpler polynomial function. For example,  $\text{SIN}(X)$  can be approximated by taking terms from the polynomial:

$$\begin{aligned}\sin(x) &= x - \frac{x^3}{3!} + \frac{x^5}{5!} - \frac{x^7}{7!} + \dots \\ &= x - \frac{1}{6}x^3 + \frac{1}{120}x^5 - \frac{1}{5040}x^7 + \dots\end{aligned}$$

The screen shot on the right shows the calculator deriving the Taylor polynomial for  $\sin(x)$  up to the 7<sup>th</sup> power.



The first is calculated with **MODES** set to Standard, the second with **MODES** set to Fraction 4. The screen shot below shows the fractional polynomial in more detail after highlighting it and pressing **SHOW**.

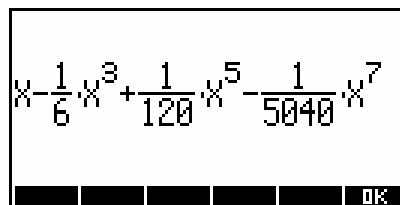

## The 'Complex' group of functions

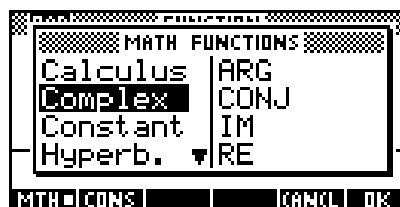

Complex numbers on the hp 39g+ can be entered in either of two ways. Firstly, in the same way as they are commonly written in mathematical workings:  $a + bi$ . Secondly, as an ordered pair:  $(a,b)$ .

For example,  $3+2i$  could be entered into the calculator exactly as it is written, with the 'i' obtained using the ALPHA key, pressing the SHIFT key first to get a lowercase *i*. Alternatively you can enter it directly as an ordered pair.



As soon as you press ENTER, the calculator immediately converts the  $a + bi$  form into an ordered pair. The History retains the original in case you need to COPY it later for re-use.

The exception is when you enter a complex number in rcis form using the  $\sphericalangle$  (angle) sign on the keyboard. When you do this the calculator converts to a more explicit rcis format as shown right. Try it.

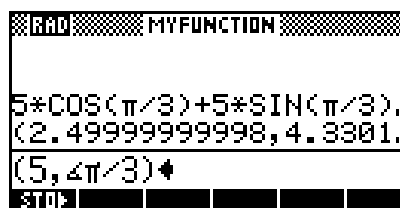

Complex numbers can be used with all trigonometric and hyperbolic function, as well as with matrices, lists and some real-number and keyboard functions.

Just as real numbers can be stored into the alphabetic memories A to Z, there are 10 special memories Z1, Z2 . . . Z9, Z0 which are provided to store complex numbers.



In addition to the trig functions, there are other functions that take complex arguments.

### ***ABS(real or complex)***

The absolute function, which is found on the keyboard above the **-X** key, returns the absolute value of a real number.

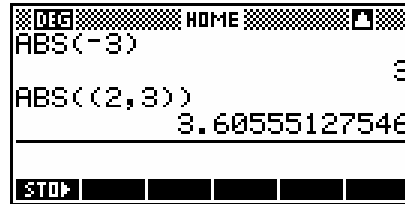

Eg.  $ABS(-3)$  returns a value of 3.

When you use the absolute function on a complex number  $a + bi$  it returns the magnitude of the complex number  $\sqrt{a^2 + b^2}$ .

### ***SIGN(real or complex)***

This function is part of the Real group but is very useful with complex numbers and so is also covered here. If given a vector/complex number  $(a,b)$ , **SIGN** will return another vector/complex number which is a unit vector in the direction of  $(a, b)$ .

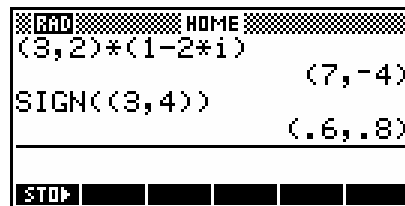

i.e.  $SIGN((A,B))$  returns  $\left( \frac{a}{\sqrt{a^2 + b^2}}, \frac{b}{\sqrt{a^2 + b^2}} \right)$

This is very useful, not just in complex numbers, but also in vector problems.

See also: [SIGN](#) (in the Real group), [IM](#), [RE](#), [ARG](#), [CONJ](#)

### ARG(complex or vector)

This function, also found on the keyboard, returns the size of the angle defined by regarding the complex number as a vector. For example ARG(4+2i) would be 26.565°. The same information can, of course, be obtained using trig.

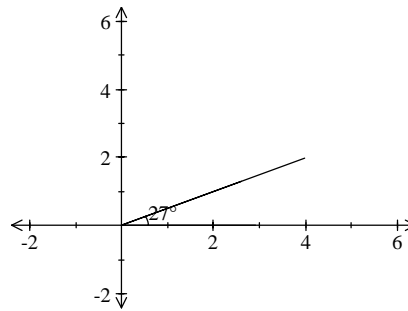

The reason for the double brackets is that every function used by the calculator uses brackets (hence the outer pair) but so too do complex numbers (hence the inner pair). Using ARG(a+bi) instead avoids this.

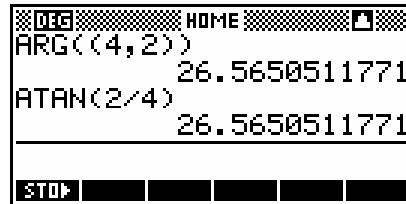

### CONJ(complex)

This function returns the complex conjugate.

Eg. If  $z = 2 + 3i$ , then find the complex conjugate  $\bar{z}$ .

Answer (see right):  $\bar{z} = 2 - 3i$

See also: [IM](#), [ARG](#), [RE](#)

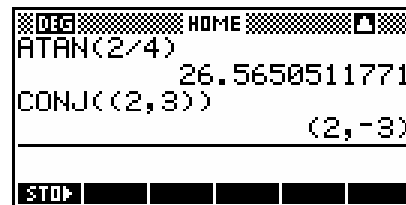

### IM(complex) & RE(complex)

These functions return the imaginary and real parts of the complex number supplied.

See also: [CONJ](#), [ARG](#), [RE](#)

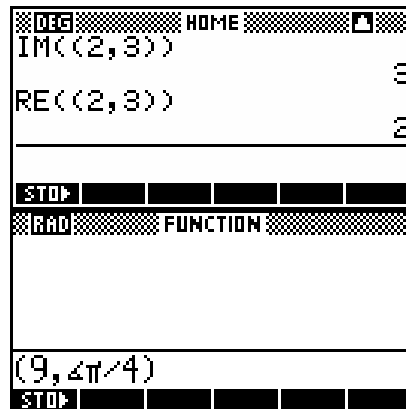

**Note:** As mentioned earlier, a very useful function ( $\angle$ ) can be found on the keyboard as the SHIFT function for 'subtract'. If you enter a complex number in (r,  $\theta$ ) form as shown right, then the calculator will display it in the form  $r\cos(\theta) + r\sin(\theta)$  from, and as an (a,b) ordered pair. Note the  $r\cos(\theta) + r\sin(\theta)$  form is used only when in radian mode.

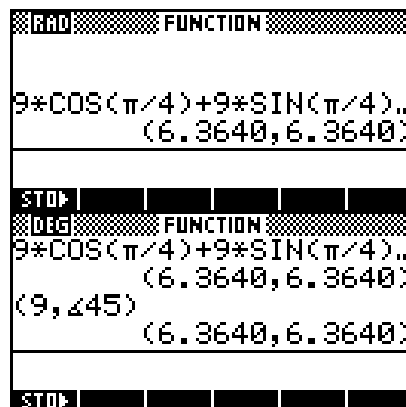



## The 'Constant' group of functions

These 'functions' consist of a set of commonly occurring constants.

Two of them, MAXREAL and MINREAL are mainly of use to programmers except for an important influence on the evaluation of limits (see page 88). They consist, respectively, of the largest and smallest numbers with which the calculator is capable of dealing, and are there for use by programmers as a check to ensure that calculations within a program have not overflowed the capacity of the calculator.

The other three,  $\pi$ ,  $i$ , and  $e$ , are far more easily obtained via the keyboard.

The first,  $\pi$ , is available via a key on the face of the calculator above the 3 key. The other two,  $i$  &  $e$ , are easily obtained as lowercase letters via the ALPHA key, pressing SHIFT first to get lowercase.

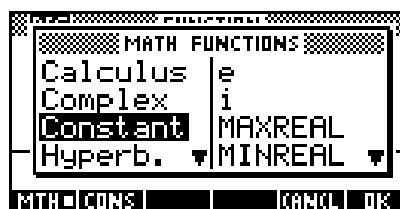

## The 'List' group of functions

### CONCAT({list})

This function concatenates two lists - appending one on to the end of the other in the order that you specify.

Eg.  $L1 = \{2, 5, -2, 10, 3.75\}$   
 $L2 = \{1, 2, 3, 4, 5\}$

$CONCAT(L1, L2) = \{2, 5, -2, 10, 3.75, 1, 2, 3, 4, 5\}$

$CONCAT(L1, \{5\}) \rightarrow L1$  would add another element of value 5 onto the end of list L1, storing the resulting longer list back into L1.

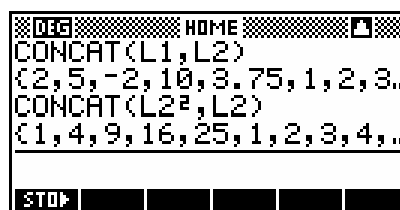
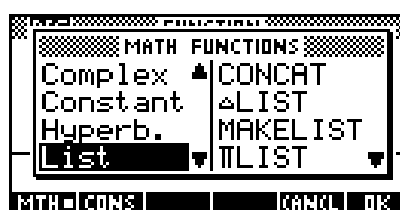

## **$\Delta$ LIST({list})**

This function produces a list which contains the differences between successive values in the supplied list. The resulting list has a length one less than the original.

Eg. L1={1,4,7,10,13}

$\Delta$ LIST(L1)={3,3,3,3}

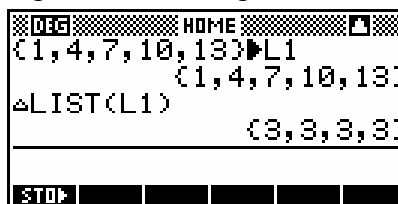

## **MAKELIST**

This function produces a list of the length specified using a rule of your choice. It is very useful, not only in programming but in statistical simulations and modeling.

The syntax is: **MAKELIST**(*expression, variable name, start, end, increment*)

where <i>expression</i>	is the mathematical rule used to generate the numbers.
<i>variable name</i>	is the variable that is to be used in the expression (any other letters will be taken constants).
<i>start</i>	is the first value that <i>variable name</i> is to be given.
<i>end</i>	is the largest value that <i>variable name</i> is to take.
and <i>increment</i>	is the amount that <i>variable name</i> should be incremented by.

Eg. 1 **MAKELIST**(  $x^2$ , X, 1, 10, 2)  $\blacktriangleright$  L1  
produces { 1, 9, 25, 49, 81 } as X goes from 1 to 3 to 5 to ...  
and also stores the result into L1.

Eg. 2 **MAKELIST**(RANDOM, X, 1, 10, 1) produces a set of 10 random numbers. The X in this case serves only as a counter.

Eg. 3 **MAKELIST**(3, X, 1, 10, 2)  
produces {3, 3, 3, 3, 3, 3, 3, 3, 3, 3}.

The MAKELIST function can also be used to simulate observations on random variables.

For example, suppose we wish to simulate 10 Bernoulli trials with  $p = 0.75$ . We can use the fact that a test like  $(X < 4)$  or  $(Y > 0.2)$  returns a value of either 1 (if the test is true) or 0 (if the test is false).

```

DEG HOME
MAKELIST(3,X,1,10,1)
(3,3,3,3,3,3,3,3,3,3)
MAKELIST(RANDOM<.75,X...
(1,0,1,1,1,1,0,0,1,1)
STOP

```

Thus:

```
MAKELIST(RANDOM<0.75,X,1,10,1)
```

will return a list of 1's and 0's corresponding to the simulated Bernoulli trials.

Various examples of this process are given in the 'Tips and Tricks' section which immediately follows the chapter on Univariate Statistics. See page 130.

### $\pi$ LIST({list})

This function returns the product of all the elements of a list.

Eg.  $\pi$ LIST({2, 3, 5}) would return a value of 30.

### POS({list},num)

This function conducts a search of a list. It returns the position in the list of the first occurrence of the number you specify (see example right). It is of more use to programmers, who will not know in advance what a list contains.

```

DEG HOME
L1
(1,8,5,7,10,13)
POS(L1,10)
5
STOP

```

If the number specified is not in the list it returns zero. If the value occurs in more than one place then only the first position is reported. The value specified can be either a number (as shown) or a variable or an expression to be evaluated.

### **SIZE({list}) and SIZE(matrix)**

This function returns the size of the list or matrix specified. Since normal users would probably know anyway, and could find out easily via the list catalog, this is clearly another of those functions which are of more use to programmers (who won't know when they write their program just how long the list you will ask it to deal with will be when you eventually run the program). If the object is a matrix then the return value is a two element list as {rows, columns}.

### **$\Sigma$ LIST({list})**

This function returns the sum of all the elements of a list.

Eg.  $\Sigma$ LIST({2, 3, 5}) would return a value of 10.

### **REVERSE({list})**

This function reverses the order of elements in a list.

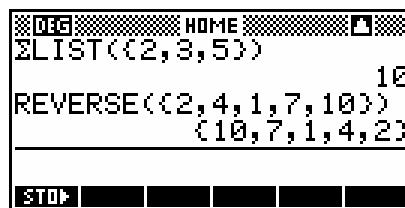

```
DEG HOME
 $\Sigma$ LIST({2,3,5})
10
REVERSE({2,4,1,7,10})
{10,7,1,4,2}
STOP
```

Eg. REVERSE({2, 4, 1, 7, 10}) would return {10, 7, 1, 4, 2}

### **SORT({list})**

This function returns a list that is sorted into ascending order.

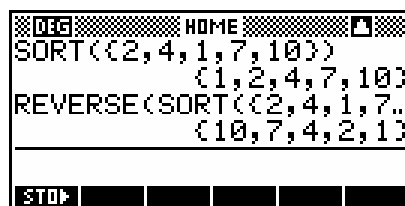

```
DEG HOME
SORT({2,4,1,7,10})
{1,2,4,7,10}
REVERSE(SORT({2,4,1,7,10}))
{10,7,4,2,1}
STOP
```

If you want the list in descending order instead then use REVERSE(SORT({list})).

See page 147 for an example of using SORT to assign rank orders.

## The 'Loop' group of functions

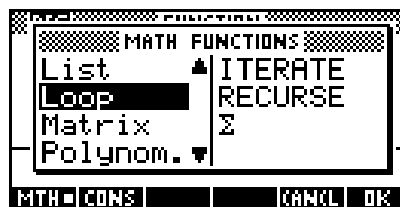

This is an interesting group of functions that may be of use for students studying discrete functions and sequences.

### *ITERATE(expression, var.name, strt, num.iter.)*

This function evaluates an expression a specified number of times, starting with a supplied initial value and using the answer to the previous evaluation as the value for the variable in the next evaluation.

Eg.  $ITERATE(X^2-1, X, 2, 5)$  gives an answer of 15745023

This answer is obtained as follows:



initial value:	X=2	first iteration
	$x^2 - 1 = 3$	
	↙	
new value:	X=3	second iteration
	$x^2 - 1 = 8$	
	↙	
new value	X=8	third iteration
	$x^2 - 1 = 63$	
	↙	
new value	X=63	fourth iteration
	$x^2 - 1 = 3968$	
	↙	
new value	X=3968	fifth iteration
	$x^2 - 1 = 15745023$	

Final answer: X = 15 745 023

## RECURSE

This functions is provided for programmers to let them define functions in the Sequence applet.

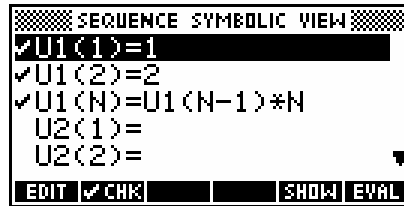

For example, typing RECURSE(U, U(N-1)\*N, 1, 2) ►U1(N) seemingly produces no useful result in the HOME view, but would produce the result shown right in the SYMB view of the Sequence applet. The resulting sequence is the factorial numbers.

The syntax is:

RECURSE(<seq.name>,<defn of term n>,<1st term>,<2nd term>)

and it must be **STO**ed into a sequence such as U1, U2 . . U9, U0 for it to have any meaning.

## Σ (SUMMATION)

This function, also available on the keyboard, offers a way of calculating the results of summation notation problems. The syntax of the function is ordered in the same way as one reads a summation expression (see the examples below).

Eg. 1  $\sum_{i=1}^5 i^2$  which expands to  $1^2 + 2^2 + 3^2 + 4^2 + 5^2$  giving an answer of 55,  
can be evaluated using  $\Sigma(I=1, 5, I^2)$

Eg. 2  $\sum_{i=1}^6 x_i$  where  $x_1 = -2, x_2 = 10, x_3 = 13, x_4 = 11, x_5 = -20, x_6 = 2$

can be evaluated by first defining a list L1 as  $\{-2, 10, 13, 11, -20, 2\}$   
and then calculating  $\Sigma(I=1, 6, L1(I))$

Note: Although 'i' was used as the summation index in each of the cases above, there is nothing special about them. 'i' and 'j' are simply the letters traditionally used in mathematical problems.



## The 'Matrix' group of functions

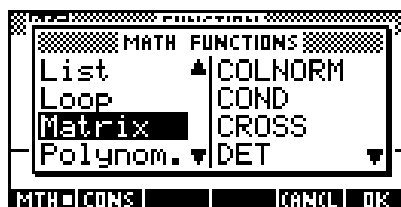

This very extensive group of functions is provided to deal with matrices.

The scope of functions and abilities covered in this group is in fact vastly greater than would be required by the average high school student or teacher. In many cases supplying an explanation in more detail than the manual of what the function is used for would occupy many pages to no real useful gain. Consequently many of the functions will be covered only by the comment "See User's manual".

A detailed set of examples for the more commonly used functions is given in the chapter titled "Using Matrices on the hp 39g+". See page 170.

### **COLNORM**

See User's manual

### **COND**

See User's manual

### **CROSS([vector],[vector])**

This function finds the cross product of two vectors. Vectors for this function are written as single row matrices.

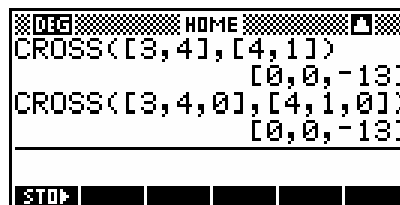

For example,  $a = (3,4,0)$  or  $\begin{pmatrix} 3 \\ 4 \\ 0 \end{pmatrix}$  would be written as  $[3,4,0]$ .

Note: If you want to use the **Matrix Catalog** to define your matrices for use with this function then you must use the **NEW** key to define them as real vectors rather than as matrices as the CROSS function is one of the few for which this matters.



### **DET(matrix)**

This function finds the determinant of a square matrix. See page 174 for an example of its use in finding an inverse matrix.



Eg. If  $A = \begin{bmatrix} 2 & 3 \\ -1 & 5 \end{bmatrix}$  then find  $\det(A)$ .

$$\begin{aligned} \text{Ans: } \det(A) &= 2 \times 5 - 3 \times (-1) \\ &= 13 \end{aligned}$$

See also: [INVERSE](#), [RREF](#)

### **DOT([vector],[vector])**

This function returns the dot product of two vectors. Vectors for this function are written as single row matrices.

For example,  $a = (3,4)$  or  $\begin{pmatrix} 3 \\ 4 \end{pmatrix}$  would be written as  $[3,4]$ .

See page 175 for a worked example.

### **EIGENVAL**

See User's manual

### **EIGENVV**

See User's manual

### **IDENTMAT(size)**

This function creates an  $n \times n$  square matrix which is an identity matrix. For example,  $\text{IDENTMAT}(4)$  would produce a  $4 \times 4$  identity matrix for use or storage.



## INVERSE(matrix)

This function produces the inverse matrix of an  $n \times n$  square matrix, where possible. A fully worked example of the use of an inverse matrix to solve a 3 by 3 system of equations is given in the chapter on using matrices on the hp 39g+ on page 172 and 288.

An error message is given (see right) when the matrix is singular (det. zero).

Note: Some people write the inverse matrix as a fraction (one over the determinant) multiplied by a matrix, so as to avoid decimals and fractions within the inverse matrix. The hp 39g+ does not do this. If you want the matrix with the determinant factored out, then evaluate  $\text{DET}(\text{matrix})$  first, record the fraction and then evaluate  $\text{DET}(\text{matrix}) * \text{INVERSE}(\text{matrix})$  to obtain the non-fractional matrix.

$$\text{i.e. } A = \begin{bmatrix} 2 & 3 \\ 4 & 5 \end{bmatrix} \Rightarrow A^{-1} = \frac{1}{-2} \begin{bmatrix} 5 & -3 \\ -4 & 2 \end{bmatrix}$$

Remember that the inverse matrix is not just the matrix, but the fraction times the matrix.

See also: [RREF](#), [DET](#)

## LQ(matrix)

This function takes an  $m \times n$  matrix, factors it and returns a list containing three matrices which are (in order):

- an  $m \times n$  lower trapezoidal matrix
- an  $n \times n$  orthogonal matrix
- an  $m \times m$  permutation matrix.

If you want to separate these matrices for later use then you should store them into a list variable.

For example, if **M1** was  $[[1,2,3],[4,5,6],[7,8,9]]$  then  $\text{LQ}(\text{M1}) \rightarrow \text{L1}$  would store the three resulting matrices into list variable **L1**. In the **HOME** view you could now enter  $\text{L1}(1) \rightarrow \text{M2}$  to store the first of the result matrices into **M2** and so on.

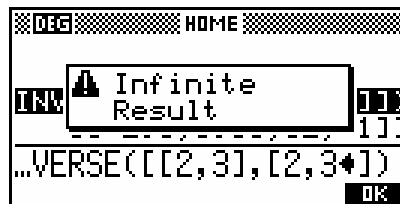

**LSQ**

See User's manual

**LU**

See User's manual

**MAKEMAT**

See User's manual

**QR**

See User's manual

**RANK**

See User's manual

**ROWNORM**

See User's manual

**RREF(matrix)**

This function takes an augmented matrix of size  $n$  by  $n+1$  and transforms it into reduced row echelon form, with the final column containing the solution.

Eg. The system of equations 
$$\left. \begin{array}{l} x - 2y + 3z = 14 \\ 2x + y - z = -3 \\ 4x - 2y + 2z = 14 \end{array} \right\}$$

is written as the augmented matrix

$$\left[ \begin{array}{ccc|c} 1 & -2 & 3 & 14 \\ 2 & 1 & -1 & -3 \\ 4 & -2 & 2 & 14 \end{array} \right]$$

which is then stored as a 3x4 real matrix M1.

We now use the function RREF to change this to reduced row echelon form and store it as M2.

M1	1	2	3	4
1	1	-2	3	14
2	2	1	-1	-3
3	4	-2	2	14

1				
EDIT	INS	GO+	BIG	
RREF(M1)→M2				
[[1, 0, 0, 1], [0, 1, 0, -2]...				
STOP				

This gives the final result shown in the matrix M2 on the right, giving a solution of (1, -2, 3).

M2	1	2	3	4
1	1	0	0	1
2	0	1	0	-2
3	0	0	1	3

1

EDIT INS GO+ BIG

The huge advantage of this function is that it allows for inconsistent matrices which can't be solved by an inverse matrix.

For example, suppose we use the system of equations below, in which the third equation is a linear combination of the first two but the constant is not consistent with this - ie no solution.

$$\begin{cases} x + y + z = 5 \\ 2x - y = -6 \\ 3y + 2z = 13 \end{cases}$$

If we solve this in the same way as before, the matrix which results is:

M2	1	2	3	4
1	1	0	0	0
2	0	1	0	0
3	0	0	0	1

1

EDIT INS GO+ BIG

The final line of 0 0 0 1 indicates no solution.

See also: [INVERSE](#), [DET](#)

### **SCHUR**

See User's manual

### **SIZE**

See User's manual

### **SPECNORM**

See User's manual

### **SPECRAD**

See User's manual

### **SVD**

See User's manual

### **SVL**

See User's manual

## **TRACE**

See User's manual

## **TRN(matrix)**

This function returns the transpose of an n x m matrix.

For example, if  $M1 = \begin{bmatrix} 2 & 3 \\ 1 & -2 \\ 0 & 4 \end{bmatrix}$  then TRN(M1) would return  $\begin{bmatrix} 2 & 1 & 0 \\ 3 & -2 & 4 \end{bmatrix}$ .

## The 'Polynomial' group of functions

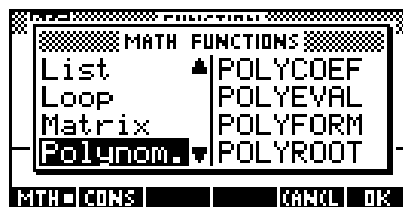

This group of functions is provided to manipulate polynomials.

We will use the following function to illustrate some of the tools in the Polynomial group.

$$f(x) = (x-2)(x+3)(x-1) = x^3 - 7x + 6$$

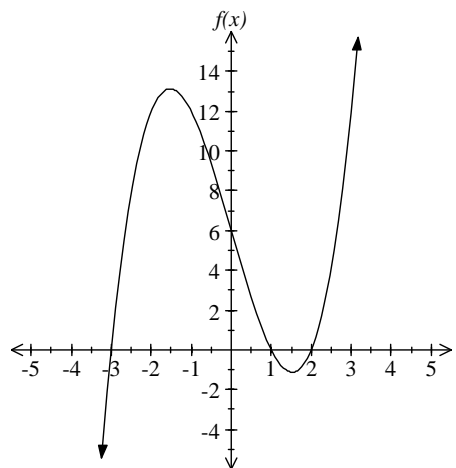

### **POLYCOEF([root1,root2,...])**

This function returns the coefficients of a polynomial with roots  $x_1, x_2, x_3, \dots$ . The roots must be supplied in vector form means in square brackets.

The function  $f(x)$  above has roots 2, -3 and 1. The screen shot below shows POLYCOEF correctly giving the coefficients as 1, 0, -7 and 6 for a final polynomial of  $f(x) = x^3 - 7x + 6$ .



### **POLYEVAL([coeff1,coeff2,...],value)**

This function evaluates a polynomial with specified coefficients at the point specified. The coefficients must be in square brackets, followed by the value of  $x$  (not in brackets). ie.  $f(x) = x^3 - 7x + 6$  has value 12 at  $x = 3$ .

Note: If evaluating more than one point it is probably more efficient to enter the function into the **SYMB** view of the Function applet. Then either use the **NUM** view to find the function values required, or simply type F1(3), F1(-2) etc. in the **HOME** view.

**POLYFORM(expression, var.name)**

This is a very powerful polynomial function. It allows algebraic manipulation and expansion of an expression into a polynomial. The expected parameters for the function are firstly the expression to be expanded, and secondly the variable which is to be the subject of the resulting polynomial. If the expression contains more than one variable then any others are treated as constants.

Eg. 1 Expand  $(2x-3)^3(x-1)^2$

Result:  $8x^5 - 52x^4 + 134x^3 - 171x^2 + 108x - 27$

The resulting polynomial is shown both as it appears in the HOME view and as it appears after pressing the **SHOW** key. Once it appears in the **SHOW** window, of course, it can be scrolled right and left to see the missing terms.

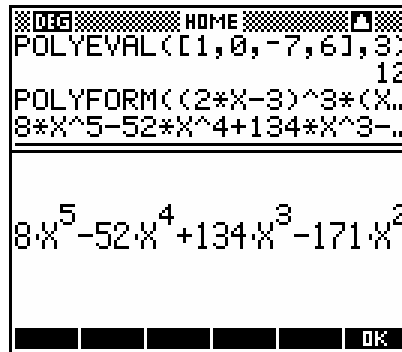

Eg. 2 Expand  $(3a-2b)^4$

This function contains two variables, A and B, which must be expanded separately.

The first expansion, treating A as the variable, is done using the expression `POLYFORM((3A-2B)^4,A)`. As you can see if you examine the view after pressing **SHOW**, the expansion of the expression in terms of A has been done, but the terms involving B are not fully evaluated.

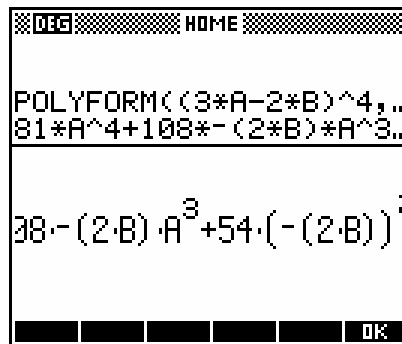

The solution to this is to use `POLYFORM` again. Use the **MATH** menu to fetch the `POLYFORM` function to the edit line, then move the cursor up to the partially evaluated expression that was the result of the previous `POLYFORM`. Copy it into the edit line and add a comma, a B and an end bracket. Pressing **ENTER** will now evaluate the terms involving B.

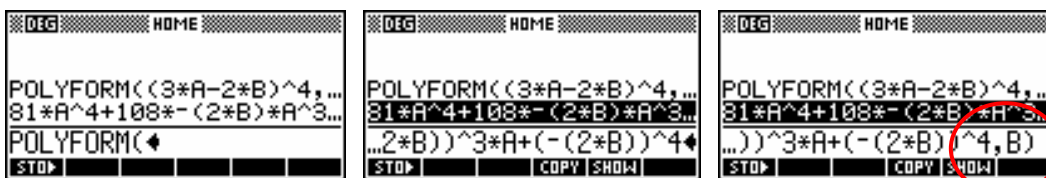

After pressing **ENTER** the for the second evaluation, the result is shown right (after pressing **SHOW**).

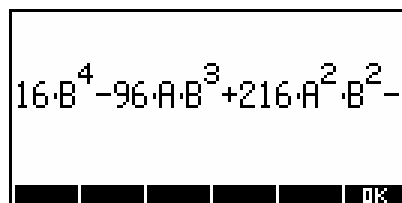

**POLYROOT([coeff1,coeff2,...])**

This function returns the roots of the polynomial whose coefficients are specified. The coefficients must be input as a vector in square brackets.



Eg. Using our earlier function of  $f(x) = (x-2)(x+3)(x-1) = x^3 - 7x + 6$  we can enter the coefficients as [1,0,-7,6].

As you can see in the screen shot, the roots of 2, -3 and 1 have been correctly found.

## The 'Probability' group of functions

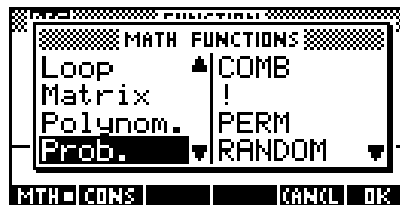

This group of functions is provided to manipulate and evaluate probabilities and probability distribution functions (p.d.f.'s).

### $COMB(n,r)$

This function gives the value of  ${}^nC_r$ , using the formula  ${}^nC_r = \frac{n!}{(n-r)!r!}$ .

Eg. Find the probability of choosing 2 men and 3 women for a committee of 5 people from a pool of 6 men and 5 women.

$$p = \frac{\binom{6}{2} \binom{5}{3}}{\binom{11}{5}} = 0.3247$$

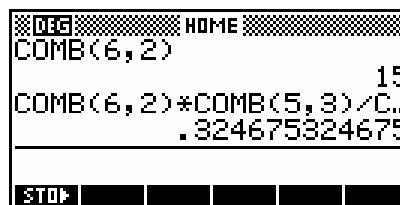

Note: The reason for the single ' $COMB(6,2)$ ' above the main calculation is to save time. Rather than using the **MATH** menu for every entry of the **COMB** function, you can enter it once and then **COPY** it repeatedly, changing the parameters.

### The ! function

The factorial function finds the number of possible permutations of an entire collection of  $n$  objects.

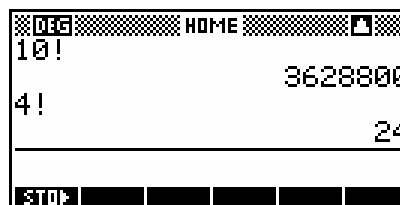

Eg. Find the number of 'words' that can be formed from the letters FRED.

$$\text{No. of words} = 4! = 24$$



## PERM(n,r)

This function gives the value of  ${}^n P_r$  using the

$$\text{formula } {}^n P_r = \frac{n!}{(n-r)!}.$$

Eg. How many ways can 3 Math, 4 English, and 6 German books be arranged on a shelf if all the books from a subject must be together?

$$\text{Ans: } ({}^3 P_3 \times {}^4 P_4 \times {}^6 P_6) \times 3!$$

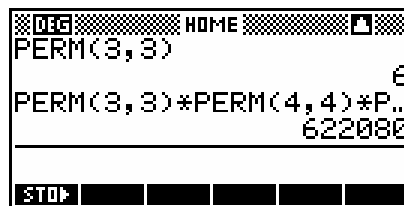

## RANDOM

This function supplies a random 12 digit number between zero and one. If you want a series of random numbers, just keep pressing ENTER after the first one.

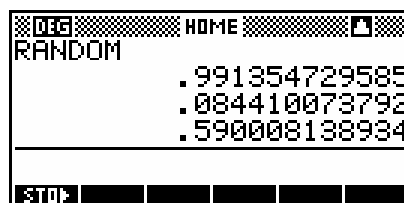

Eg. Produce a set of random integers between 5 and 15 inclusive.

Use the expression  $\text{INT}(\text{RANDOM} \times 11) + 5$ . The  $\text{RANDOM} \times 11$  produces a range from 0 to 10.999999. This is then dropped down to the integer below by the INT function, giving a range of integers 0, 1, 2, 3, ..., 10. The final adding of 5 gives the correct range.



It is important to realize that these are not truly random numbers. Inside the calculator is a mathematical procedure (an algorithm) which uses a 'seed' number to produce them. Unfortunately, taken straight out of the box, two hp 39g+'s will produce exactly the same sequence of "random" numbers! This can be a problem in that, for example, a class set of calculators doing a simulation of dice would all produce the same numbers.

The simple solution is to seed the random number algorithm with different values for each machine. This is done using the function **RANDSEED(...)** and, providing each person uses a different number, it should only be necessary to do it once (unless the calculator is reset). The simplest method is to use **RANDSEED(Time)** since the value of **Time** will be different on each calculator.



**UTPN(mean, variance, value)**

This function, the 'Upper-Tail Probability (Normal)', gives the probability that a normal random variable is greater than or equal to the value supplied. Note that the variance must be supplied, NOT the standard deviation.

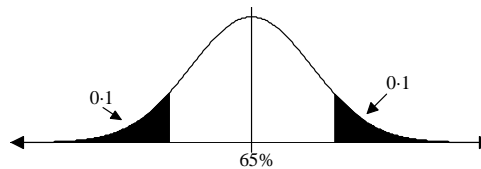

Eg. 1. Find the probability that a randomly chosen individual is more than 2 meters tall if the population has a mean height of 1.87m and a standard deviation of 10.4cm



$$\bar{x} = 1.87m, \sigma = 0.104m$$

$$\Rightarrow \sigma^2 = 0.010816$$

Ans:  $P(\text{height} > 2m) = 0.1056$

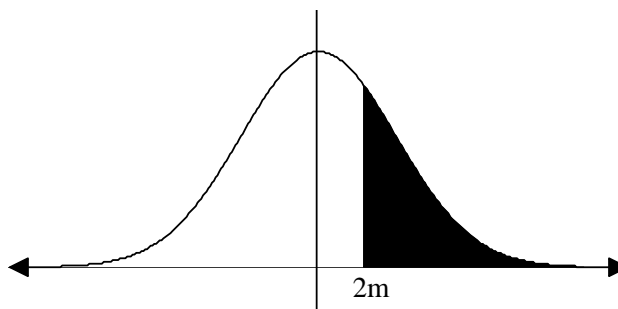

Eg. 2. The population of Year 12 Applicable Mathematics students had a mean exam score of 65% and a standard deviation of 14%. What two scores will cut off the top and bottom 10% of students?

i.e. Find  $x_0$  such that  $P(x > x_0) = 0.1$

Using the Solve aplet (right) we can reverse the normal direction of the UTPN function.

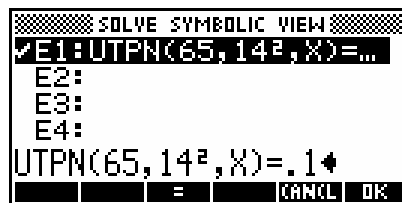

Enter the expression to be solved for into the SYMB view as shown above, then switch to the numeric view. Enter a guess of 0.8 (80%) and then press SOLVE.

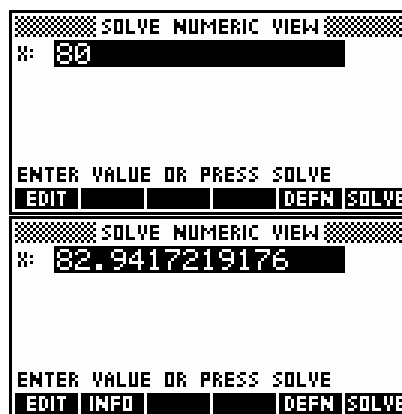

The second value can be found by using the symmetry properties of the Normal Distribution, but it is probably just as fast to go back to the SYMB view, change the 0.1 to 0.9 and then re-Solve. Remember that an EDIT key is provided in the SYMB view to allow you to change the expression without having to retype it.

Final answer... 47.06% and 82.94% are the cut-offs.



### **Calculator Tip**

The normal order for the arguments in the **UTPN** function is  $UTPN(\text{mean}, \text{variance}, \text{value})$ , giving the upper-tailed probability. However, many textbooks work with the lower-tailed probability instead. Fortunately the function can easily be adapted for this.

If you instead enter the function's parameters as  $UTPN(\text{value}, \text{variance}, \text{mean})$ , reversing the normal positions of *value* and *mean*, then the probability given will be the lower-tailed value. The reason for this lies in the symmetry properties of the normal curve.

### ***UTPC(degrees, value)***

This is the Upper-Tailed Chi-Squared probability function. It returns the probability that a  $\chi^2$  distribution with the supplied number of degrees of freedom is greater than the value supplied. See pages 150 & 299 for an example of this function's use.

### ***UTPF(numerator, denominator, value)***

This is the Upper-Tailed Snedecor's F probability function. It returns the probability that a Snedecor's F distribution with numerator degrees of freedom (and denominator degrees of freedom in the F distribution) is greater than the supplied value.

### ***UTPT(degrees, value)***

This is the Upper-Tailed Student's t probability function. It returns the probability that a Student's t distribution with the supplied number of degrees of freedom is greater than the supplied value.

## APPENDIX A: WORKED EXAMPLES

The examples which follow are intended to illustrate the ways in which the calculator can be used to help solve some typical problems. In some cases more than one method is shown. Sometimes these problems are quoted elsewhere in the book and repeated here for convenience.

### Finding the intercepts of a quadratic

Find the x intercepts of the quadratic equation  $g(x) = 2x^2 + 2x - 1$

#### Method 1 - Using the QUAD function in HOME.

This method is shown right, using the **SHOW** key in the bottom view. The advantage of doing it this way is that the answer is given in the same form that you would see it if you used the Quadratic formula. Just **COPY** the result, edit and square the decimal part to find the value of the discriminant. The 'S1' is the calculator's version of the  $\pm$  sign. Just **COPY** the result and remove the S1 to obtain the positive solution, replacing the + with a - to obtain the other. This method is only of use if the question said "Show working" because it doesn't give the answer directly. If you need the result in surd form then copy just the decimal part and square it.

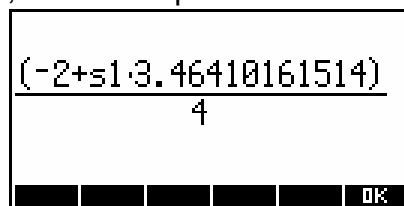
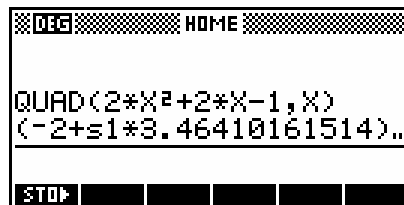

#### Method 2 - Using the Function aplet.

Shown right. Enter the function into the **SYMB** view, use the **VIEWS** key and choose 'Decimal'. If the axes don't suit, then use the **ZOOM** options. Now use the **FCN** option of *Root* to find the two roots. One result is shown.

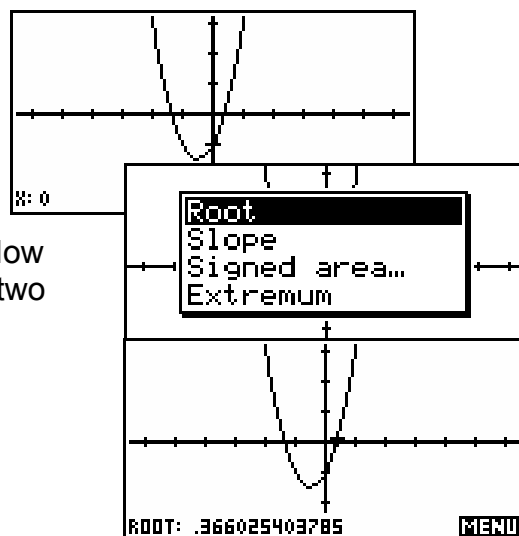

### Method 3 - Using the POLYROOT function

The advantage of this is that it can be done in the HOME view and is quick and easy. See page 91 for a method of copying the results to a matrix so as to gain easier access to them.



### Finding complex solutions to a complex equation

Find the roots of the complex equation  $f(z) = z^2 + z + 1$ .

#### Method 1 - Using the QUAD function

Since this is a quadratic it can be done with the QUAD formula mentioned in example 1., since it is capable of giving complex results. This is shown right, rounded to 4 dec. pts. It's up to you of course to realize that (0,1.7321) is  $\sqrt{3}i$  but if you don't recognize it then **COPY** just that portion and square it. The 'S1' means  $\pm$ .

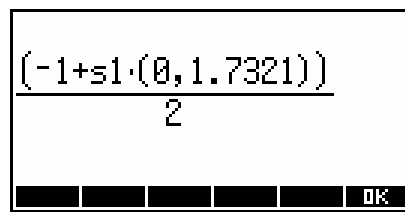

#### Method 2 - Using POLYROOT

An alternative method is to use the POLYROOT function and store the results to a matrix. This offers the advantage of being able to examine the result more easily by **EDIT**ing the matrix, and also of being able to access each root by referring to the matrix elements in a calculation (eg M1(1), M1(2) etc.).

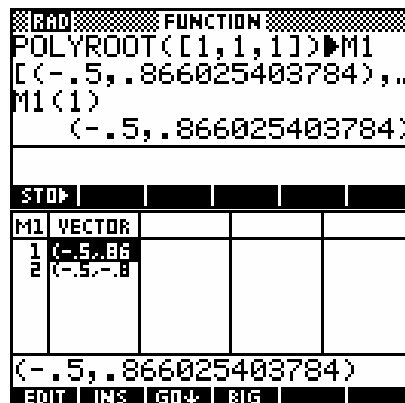

## Finding critical points and graphing a polynomial

For the function  $f(x) = x^3 - 4x^2 + x + 6 \dots$

- (i) find the intercepts.
- (ii) find the turning points.
- (iii) draw a sketch graph showing this information.
- (iv) find the area under the curve between the two turning points.

Step 1. Enter the function into the **SYMB** view of the Function applet, so it is available for plotting.

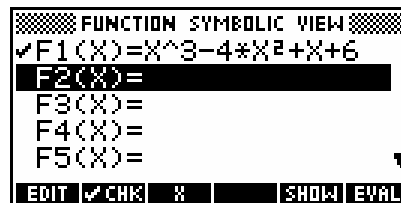

Step 2. Use the **POLYROOT** function to find the roots. This function is in the **MATH** menu in the *Polynom.* group.

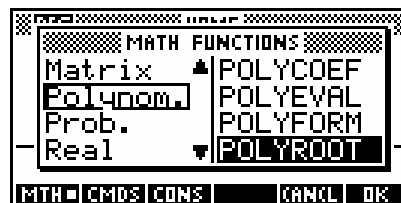

The results show that the x intercepts are  $(-1,0)$ ,  $(2,0)$  and  $(3,0)$ . The y intercept is found by evaluating  $F1(0)$  in the **HOME** view giving the point  $(0,6)$ .



Step 3. Switching to the **PLOT** view via **VIEWS** - **Decimal**, you will find that the function does not display as well as it could. Since it is the y axis that is not displaying enough, we will use the 'Y-Zoom Out' option in the **ZOOM** menu after first setting the Zoom factors to 2 rather than 4 (which is too drastic).

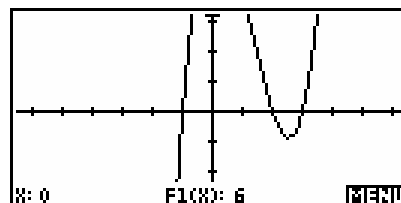

Now use the **FCN** pop-up menu to find the *Extremum* (both left and right).

The snapshot right shows the left-hand turning point of  $(0.131, 6.065)$ .

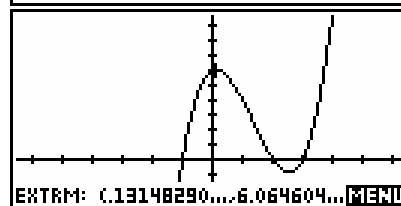

Step4. Because I know that part (iv) of the question requires me to re-use these extremum values in an integration (which I would like to be as accurate as possible), I am going to 'save' the extremum value just found. I change into the **HOME** view and store it as shown in memory **A**.

**Note:** You **MUST** store the point of interest before moving the cursor in the **PLOT** view. As soon as the cursor moves its new position over-writes the extremum value. If you want the y coordinate, just evaluate  $F(X)$ . Now use the **FCN** - Extremum tool again to find and store the x coordinate of the second turning point into memory **B**.

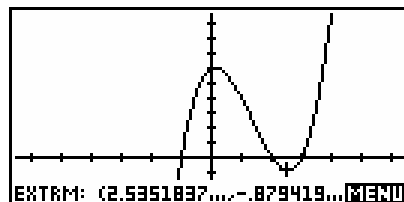
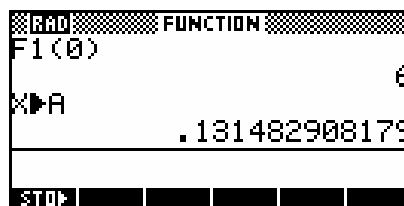

Step 5. The **PLOT** view shows that part of the area we require for part (iv) is negative, so we need to know the x intercept between the two turning points. Fortunately we know from Step 2 that it is the point  $(2,0)$ . If we did not know this already, then we could use the **FCN** menu again, retrieving this time from the **VAR** menu the variable called 'Root' and perhaps storing that into memory **C**. We will evaluate the integral in the **HOME** view where you can use the accurate values you stored in Step 4. It needs to be done in two parts and added (subtracted actually to reverse the sign of the negative part). This is shown right, with the **COPY** key having been used to add the values.

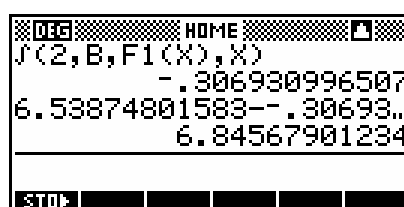
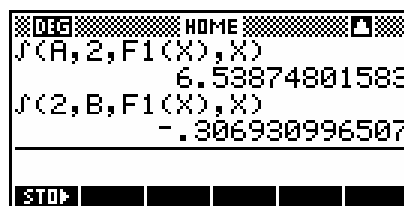

## Solving simultaneous equations.

Solve the systems of equations below:

$$(i) \quad \left. \begin{aligned} 2x - 3y &= -7 \\ x + 4y &= 2 \end{aligned} \right\}$$

$$(ii) \quad \begin{aligned} 2x - y &= 4 \\ -3x + 2y - z &= -10.5 \\ x - 3y + z &= 10.5 \end{aligned}$$

### Method 1 - Graphing the lines

Because the first set of equations is a 2x2 system it can be graphed in the Function applet. To do this it is necessary to re-arrange the functions into the form  $y = \dots\dots$  and store them into F1(X) and F2(X) in the SYMB view of the Function applet. Switch to the PLOT view and use the **FCN** Intersection tool to find the point of intersection.

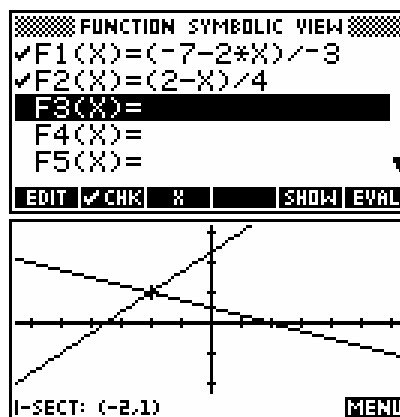

It is worth noting that although the point of intersection is on the screen here, this is not necessary. The **FCN** Intersection tool will work even if neither line is visible on the currently set axes.

### Second method - using a matrix

Step 1. Rewrite  $\left. \begin{aligned} 2x - 3y &= -7 \\ x + 4y &= 2 \end{aligned} \right\}$  as  $\begin{bmatrix} 2 & -3 \\ 1 & 4 \end{bmatrix} \begin{bmatrix} x \\ y \end{bmatrix} = \begin{bmatrix} -7 \\ 2 \end{bmatrix}$

This means that  $\begin{bmatrix} x \\ y \end{bmatrix} = \begin{bmatrix} 2 & -3 \\ 1 & 4 \end{bmatrix}^{-1} \times \begin{bmatrix} -7 \\ 2 \end{bmatrix}$

Step 2. Switch into the Matrix Catalog (**SHIFT MATRIX**). Position the highlight on M1 and press **EDIT**. Enter the matrix shown right.

M1	1	2		
1	2	-3		
2	1	4		
2				
EDIT INS GO+ BIG				

Press **SHIFT MATRIX** to change back to the catalog and create M2 as shown below right. Note that setting **GO+** will make it easier to enter M2.

M2	1			
1	-7			
2	2			
EDIT INS GO+ BIG				



Step 3. Change into the **HOME** view and enter the calculation  $M1^{-1} * M2$ . The result is the (x,y) coordinate of the solution.



A similar method can be used to solve the second 3x3 system of equations.

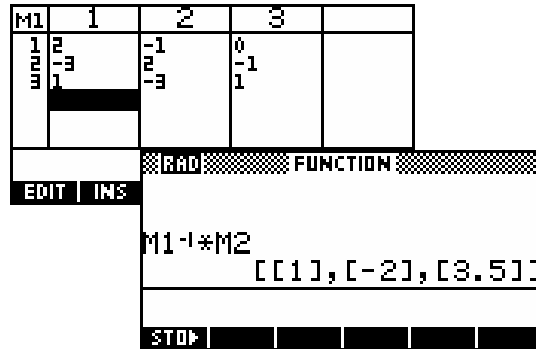

**Third method - using the 3x3 Solver applet**

This method uses an applet which is available from the internet called the “Simult 3x3”.

It allows easy solution of 2x2 and 3x3 systems of linear equations in a format which is more user friendly than the use of matrices for student who are not familiar with them.

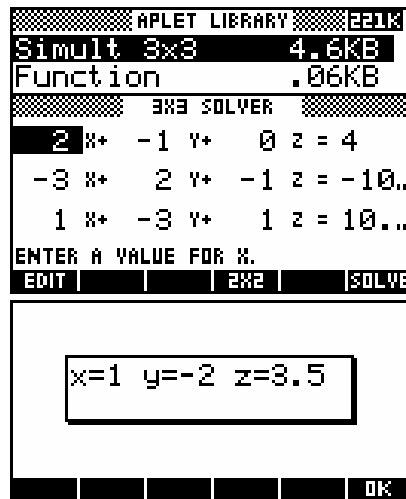

## Expanding polynomials

Expand the expressions below.

(i)  $(2x+3)^4$

(ii)  $(3a-2b)^5$

- (i) Use  $\text{POLYFORM}((2X+3)^4, X)$  to expand the polynomial. Use the **SHOW** key to examine the result.

Result:

$$16x^4 + 96x^3 + 216x^2 + 216x + 81$$

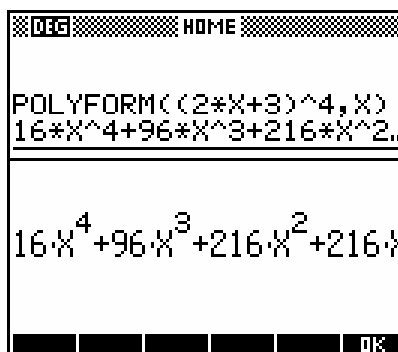

- (ii) Use  $\text{POLYFORM}((3A-2B)^5, B)$  to expand the polynomial as a function of B. Then use the polynomial function again, **COPY**ing the result from the first expansion and expanding this time as a function of A. The **SHOW** key can then be used to view it, using the left and right arrows to scroll the screen left and right.

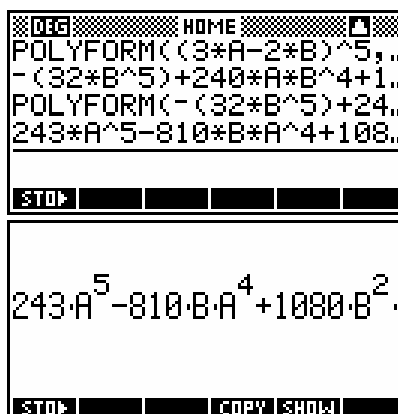

Result:  $243a^5 - 810a^4b + 1080a^3b^2 - 720a^2b^3 + 240ab^4 - 32b^5$

## Exponential growth

A population of bacteria is known to follow a growth pattern governed by the equation  $N = N_0 e^{kt}$  ;  $t \geq 0$  . It is observed that at  $t = 3$  hours, there are 100 colonies of bacteria and that at  $t = 10$  hours there are 10,000 colonies.

- (i) Find the values of  $N_0$  and of  $k$ .
- (ii) Predict the number of bacteria colonies after 15 hours.
- (iii) How long does it take for the number of colonies to double?

(i) Find  $N_0$  and  $k$ .

n	C1	C2	C3	C4
1	3	100		
2	10	10000		

STATISTICS SYMBOLIC SETUP			
ANGLE MEASURE: Radians			
S1FIT:	ExpFit	S2FIT:	Linear
S3FIT:	Linear	S4FIT:	Linear
S5FIT:	Linear		
CHOOSE STATISTICS MODEL TYPE			
	CHOOS		

Step 1. Start up the Statistics aplet, set it to **DATA** and enter the data given. Change to the **SYMB SETUP** view and specify an *Exponential* line of best fit for the data.

Step 2. Change to the **PLOT SETUP** view and adjust it so that it will display the data. (This is not really needed, since the line of best fit is what we need and it will be calculated even if the data doesn't show.) **YTick** is set to 1000 incidentally.

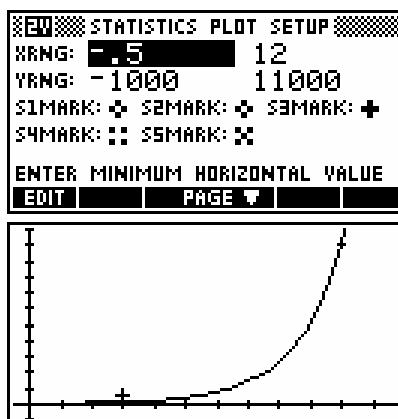

Now change to the **PLOT** view and press **FIT** (if not already set). Wait while the line draws.

Step 3. Change to the **SYMB** view, move the highlight to the equation of the regression line and press **SHOW**. Rounded to 4 dec. places, this gives an equation of:

13.8949549437·EXP(.6579t)

OK

$$N = 13.8950e^{0.6579t}$$

(ii) Predict  $N$  for  $t = 15$  hours.

Change to the **HOME** view and use the **PREDY** function.

Result: 268 269 colonies.

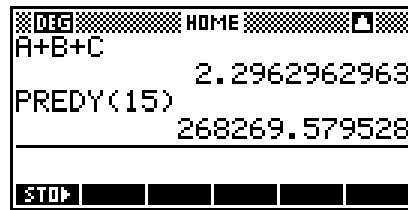

(iii) Find  $t$  so that  $N = \frac{1}{2}N_0$ .

Step 1. Find the values of  $N_0$  and  $k$  and store  $N_0$  into memory A and  $k$  into memory K, so that it is un-necessary to re-type them.

See page 145 for instructions on finding the parameters from the exponential fit curve.

Step 2. Switch to the Solve aplet and enter the equation to be solved. Changing into the **NUM** view, you should find the values of A and K already defined, so move the highlight to T and press **SOLVE**.

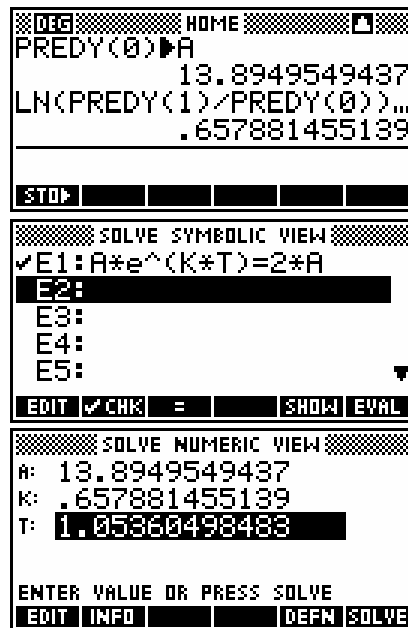

Result: Doubling time is 1.0536 hours.

## Solution of matrix equations

Solve for the value of X in  $A(I - 2X) = B$

where  $A = \begin{pmatrix} 2 & 3 \\ -1 & 5 \end{pmatrix}$ ,  $B = \begin{pmatrix} 3 & -2 \\ 1 & 4 \end{pmatrix}$

$$A(I - 2X) = B$$

$$I - 2X = A^{-1}B$$

$$-2X = A^{-1}B - I$$

$$X = \frac{-1}{2}(A^{-1}B - I)$$

Store the values of A and B into M1 and M2 respectively.

The image shows two screenshots of a TI-84 Plus calculator interface. The first screenshot shows matrices M1 and M2 being stored. M1 is a 2x2 matrix with values 2, 3, -1, and 5. M2 is a 2x2 matrix with values 3, -2, 1, and 4. The second screenshot shows the calculation of the expression  $-.5*(M1^{-1}*M2 - \text{IDENMAT}(2))$  stored into M3. The result is shown as a decimal matrix:  $[[.038461538462, .846153846154], [-.192307692308, .153846153846]]$ . The third screenshot shows the same calculation with the MODES view set to Decimal 6, resulting in the fractional matrix:  $[[1/26, 11/13], [-(5/26), 26*M3]]$ .

Finally use the **HOME** view to calculate the answer, using the function **IDENMAT(2)** to produce a 2x2 identity matrix, and making sure to store the result into **M3**.

In this case the result is a horrible decimal. The fractional equivalent can be found by setting the **MODES** view to *Decimal 6* and then re-evaluating, as shown right. From this it can be seen that the common denominator seems to be 26, so multiplying **M3** by 26 will give a final result of:

$$X = \begin{pmatrix} 1 & 22 \\ -5 & 7 \end{pmatrix}$$

## Inconsistent systems of equations

Solve each of the systems of equations below, where possible, indicating in each case the nature of the system.

$$\begin{array}{lll}
 2x - 3z = -7 & 2x - 3z = -7 & 2x - 3z = -7 \\
 \text{(a) } x + y + 4z = 15 & \text{(b) } x + y + 4z = 15 & \text{(c) } x + y + 4z = 15 \\
 x + 2y - z = 2 & 3x + y + z = 8 & 3x + y + z = 7
 \end{array}$$

M1	1	2	3	4
1	2	0	-3	-7
2	1	1	4	15
3	1	1	1	8

2

EDIT INS GO+ BIG

## Using the RREF function

In each case the most efficient method is to use the function **RREF**. The letters **RREF** stand for Reduced Row Echelon Form and the advantage of this function is that it allows the user to deal with matrices which are singular.

M1	1	2	3	4
1	2	0	-3	-7
2	1	1	4	15
3	1	1	-1	8

HOME

RREF(M1)→M2

[[1, 0, 0, 1], [0, 1, 0, 2], ...

EDIT

STOP

- (a) Entering the augmented matrix of coefficients into M1 (see above) we then use the **RREF** function, storing the result into M2.

This result can be examined via the **Matrix Catalog**. It can be seen that the result is a diagonal of 1s, with the result given in the final column.

Here:  $x = 1, y = 2, z = 3$

M2	1	2	3	4
1	1	0	0	1
2	0	1	0	2
3	0	0	1	3

1

EDIT INS GO+ BIG

- (b) Since the coefficients are similar, we can edit the augmented matrix in **M1** and then re-use the line in the **HOME** view.

In this case the final line of zeros indicates that the original matrix is singular and that there are an infinite number of valid solutions.

M2	1	2	3	4
1	1	0	-1.5	-3.5
2	0	1	5.5	18.5
3	0	0	0	0

1

EDIT INS GO+ BIG

- (c) A similar method for the third set of coefficients yields the result shown right. The final line of  $0\ 0\ 0\ 1$  indicates that there is no valid solution.

M2	1	2	3	4
1	1	0	-1.5	0
2	0	1	5.5	0
3	0	0	0	1

1

EDIT INS GO+ BIG

## Finding complex roots

- (i) Find all roots of the complex polynomial  $f(z) = z^3 + iz^2 - 4z - 4i$ .
- (ii) Find the complex roots of  $z^5 = 32$ .

The best way to do this is using **POLYROOT**. I usually **STO** the results into a matrix, since the matrices on the hp 39g+ can be complex vectors, not just real matrices.

- (i) The coefficients can be entered into **POLYROOT** in the form  $a+bi$  or as  $(a,b)$ . In this case the roots are integers so there is no need to store it into a matrix.

Coefficients must be in square brackets separated by commas.

```

DEG HOME
POLYROOT([1,i,-4,-4*i...
[(0,-1),(-2,0),(2,0)]
STO
    
```

- (ii) The method is to solve the complex polynomial  $z^5 - 32 = 0$ , setting the other coefficients to zeros. This is shown in the second **POLYROOT** calculation in the screen shot right.

```

DEG HOME
POLYROOT([1,i,-4,-4*i...
[(0,-1),(-2,0),(2,0)]
POLYROOT([1,0,0,0,0,-...
[(.61803398875,-1.902...
...([1,0,0,0,0,-32])M1
STO COPY SHOW
    
```

In this case the results are unlikely to be integers so we store them into **M1**. The result is shown below and right. The edit line shows the highlighted element to a greater degree of accuracy. Unfortunately there is no way on the hp 39g+ to get exact surds as your answer.

M1	VECTOR			
1	0.6180...			
2	0.6180...			
3	-1.61...			
4	-1.61...			
5	(2.0)			

```

(.61803398875,-1.9021...
EDIT INS GOV BIG
    
```

## Analyzing vector motion and collisions

Ship A is currently at position vector  $21\mathbf{i} + 21\mathbf{j}$  km and is currently travelling at a velocity of  $-4\mathbf{i} + 6\mathbf{j}$  km/hr. Ship B is at  $30\mathbf{j}$  and travelling at  $2\mathbf{i} + 3\mathbf{j}$  km/hr. If the ships continue on their present courses, show that they will not collide and find the distance between them at the time of their closest approach.

Firstly enter the equations for the ships' paths into the **Parametric** applet using the first equation pair for ship A and the second for ship B.

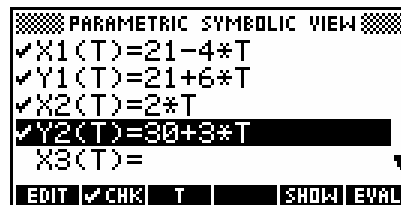

Making a guess at the ships' behavior and position, I will set up the axes as shown on the right. I am assuming that the collision will occur in the first 6 seconds and in the axes range chosen. This can always be adjusted if my guess is wrong. The reason for choosing -15 on the **YRng** is to ensure that the x axis is visible on the screen. Notice in the second screen that *Simult*: must be checked if the plot is to be a good illustration of the ship's movements.

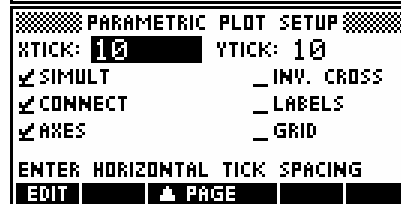
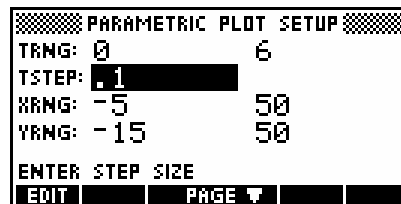

If you've done this correctly then you will see the ship's movements on the plot view. Careful examination of the paths of the ships as they appear on the screen will show visibly that they do not collide. The graph is shown on the right just before closest approach. However we need to verify this.

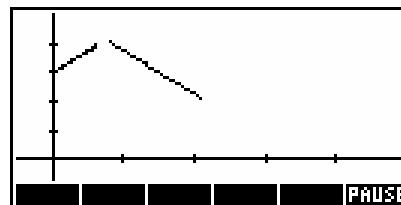

The formula for the distance between the ships is  $d = \sqrt{(x_1 - x_2)^2 + (y_1 - y_2)^2}$  and this can now be entered into the Function applet as shown right. With an equation this complex it is probably worth checking with the **SHOW** key that you have typed it correctly. Notice that the active variable in Function must be X not the T used in Parametric.

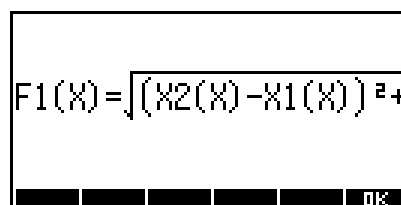
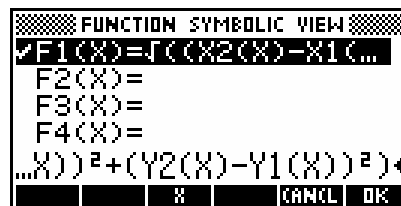



I want to graph this function for the first six seconds but I am not sure what y scale to use so I will set XRng to be 0 to 6 in the **PLOT SETUP** view and then choose **VIEWS - Auto Scale**. The result is shown right.

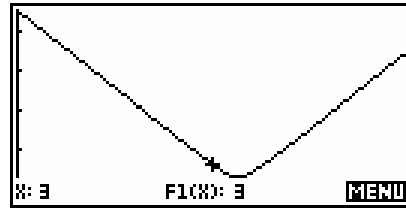

Using **FCN - Extremum**, I find that the time of closest approach is at  $t = 3.4$  hours (3:24 pm) with a separation at that time of  $d = 1.3416$  km. The y axis has been adjusted slightly to make the x axis visible.

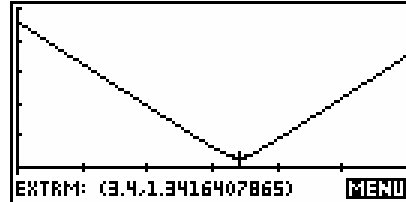

### Circular Motion and the Dot Product

A particle's position at time  $t$  seconds is given by  $r = 5\sin\theta i - 5\cos\theta j$ . Draw a sketch of its path for the first 6 seconds of movement. Show algebraically that its path is circular.

The first step is to graph the particle's path. We go into the Parametric applet and enter the rule into the first equation **X1, Y1**.

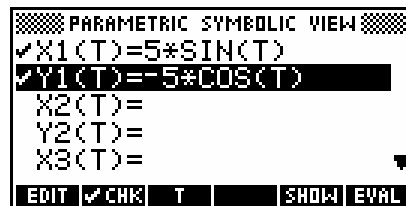

After setting TRng to 0 to 6 and then using **VIEWS - Auto Scale** we get a result which does not look like a circle, but this may be due to distortion through not using a 'square' screen.

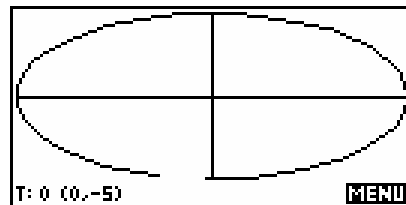

If we inspect the **PLOT SETUP** view, we can see that the settings are nearly double those of the default 'square' screen of  $-6.5$  to  $6.5$  and  $-3.1$  to  $3.2$ . In the **PLOT SETUP** view, press **SHIFT CLEAR** to set everything back to default, then double each setting for the x and y axes and set TRng back to 0 to 6. Pressing **PLOT** again will make it clear visually that this is a circle and we can copy this diagram onto our test paper as the required graph. Note the gap at the bottom because the TRng stops at 6 instead of  $2\pi$ .

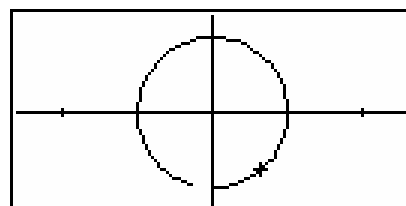
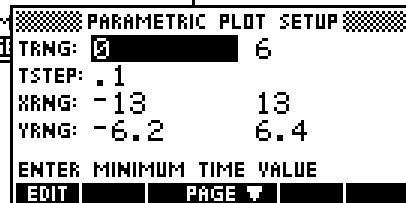
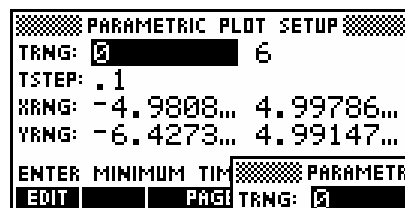

The simplest way to show that the motion is circular is to show that the dot product of the velocity and acceleration vectors is constantly zero for all theta. This should be done algebraically, but just for fun we'll see if we can do it with the calculator too.

Use X2 & Y2 to hold the velocity and X3 & Y3 to hold the acceleration, pressing **EVAl** after each one to perform the differentiation.

Now we go to the Function aplet and enter the formula for the required dot product as  $X2(X)*X3(X)+Y2(X)*Y3(X)$ .

If we now switch to the **NUM** view, we can see that this function is evaluating to zero for  $t = 0, 1, 2, 3...$  Of course this is not the same as a proper algebraic proof but you wouldn't want the calculator to do *all* the work would you?

```
PARAMETRIC SYMBOLIC VIEW
✓X1(T)=5*SIN(T)
✓Y1(T)=-5*COS(T)
✓X2(T)=∂T(X1(T))
✓Y2(T)=∂T(Y1(T))
X3(T)=
EDIT ✓CHK T SHOW EVAL
```

```
PARAMETRIC SYMBOLIC VIEW
✓X2(T)=5*COS(T)
✓Y2(T)=-5*-SIN(T)
✓X3(T)=∂T(X2(T))
✓Y3(T)=∂T(Y2(T))
X4(T)=
EDIT ✓CHK T SHOW EVAL
```

```
FUNCTION SYMBOLIC VIEW
✓F1(X)=X2(X)*X3(X)+...
F2(X)=
F3(X)=
F4(X)=
F5(X)=
EDIT ✓CHK X SHOW EVAL
```

X	F1		
0	0		
1	0		
2	0		
3	0		
4	0		
5	0		

NUM

ZOOM BIG DEFN

## Inference testing using the $\chi^2$ test

A teacher wishes to decide, at the 5% level of significance, whether the performance in a problem solving test is independent of the students' year at school. The teacher selected 120 students, 40 from each of Years 8, 9 & 10, and graded their performance in a test as either A or B.

Year	Grade awarded		Total
	A	B	
8	22	18	40
9	26	14	40
10	27	13	40
Total	75	45	120

The table above right shows the results.

The hypotheses being tested are:

$H_0$ : There is no relationship between grades awarded and years at school. They are independent.

$H_A$ : There is a relationship.

If  $H_0$  is true then the expected frequencies should be those in the table on the right.

Year	Grade awarded		Total
	A	B	
8	25	15	40
9	25	15	40
10	25	15	40
Total	75	45	120

Enter the observed and expected frequencies into columns C1 and C2 of the Statistics aplet.

In the **HOME** view, perform the calculation shown right. This calculates the individual  $\chi^2$  values ready for summing as per the

$$\text{formula } \chi^2 = \sum \frac{(O - E)^2}{E}$$

After first changing to the **SYMB** view to register C3, the required total for C3 can be found in the **STATS** view. In this case, 1.493.

n	C1	C2	C3	C4
1	22	25		
2	18	25		
3	26	25		
4	27	25		
5	14	15		
6	13	15		
7				
8				
9				
10				
11				
12				
13				
14				
15				
16				
17				
18				
19				
20				
21				
22				

EDIT | INS | SORT | BIG | 1VAR | STATS

Rad STATISTICS

(C2-C1)<sup>2</sup>/C2>C3

0.36, .04, .16, .6, 6.666...

STOP

1-VAR	H1		
ME	6		
TOTZ	1.493333333		
MEANZ	24888888		
SVARZ	.0387808		
CVARZ	.0441363		
PSDEV	.1917818		
1.493333333333			
OK			

Changing into the Solve aplet we can enter a formula which will allow us to calculate values from the  $\chi^2$  distribution using the UTPC function.

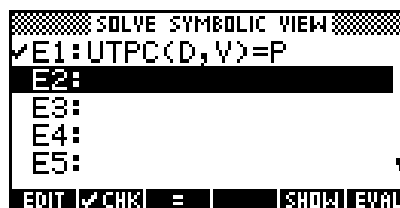

With a 3 x 2 contingency table the number of degrees of freedom are 2. To find the critical  $\chi^2_{0.05}$  value, we enter values of 2 for D (the degrees of freedom) and 0.05 (the probability) and then move the highlight to V (the value) and press **SOLVE**. As it turns out, the required critical value is 5.99 and so we would accept the null hypothesis and conclude no relationship.

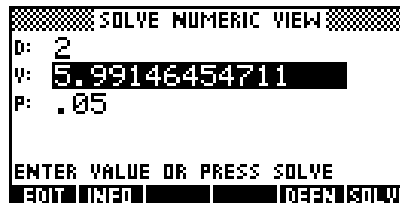

## APPENDIX B: TEACHING CALCULUS WITH AN HP 39G+

There are many ways that the teaching of functions and calculus concepts can be enhanced with the aid of an hp 39g+ graphical calculator. Some of them are listed below:

### *Investigating* $y = x^n$ for $n$ an integer

This can be done most economically by setting an investigation, perhaps for homework.



Save a copy of the Function aplet under the name of "X to the N". Saving the aplet will allow you to send it to your students' calculators.

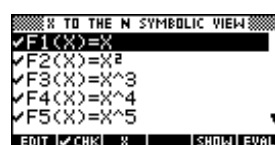

Into this aplet, enter the functions shown and set the axes as shown. The choice of x axis means that each pixel is 0.02 apart.

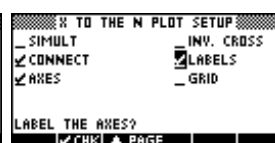
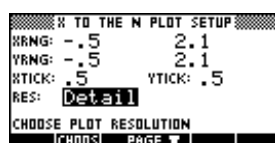

This aplet can now be sent to each student's calculator at the end of a lesson using the infra-red link.

Accompanying questions should address the issues below, and students should be required to either hand in a short written response, or contribute to a verbal discussion the next day.

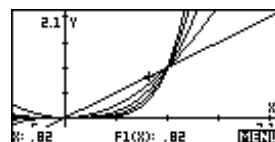

- (i) All the graphs have two points in common. What are they and why are they common?
- (ii) Why does an increasing value of  $n$  mean a lower value of  $f(x)=x^n$  between 0 and 1, while it means a higher value for  $x > 1$ ?
- (iii) What happens for  $x < 0$ ? (The scale will need to be changed in the **PLOT SETUP** view.)
- (iv) What do the graphs of  $y = x^n$  look like for negative integer values of  $n$ ?

## Domains and Composite Functions

There are a number of ways that the calculator can help with this. Examples are given below but others will no doubt occur to experienced teachers.

- (i) Rational functions can be investigated using the **NUM** view. For example, enter the functions  $F1(X)=X+2$  and  $F2(X)=(X^2-4)/(X-2)$ . Discussion will elicit the fact that they are 'identical' algebraically but what then about the point  $X=2$  in the **NUM** view (see right)? Use this in discussion to introduce the convention of graphing with a 'hole'.

X	F1	F2
1.7	3.7	3.7
1.8	3.8	3.8
1.9	3.9	3.9
2.0	4.0	UNDEF.
2.1	4.1	4.1
2.2	4.2	4.2

You can also have a great deal of fun with the class by telling them to un-**CHK**  $F1(X)$  and then to zoom in repeatedly on  $X=2$  in the **PLOT** view in an effort to "find the hole". They won't of course, but you can laugh watching them and then discuss why they didn't - a good way to introduce the idea of limits!

FUNCTION SYMBOLIC VIEW		
<input checked="" type="checkbox"/>	$F1(X)=X(X-1)$	
<input type="checkbox"/>	$F2(X)=$	
<input type="checkbox"/>	$F3(X)=$	
<input type="checkbox"/>	$F4(X)=$	
<input type="checkbox"/>	$F5(X)=$	

X	F1
1.7	UNDEF.
1.8	UNDEF.
1.9	UNDEF.
2.0	0
2.1	.3162278
2.2	.4472136

**However - there is a trick to this!** If you use the default axes of -6.5 to 6.5 then there *will* be a hole (see right) because  $x=2$  falls on a pixel point and so, since it is undefined, the calculator leaves it out.

For this to work you need to sabotage their efforts in advance via a scale which does not have  $x=2$  on a pixel. Starting with a scale like this ensures that subsequent box zooms won't produce the "hole". A good scale is -1 to 6 on both axes and you can rationalize the choice by telling them that it "focuses well on the point we're interested in". They may still sabotage this by choosing their own axes when zooming.

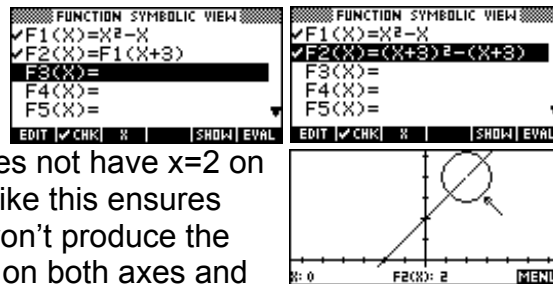

- (ii) When discussing the concept of a domain, the **NUM** view can be very useful in developing this (see right).

FUNCTION SYMBOLIC VIEW		
<input type="checkbox"/>	$F1(X)=\sqrt{X}$	
<input type="checkbox"/>	$F2(X)=X^2$	
<input checked="" type="checkbox"/>	$F3(X)=F1(F2(X))$	
<input checked="" type="checkbox"/>	$F4(X)=F2(F1(X))$	
<input type="checkbox"/>	$F5(X)=$	

  

X	F3	F4
-1	1	UNDEF.
-.75	.75	UNDEF.
-.5	.5	UNDEF.
-.25	.25	UNDEF.
0	0	0
.25	.25	.25
.5	.5	.5

- (iii) Composite functions can be introduced directly in the **SYMB** view. For example, enter  $F1(X)=X^2-X$  and  $F2(X)=F1(X+3)$ . Move the highlight to  $F2(X)$  and press the **EVAL** button. If desirable, you can further simplify using **POLYFORM**. With the highlight on  $F2(X)$ , press **EDIT**. Move the highlight to the start of the expression and use the **MATH** button to enter “**POLYFORM**(”. Now move to the end and add “**,X**” to the expression and press **OK**. Pressing **EVAL** again now will give the result shown right.

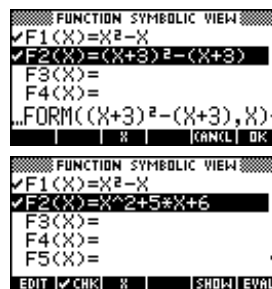

- (iv) Domains of composite functions can be explored in the **NUM** view. In the **SYMB** view, enter the functions shown right, uncheck the first two non-composite functions. In the **NUM** view shown, I have used the **NUM SETUP** view to set the scale to start at -1 and increase in steps of 0.25. Obviously discussion will now center on why  $f(x)=\sqrt{x^2}$  is not the same as  $f(x)=x$ , and why  $f_1(f_2(x))$  is not the same as  $f_2(f_1(x))$  for  $x<0$ .

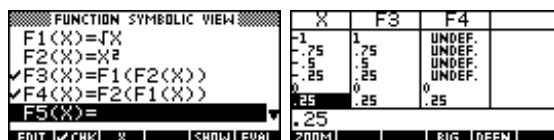

## Gradient at a Point

This is best introduced using an applet called “Chords” downloaded from *The HP HOME View* web site (at <http://www.hphomeview.com>), but you can also use the Function applet.

In the Function applet, enter the function being studied into  $F1(X)$ . To examine the gradient at  $x=3$ , store 3 into  $A$  in the **HOME** view as shown right, then return to the **SYMB** view and enter the expression shown right into  $F2(X)$ .

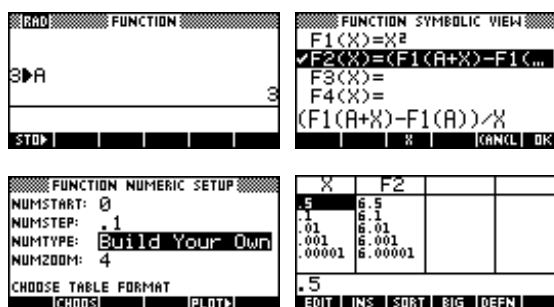

Change to the **NUM SETUP** view and change the NumType to “Build Your Own”. You can now enter successively smaller values for  $X$  in the **NUM** view, since  $X$  is taking the role of  $h$  in the expression  $f'(a) = \lim_{h \rightarrow 0} \frac{f(a+h) - f(a)}{h}$ .

To investigate the gradient at a different point, change back to the **HOME** view, enter a new value into  $A$  and then return to the **NUM** view.

The disadvantage of the previous method is that it is not very visual. An alternative is to use the “Chords” applet.

In this applet, a menu is provided via the **VIEW** menu to allow students to choose from a list of predefined functions or enter their own. Once the function has been graphed, the ‘Show slopes’ option will display an animated series of chords of diminishing length, with the gradient displayed at the top of the screen. As the chord shortens the student can see how this affects the approximation to the gradient at the point chosen.

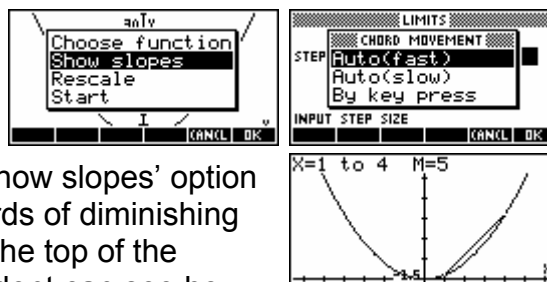

## Gradient Function

Once the concept of gradient at a point has been established the next step is to develop the idea of a gradient function. This can be done using an applet downloaded from *The HP HOME View* web site called “Tangent Lines”. This applet will add a moveable tangent line to a graph, allowing the user to move it along the curve with the gradient displayed at the top left of the screen.

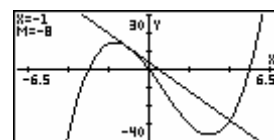

There are two worksheets included in the documentation which is bundled with this applet which will take the student through the process of developing a gradient function.

If it is not desirable to use this applet then the Statistics applet can be used to help with the process of finding gradient functions once tabular data has been collected giving  $x$  and  $grad(x)$  values. If the student enters the data into C1 and C2, they can then set to **EDIT**, plot the data and make a guess as to the appropriate function and then use the curve fitting facilities to find an equation.

Curves of the form  $y = mx + b$ ,  $y = ax^2 + bx + c$ ,  $y = ax^3 + bx^2 + cx + d$  and  $y = ax^b$  can be fitted using the Statistics applet and this should be enough for the students

to deduce the rule  $\frac{d(x^n)}{dx} = nx^{n-1}$  for themselves. It is advisable to ensure that

the students are familiar with the process of using the Statistics applet to find equations before commencing, otherwise the two concepts may interfere.



## The Chain Rule

If desirable, an applet is available from *The HP*

*HOME View* web site (at <http://www.hphomeview.com>), called "Chain Rule", which will encourage the student to deduce the Chain Rule for themselves.

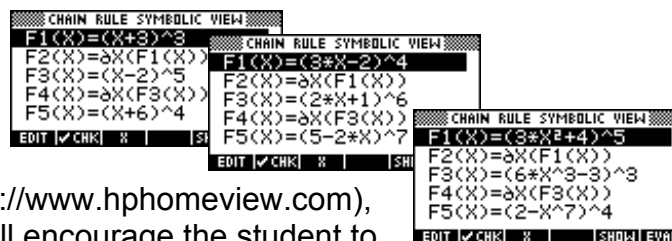

It is pre-loaded with five sets of functions, of increasing complexity, the first three of which are shown right. The functions are loaded into F1, F3, F5, F7 and F9, while the functions F2, F4, F6, F8 and F0 contain an expression which, when **EVAL** is pressed, will differentiate the function above. Through the worksheet which is bundled with the applet, the student is directed to record the functions and their derivatives and to look for patterns which will allow them to deduce a rule.

## Optimization

A method which I find to be efficient in introducing the idea of optimization is via the maximization of the volume of an open-topped box.

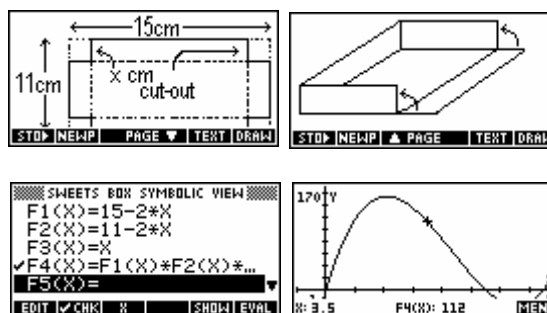

If we start with a sheet of card which is 15cm by 11cm then we can form

a box by removing squares from the corners and folding up the sides. I find that it is quite helpful for the students to actually make such a box, choosing for themselves what size square to cut out. They can then explore, using the Function applet, what cut-out size will produce the maximum volume.

As can be seen above right, the width, length and height can be entered into F1, F2 and F3 as functions of the cut-out size X. The volume can then be entered into F4 as F1\*F2\*F3 and this function can then be plotted and the maximum found either through successive approximations in the **NUM** view or by using the **FCN** tools in the **PLOT** view.

## Area Under Curves

This topic is most easily handled using an applet from *The HP HOME View* web site (at <http://www.hphomeview.com>). This applet, called “Curve Areas” will draw rectangles either over or under a curve or use trapezoids. A number of curves are supplied pre-set but the user can also enter their own. The user can nominate the interval width and the number of rectangles.

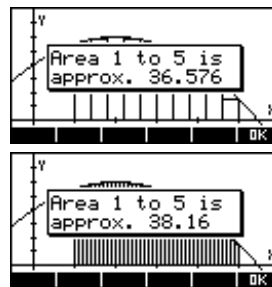

Most importantly, a worksheet is bundled with the applet which will lead the student through the process of deducing an area function and hence to the anti-differentiation of  $x^n$ .

## Fields of Slopes and Curve Families

One of the concepts which students find quite difficult to come to grips with is that of sketching a field of slopes from a derivative function and, from this, sketching a family of curves. An applet from *The HP HOME View* web site (at <http://www.hphomeview.com>), called “Slope Fields”, will assist with this process.

In this applet the user enters the derivative function into F1(X) and then uses the **IEWS** menu to produce a field of slopes. A cross-hair is projected onto the field which the user can move around. When the user presses **ENTER**, a curve is drawn, starting at that point and projecting to the right and then the left, and following the field of slopes. Repetition of this will illustrate the fact that there are a family of curves, separated by a constant, which all fit the ‘description’ of the function stored in F1(X).

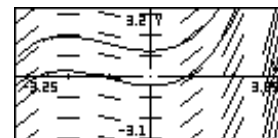

## ***Inequalities***

The topic of inequalities is one that is sometimes included in calculus courses, particularly during the study of domains and this is often extended to graphing intersecting regions such as  $\{(x, y) : y \leq 0.5x + 1 \cap y \geq x^2 - 1\}$ .

Although the hp 39g+ does not have the in-built ability to plot inequalities, the process is easily handled using an applet from *The HP HOME View* web site (at <http://www.hphomeview.com>) called "Inequations". This allows the user to plot individual or overlapping inequalities as shown right. It will not handle dotted functions of the form  $y < f(x)$ .

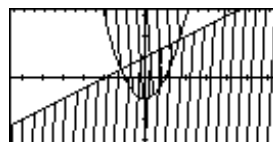

## ***Rectilinear Motion***

A topic which is commonly taught as part of any calculus course is rectilinear motion. This can be enhanced by using the Parametric applet to graphically illustrate the motion of a particle. If this is set up properly then it can be a very helpful teaching aid, as the graph will slow down and speed up as it appears, illustrating the velocity and acceleration of the particle.

See page 104 for a fully worked example of how the Parametric applet can be used to produce motion graphs of the form shown right. The graph needs to be seen as it is being drawn to appreciate how the particle slows down and speeds up as it passes the turning points. Try it and see.

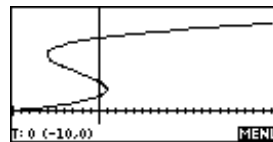

## ***Limits***

For information on evaluation of limits on the hp 39g+ and, more importantly, the pitfalls that lie in wait for the unwary, please read the information in the chapter "Tips & Tricks - Function" on page 88.

## Piecewise Defined Functions

Piecewise defined functions can be graphed easily on the hp 39g+ by breaking them up into their components.

For example:

$$f(x) = \begin{cases} \sin(x) & ; x < -2 \\ x+2 & ; -2 \leq x \leq 1 \\ (x-2)^2 - 1 & ; x > 1 \end{cases}$$

Using the Function aplet, we enter three separate component functions. You can obtain the inequality signs from the **CHARS** menu.

$$\begin{aligned} F1(X) &= \text{SIN}(X)/(X < -2) \\ F2(X) &= (X+2)/(-2 \leq X \text{ AND } X \leq 1) \\ F3(X) &= ((X-2)^2 - 1)/(X > 1) \end{aligned}$$

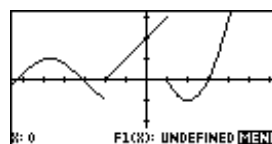

The calculator evaluates the domain as either true (1) or false (0) for each value of x. When it is zero (outside the domain) then dividing by this value causes the function to become undefined and consequently not be graphed. Inside the domain it has no effect.

**Note:** The word 'AND' is available from the keyboard above the (-) sign.

## Sequences and Series

Through the Sequence aplet the hp 39g+ provides very flexible tools for the investigation of sequences. These can easily be adapted to investigate series as well.

Information and worked examples of using the hp 39g+ for evaluation of sequences and series can be found in the chapter "Tips & Tricks - Sequences and Series" on page 110.

**Note:** One of the common errors that students make in the Solve aplet is to try to solve for solutions which do not exist. For example, a student will try to solve for N in  $T = A \cdot R^{(N-1)}$  with  $A=50$ ,  $R=0.75$  and  $T = -2$ . The result will be firstly that the calculator will seem to freeze while it tries to find a solution which can only be approached asymptotically.

Finally the calculator will give the result as shown right. The problem is that students will misinterpret it as being  $N=10$ , when in fact it is simply that the calculator has gone as far along the positive x axis as possible and stopped at MAXREAL of  $1 \times 10^{500}$  (see second screen shot). It is recommended that the teacher should deliberately provoke this error and follow with class discussion.



Students should also be encouraged to press the **INFO** button after finding a solution since a case like this will give 'Extremum' whereas a correct solution will result in either 'Zero' or 'Sign Reversal'. See the manual for more information.

### Transformations of Graphs

This topic can be handled in a number of ways. One of these is to use the Function applet without enhancement.

Enter the basic function into F1(X). For example, you might enter  $F1(X)=X^2$ . You can then enter transformations into the other functions. Some examples, together with the resulting graphs are shown right.



This process will also work with piecewise defined functions which are often the type that are used in examination questions.

There are also two applets which can aid greatly in this process called "Quad Explorer" and "Trig Explorer" and are built into the hp 39g+. Both of these applets

allow the student to explore the effect of changing parameters on the shape of the graph, one using a quadratic and the other with the sine and cosine curves. Students can choose to manipulate the graph and see the effect on the parameters, or to manipulate the parameters and see the effect on the graph. In Quad Explorer there is even a "test yourself" facility provided which will present the student with examples of quadratics for which they must provide an equation, with visual feedback on incorrect guesses. Highly recommended. See pages 164 - 167.

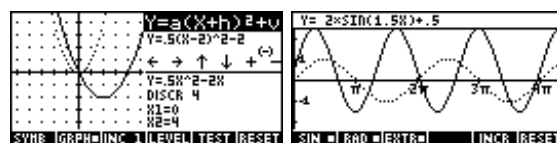

## APPENDIX C: THE HP 40G & ITS CAS

### Introduction

This appendix is intended to give a useful introduction and over view to the user who is new to an hp 40g. It is *not* intended to fully cover the topic, nor is it intended to serve as a reference text for the advanced user. For those needing a far more extensive coverage than is available here, I can highly recommend the incredibly detailed text “*Computer Algebra and Mathematics with the hp 40g, Version 1.0*” by Renée de Graeve, Lecturer at the University of Grenoble I and founder of the Grenoble IREM. It contains a complete reference of the functions for symbolic calculation, and also demonstrates, using many examples, how to take smart advantage of the calculating power of the hp 40g. This can be found at Hewlett Packard’s web site (<http://www.hp.com/calculators>) or on the Help page of *The HP HOME view* (<http://www.hphomeview.com>).

### What is a CAS?

Although you may not have thought about it consciously, you are probably aware that most calculators do not operate with algebra in the same way that a human does. Generally speaking solutions on computers and calculators are found using numeric means. This is often done by using successive approximations, each one coming closer and closer to the final answer.

You can see this process at work quite easily using the Solve aplet. All you need to do is enter an equation to solve which is complex enough to require more than a few seconds to solve. If you do this then you can watch the calculator work.

In the Solve aplet, enter the equation  $\int_0^X a^2 dx = 1000$  as shown right. This is equivalent to solving for  $a$  in the equation:  $\int_0^x a^2 dx = 1000$ .

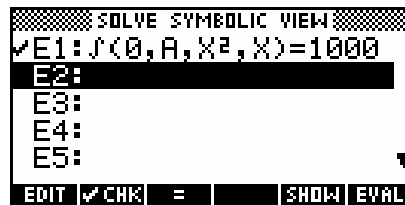

Change into the NUM view, and press **SOLVE** on X. As soon as the hour glass symbol appears, press the **SOLVE** button again. You may need to press it more than once before the calculator takes notice, but eventually you should see a view similar to the one right.



The two values at the top of the screen represent the calculator's successive approximations to the true solution. The chances are that one will have a '+' symbol to the left of it, while the other has a '-'. This is telling you that the '+' value is greater than required, while the '-' value is smaller. As you watch you should see the two values converge to the true answer.

But is it? The true answer is actually  $\sqrt[3]{3000}$ , as is shown right. Unless you realized that the value supplied was a cube root it is unlikely that you would get this exact solution.



Algebraically, the solution is shown to the right.

$$\int_0^a x^2 dx = 1000$$

$$\left[ \frac{x^3}{3} \right]_0^a = 1000$$

$$\frac{a^3}{3} = 1000$$

$$a = \sqrt[3]{3000}$$

On most calculators there is no way to obtain this exact answer because the calculator doesn't use algebra.

However, the CAS or Computer Algebra System on the hp 40g does use algebra! As you can see in the screen shots to the right, the CAS on the hp 40g is perfectly capable of giving you the algebraically correct answer, and it does it by following the same rules that you do.

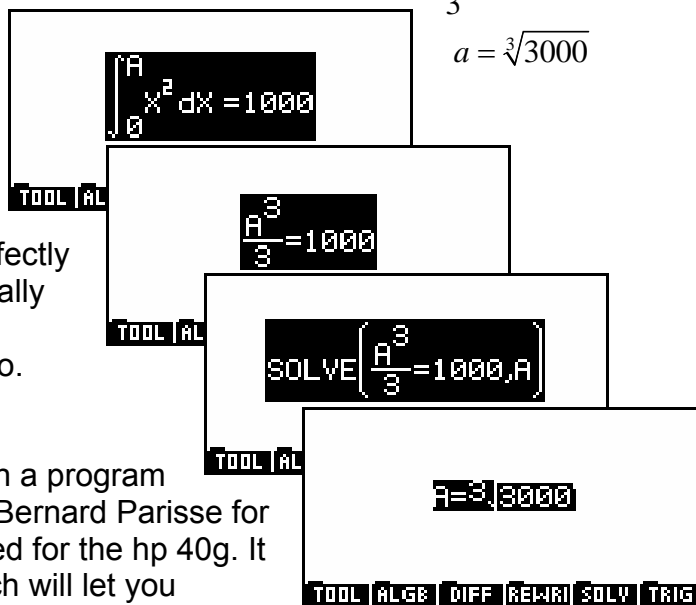

The CAS on the hp 40g is based on a program called **Erable**, originally written by Bernard Parisse for the HP49G, which was then adapted for the hp 40g. It is an amazingly powerful CAS which will let you perform virtually any mathematical manipulation you might need.

For an example of the fundamental difference between working in the CAS, with its exact mode & infinite precision, and working in the normal HOME view, in approximate mode with  $10^{-12}$  precision, you need only consider the two contrasting results of **ASIN(1)** and  $\frac{1}{9} \times 9$  shown to the right.

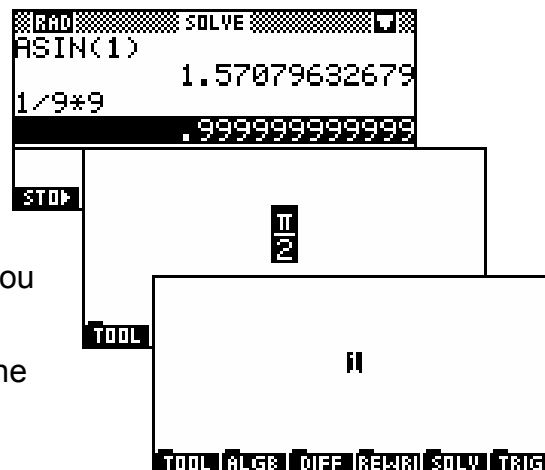

### ***What is the difference between the hp 39g, hp 40g & hp 39g+?***

At the time that the hp 39g was designed, as an upgrade from the original hp 38g, there were two competing sets of requirements. The European market wanted a calculator which had a CAS system but they were highly distrustful of the infra-red communication which was standard on the hp 38g, feeling that it might allow cheating in examinations. The US and Australian markets, on the other hand, wanted the infra-red communications but their educational systems were not yet prepared to allow the power of a CAS into their classrooms, feeling that it did too much of the students' work.

The solution adopted was to use the same chip for two calculators, the hp 40g and the hp 39g. These two models have, respectively, infra-red but no CAS and CAS but no infra-red. They are otherwise identical except for the label below the screen. The calculator's chip is able to detect which model it is in and activate or de-activate the CAS accordingly.

The hp 39g+, released in 2004, is an upgraded model of the hp 39g, the differences being vastly greater speed and the extra Finance aplet.

If you own an hp 39g and you are wondering if you can fool it into believing that it is an hp 40g and thereby activate the CAS, then please don't try it. If you disable the infra-red by, for example, cutting the internal wires then you won't have an hp 40g - you will simply have a crippled hp 39g. Nor is it possible to activate the CAS by means of a special program. It is possible to partially activate it but the result will be crippled to varying degrees and will not work properly, possibly even giving incorrect answers. In addition to this, any education system will very probably regard this as a serious instance of cheating if you use it in an examination and penalize you accordingly.

If you own an hp 39g+ then the question does not even arise because the code for the CAS was left out of the chip when it was upgraded to become the hp 39g+.



## Using the CAS

The first step is to activate the CAS. This is done from the HOME view by pressing screen key 6 (SK6), labeled **CAS**.

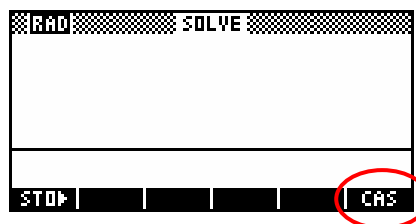

When you do, you will see an empty screen with a cursor in the center and an extensive menu system at the bottom of the screen.

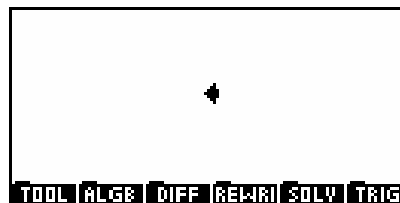

From the HOME screen, pressing **SHIFT CAS** will instead display the screen on the right. This is the **CAS MODES** screen. More information on this is given on page 329. This screen can be accessed within the CAS by pressing **SHIFT SYMB**.

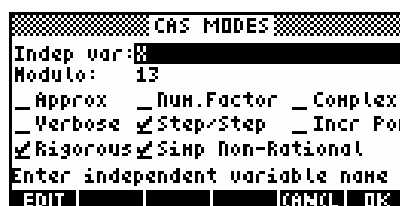

## Entering and editing an expression

When entering an expression the main point to remember is that evaluations and appending of operations are always done to the currently highlighted element. This is most easily seen with an example.

In the HOME view press **CAS** and then follow the sequence of keys below:

- (i) Press 2 **XT0** + 3 **X^** 4

In this case you will notice that the power of 4 was placed so that it applied only to the last character typed; the 3.

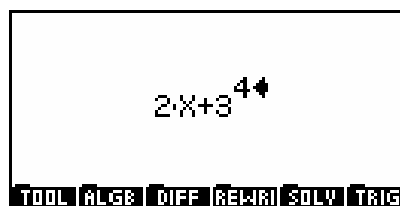

- (ii) Press up arrow twice. Then press **ENTER**.

Notice that pressing up arrow caused more and more of the expression to be highlighted. Pressing **ENTER** evaluated the currently highlighted expression of  $3^4$  to be 81.

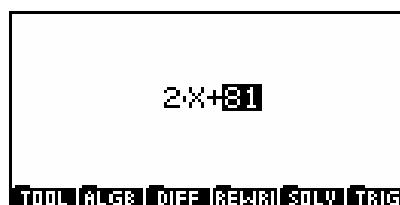

- (iii) Press left arrow once then down arrow once. Press  $\boxed{X^y}$  3, then press up arrow three times & finally press  $\boxed{X^y}$  2. (DO NOT use the  $\boxed{X^2}$  button for this.)



Notice that in each case the power was applied to the currently highlighted element of the expression. Brackets are automatically added as required.

Notice also the movement of the highlight. If you regard the original expression of  $2X+81$  as a tree of operations as shown right then it may make more sense. When you finished step 2 the highlight was on C, the node containing 81.

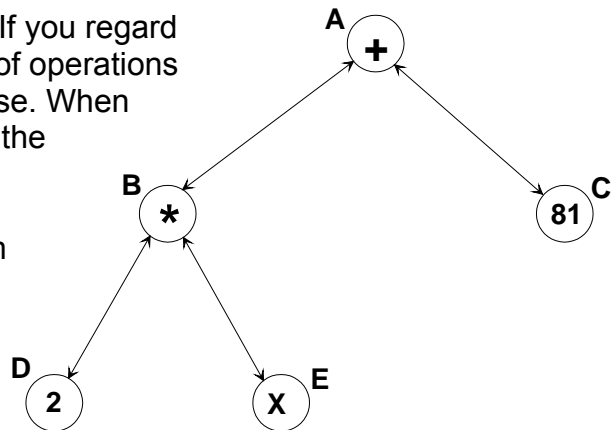

Pressing left arrow moved horizontally from node C to node B. The highlight at that point encompasses everything at or below node B. In this case this is the expression '2\*X'.

Pressing down arrow at that point moved down the tree. The default is to move to the left-most node D. This meant that the 2 was highlighted and so when you pressed  $\boxed{X^y}$  3 it was the expression that was cubed. At that point the tree now appears as shown right with the CAS in 'typing/editing mode' on node G.

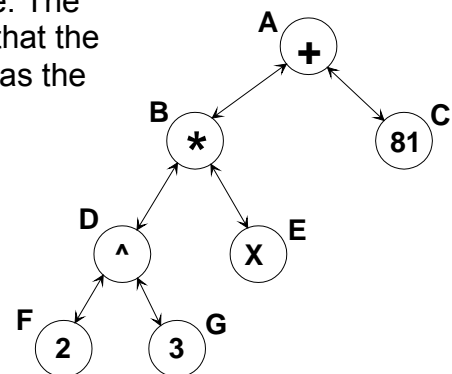

Pressing up arrow three times placed the highlight successively on nodes G, then D, then B. When  $\boxed{X^y}$  2 was pressed it squared the entire expression defined by node B which was '2^3X'. This necessitated brackets and so they were automatically added.

The result was the tree shown to the right, with nodes P and Q added below node A. You may notice that it is heavily canted to the left and this tends to be fairly typical of the way we generally write expressions.

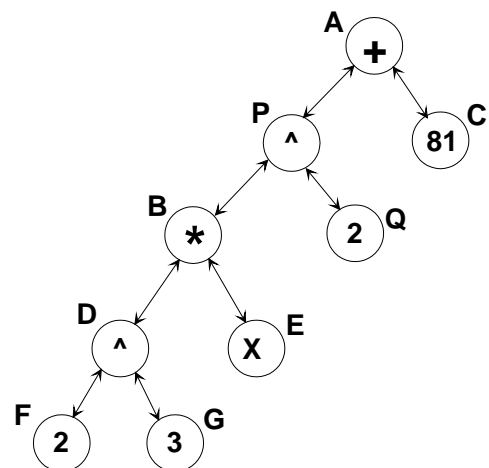

- (iv) Press up arrow three times and then divide by 5.

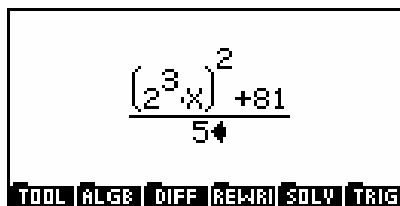

This moves the highlight up to node A, highlighting the entire expression. Dividing by 5 therefore applies to the entire expression, with the result shown right. The new tree is shown below with nodes R and S added above A.

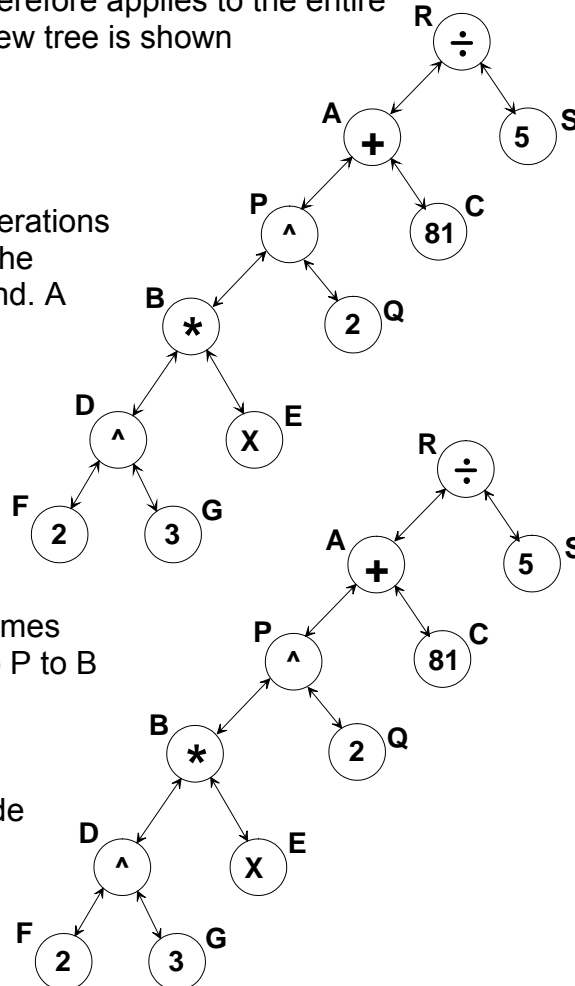

Although it is not strictly necessary for you to understand or use this concept of a tree of operations you will find that it will help you to follow why the highlight behaves as it does as it moves around. A final example may help with the visualization.

- (v) After typing the 5, press up arrow once to highlight that node S. If you now press left arrow you will find that the highlight will jump horizontally to node A, highlighting the entire numerator. Pressing down arrow four times moves down through the tree from A to P to B to D to F.

To access and change the power of 2, press up arrow twice to move up to node B, then press right arrow to move from node B to node O. If you now press + and 3 you will find that this is added to the power, with brackets applied as required. Try redrawing the tree as it would now appear. Node O will now be the addition operation with two new nodes below.

- (vi) Finally, exit the CAS by pressing **ON**. Don't press the **HOME** button as the CAS has its own **HOME** view which behaves differently and is covered on page 317.

Note: There can be a problem with the way that the  $\boxed{x^2}$  button is handled. Try going back through the same exercise but pressing the  $\boxed{x^2}$  button at step 3. You will find that this makes it impossible to access and edit the power because the  $\boxed{x^2}$  operation is stored differently.

### In-line editing mode

If you find that you are not able to access part of an expression, or if you have entered an operation at the wrong level then you can highlight and edit an expression 'in-line' as if you were entering it in the calculator's normal HOME view.

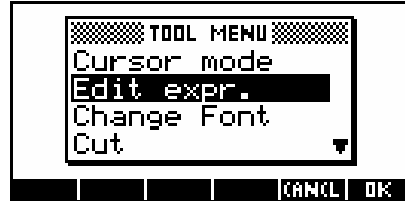
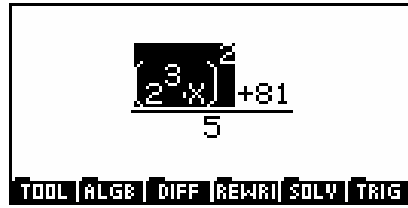

For example, highlight part of an expression as shown right. Now press SK1 (**TOOL**) and choose 'Edit expr.' from the menu. You can now perform any editing you require and the result will be inserted into the full expression at that point.



### Erasing, copying, cutting and pasting

When you press the **DEL** button in the CAS editor the effect is basically to remove nodes of the tree. The first node deleted is the one furthest right in the currently highlighted section.

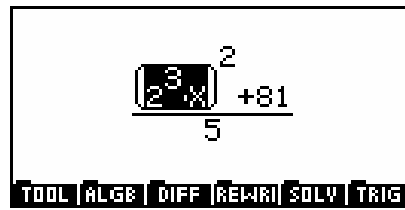

For example, if the highlight was as shown in the screen above, then the current focus would be on node B in the tree shown right. Successively pressing **DEL** would begin at node E, deleting first the node's contents then the operation (multiply) which connected it to the tree. Try it and see.

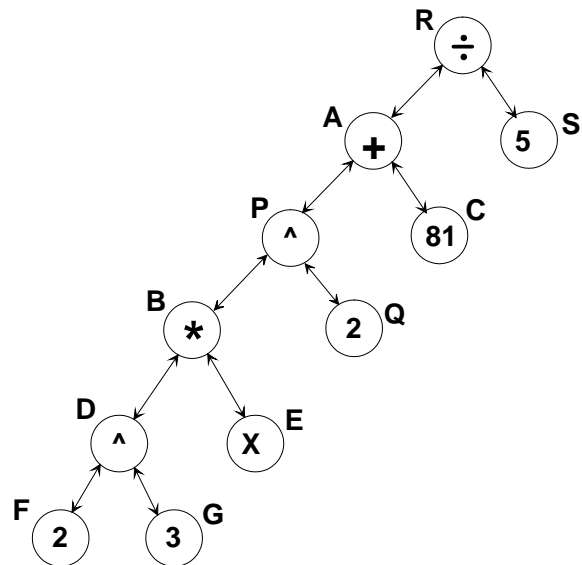

This process is best seen with experimentation. My experience has been that if you are simply wishing to edit a small portion of the expression then the best method may be to use the 'Edit Expr.' command in the **TOOL** menu. The tree structure used by the editor means that although it is usually very easy to add new operations and expressions within an existing one, it can sometimes be frustratingly difficult.

If you want to delete the entire expression then the simplest method is to press **ON** and exit the CAS and then re-enter it with a blank screen. Alternatively you can highlight part or all of the expression and then press **SHIFT ALPHA CLEAR**. The highlighted section will be cleared.

Cutting and pasting of all or part of an expression can be easily done using the **TOOL** menu. This provides access to commands of **Cut**, **Copy** and **Paste** which behave in exactly the same manner as they do in any word processor.

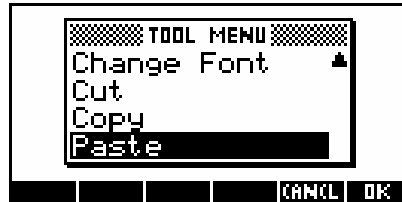

Simply highlight the relevant portion of the expression first and then either cut or copy it. Then move to the new position and paste it. As you can imagine from the tree structure the results of a paste can sometimes be unexpected but generally they will be satisfactory.

### Cursor mode

Cursor mode can be used to select portions of an expression by drawing a box around it. From the **TOOL** menu, select '**Cursor mode**'. Use the arrow keys to move a cursor around on the screen. As you do so it places a box around different parts of the expression that are selectable. Press **ENTER** to select that section.

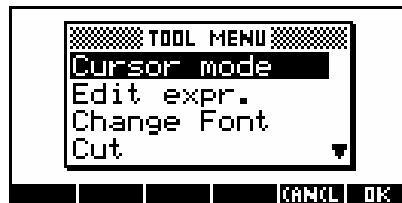

### The CAS HOME History

The CAS has its own history which is essentially similar in its behavior to the normal HOME History. If you press HOME while in the CAS then you will see something similar to the view on the right, with all previous calculations and results recorded. As with the normal History it is worth deleting the contents regularly by pressing **CLEAR** if the memory is not to be gradually used up.

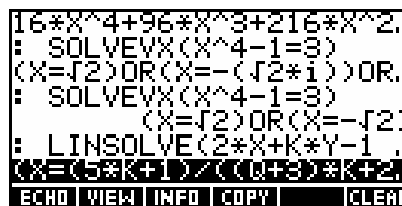

To re-use an expression just highlight it and press **ECHO**. Pressing **COPY** will copy the expression to the clipboard so that you can then **Paste** it using the **TOOL** menu. Pressing **VIEW** will present the expression in scrollable form.

### The PUSH and POP commands

Occasionally it is desirable to transfer results from the normal HOME view to the CAS screen or vice versa. This is done using the **PUSH** and **POP** commands.

Suppose we have just expanded  $(2x+3)^4$  in the CAS, as shown right. If we press **ON** to exit the CAS and then type **POP** in the HOME view then the result will be retrieved to the HOME screen as shown.

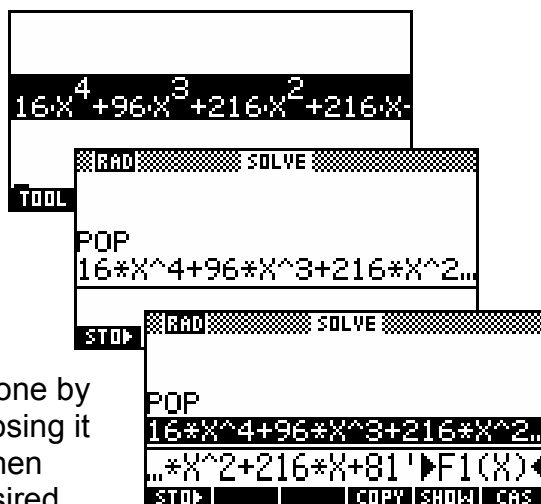

In this case we might wish to also paste the result into the Function applet. This can be done by using **COPY** to retrieve the expression, enclosing it in single quotes from the **CHARS** view and then storing it (►) into  $F1(X)$  or whichever is desired.

The reverse process is also possible using **PUSH** but it is more limited in that you must use the symbolic variable  $S1$ . When you then press **CAS** you will find that seemingly there has been no result. However, pressing **HOME** you will find that the expression has been added to the tail of the CAS History and can now be **ECHO**'d to the editing screen for use.

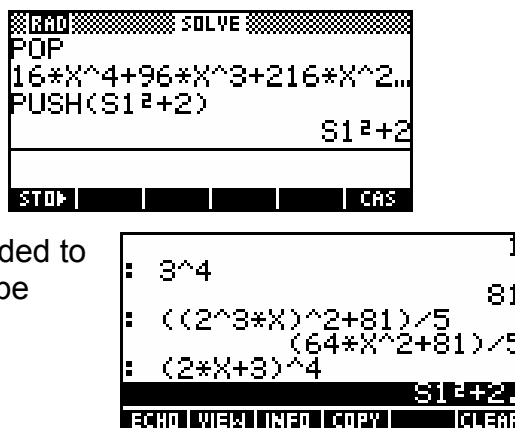

### ***Pasting to an aplet***

As mentioned above, one method of transferring CAS results to a normal aplet such as Function is to use the **POP** command. However, for graphing results, there is an even easier method - simply press **PLOT**.

Suppose that we have a result in the CAS editor as shown right.

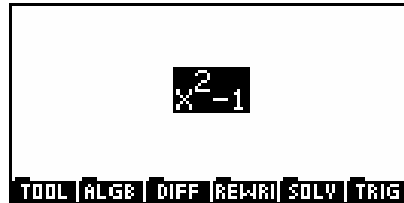

Pressing the **PLOT** button will result in the menu shown in the second screen.



If you choose the Function aplet then you will be asked to nominate a destination.

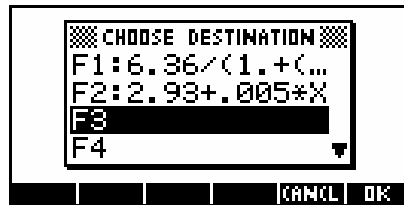

All you need then do is exit the CAS and enter the Function aplet.

### Evaluating algebraic expressions

When an expression is highlighted, pressing **ENTER** will cause it to be algebraically evaluated and any functions to be applied accordingly. For example, if you highlight  $(2x+3)^3$  as shown right then pressing **ENTER** will give the result shown.

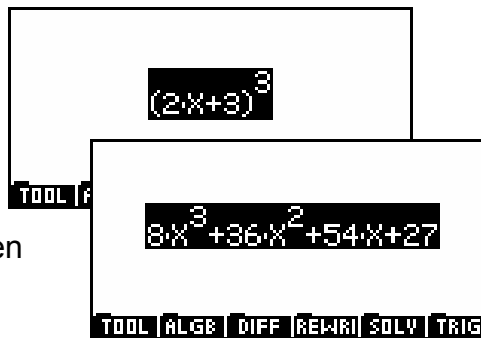

Further examples are shown below. In each case it is only the highlighted expression which is evaluated. Depending on the settings of **CAS MODES** there may or may not be intermediate steps displayed between those shown.

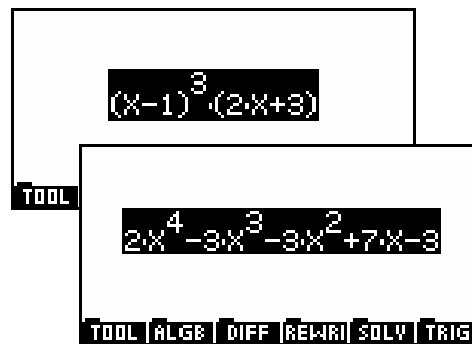
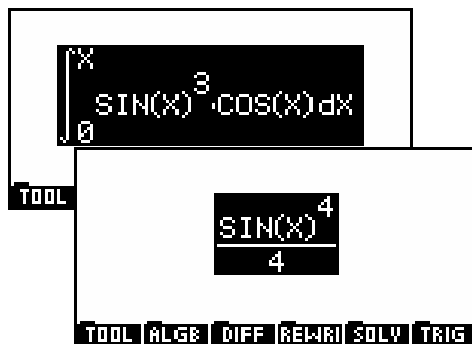

Notice the lack of a '+c' indefinite constant in the integration result. Here, this is because we are using the definite integral (see page 81 and the page following). A better alternative is to use the **INTVX** function as shown below, even though it still does not add the '+c'. See the page after this for information on using functions in the CAS.

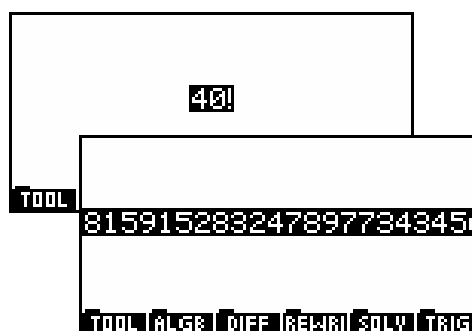
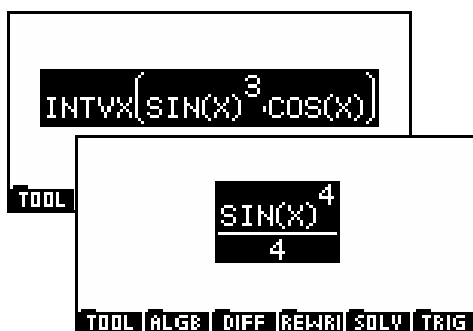

#### Calculator Tip

The result of the  $40!$  example above extends off the edge of the screen and pressing **▶** will not scroll it. If you press the **IEWS** button, then you will find that it can now be scrolled and the entire value seen - all 48 digits of it.



## Using functions in the CAS

The behavior of the **MATH** menu is somewhat similar in the CAS except that it gives access to a host of new functions available primarily in the CAS. These functions will only be available on the hp 40g, not on the hp 39g+.

There are two ways that functions can be used. The first is to use them as the expression is entered. In this method the order is to choose the function and then to fill in the parameters required. The second is to apply a function to all or part of an expression that has resulted from a previous calculation.

### E.g. 1 Using LIMIT

$$\text{Find } \lim_{x \rightarrow 7} \frac{x^2 - 2x - 35}{x - 7}.$$

The sequence of keys for this is...

**DIFF** scroll to **LIMIT** ENTER  
 $\boxed{\text{XT}\theta}$   $\boxed{\text{X}^2}$  - 2  $\boxed{\text{XT}\theta}$  - 35  $\blacktriangle$   $\blacktriangle$   $\blacktriangle$   
 /  $\boxed{\text{XT}\theta}$  - 7  $\blacktriangleright$  7  $\blacktriangle$   $\blacktriangle$  ENTER

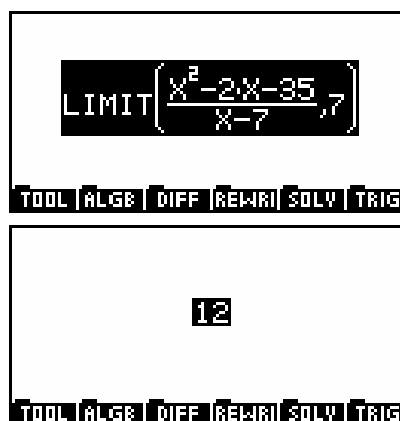

$$\text{Find } \lim_{x \rightarrow 2^+} \frac{1}{x - 2}.$$

The sequence of keys for this is...

**DIFF** scroll to **LIMIT** ENTER  
 1 /  $\boxed{\text{XT}\theta}$  - 2  $\blacktriangleright$  2 + **MATH**  $\blacktriangleright$   
 scroll to **QUOTE** ENTER  
 $\blacktriangle$   $\blacktriangle$   $\blacktriangle$   $\blacktriangle$  ENTER  
 ENTER

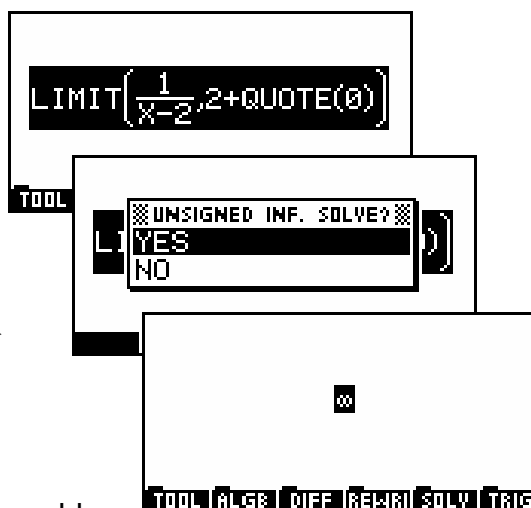

Note: The limit approached from below would be entered as 2 - QUOTE(0).

## E.g. 2 Factorizing expressions

If you highlight an expression such as  $(2x+3)^4$  and press **ENTER** then the CAS will expand the bracket. Since the result extends beyond the screen we will scroll through it using the arrow keys. The results can be factorized again using the **COLLECT** function.

In this example we will also illustrate the use of the CAS History to fetch a previous calculation.

The sequence of keys for this is...

- (i) Expansion...

2  $\boxed{\text{XT0}}$  + 3  $\boxed{\text{XT0}}$  - 35  $\blacktriangle$   $\blacktriangle$   
 $\boxed{\text{XY}}$  4  $\blacktriangle$   $\blacktriangle$  **ENTER**

- (ii) Examination...

$\blacktriangledown$   $\blacktriangleright$   $\blacktriangleright$   $\blacktriangleright$   $\blacktriangleright$  **ON**

- (iii) Retrieving...

**CAS** **HOME** **ECHO**

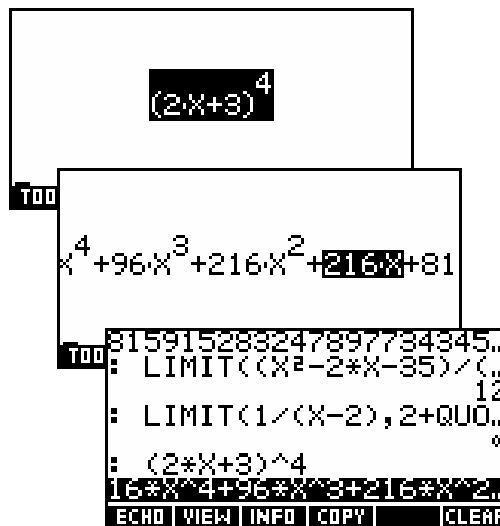

Any recorded previous calculation or result can be retrieved in this way, just as it can in the normal **HOME** history.

- (iv) Factorization...

While the required expression is highlighted, fetch the **COLLECT** function from the **ALGE** menu by pressing SK2.

**ALGE** **ENTER** **ENTER**

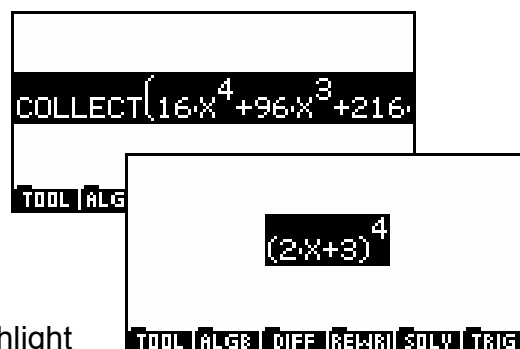

Note: Remember that the extent of the highlight plays a very important role.

- Firstly, the brackets for the inserted **COLLECT** function will enclose whatever portion of the expression is highlighted. This allows partial factorizations. In this case the entire expression must be highlighted before **COLLECT** is inserted.
- Secondly, when **ENTER** is pressed the evaluation is done on whatever is highlighted. It is necessary for the entire expression, including **COLLECT**, to be highlighted if it is to be evaluated.

### E.g. 3 Solving equations

Solve the equation  $x^4 - 1 = 3$ , giving i) real solutions and ii) complex solutions.

From any of the screen menus, access the CFG menu (see page 329) and ensure that **Real mode** is selected, as shown right.

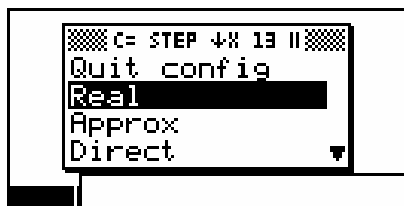

Now use the **SOLVEVX** function, typing:

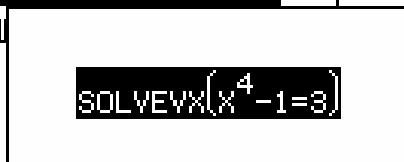

The **SOLVEVX** function assumes that the active variable is being used. The default active variable is **X** and if no = sign is included then the expression is assumed to be equal to zero. The related function of **SOLVE** has a second parameter which allows you to define the variable to be solved for.

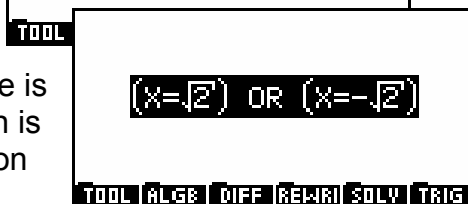

Changing to complex mode in the **CFG** menu will find the other two imaginary solutions:

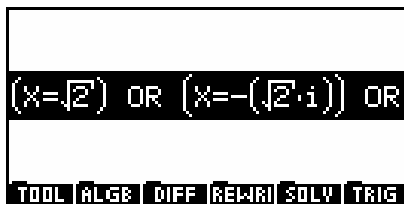

### E.g. 4 Solving simultaneous equations

Solve the following system of equations:  $\begin{cases} x + y = -3 \\ x = y - 1 \end{cases}$

In the CAS, enter: **LINSOLVE(X+Y+3 AND X-Y+1, X AND Y)**. Note that when entering the two equations you must highlight the first one before pressing **AND** (obtained via **SHIFT (-)**).

Alternatively you can use **X+Y=-3 AND X=Y-1** instead of the expressions.

The result is: **(X=-2) AND (Y=-1)**

**LINSOLVE** can be used for any number of simultaneous variables. Step by step mode will show the solution process using row manipulation of an augmented matrix.

The **LINSOLVE** function can also be used to solve problems of the form below.

Solve the system of equations: 
$$\begin{bmatrix} 2 & k \\ q+3 & -1 \end{bmatrix} \times \begin{bmatrix} x \\ y \end{bmatrix} = \begin{bmatrix} 1 \\ 5 \end{bmatrix}$$

The command is

**LINSOLVE( 2.X+K.Y-1 AND (Q+3).X-Y-5, X AND Y)**

and it produces the results shown.

The screenshots show the following steps:

- Command input: **LINSOLVE(2.X+K.Y-1 AND (Q+3).X-Y-5, X AND Y)**
- Row operation: **L2=2.L2-(Q+3).L1**, resulting in the matrix  $\begin{bmatrix} 2 & K & -1 \\ Q+3 & -1 & -5 \end{bmatrix}$ .
- Row operation: **L1=((Q+3)K+2).L1+K.L2**, resulting in the matrix  $\begin{bmatrix} 2 & K & -1 \\ 0 & -((Q+3)K+2) & Q-7 \end{bmatrix}$ .
- Reduction result:  $\begin{bmatrix} (2Q+6)K+4 & 0 & -4 \\ 0 & -((Q+3)K+2) & \end{bmatrix}$ .
- Final solution: **X =  $\frac{5K+1}{(Q+3)K+2}$  AND Y =  $\frac{1}{(Q+3)K+2}$** .

The calculator interface includes a menu bar at the bottom: **TOOL | ALGB | DIFF | REWR | SOLV | TRIG**.

**E.g. 5 Solving a simultaneous integration**

A continuous random variable  $X$ , has a probability distribution function given by:

$$f(x) = \begin{cases} \frac{a+bx+x^2}{9} & \text{for } 1 \leq x \leq 4 \\ 0 & \text{elsewhere} \end{cases}$$

Given that  $P(x \leq 2) = \frac{5}{27}$ , find the values of  $a$  and  $b$ .

From the fact that it is a p.d.f. we know that  $\int_1^4 f(x) dx = 1$ . We can use this to get the first expression in terms of  $a$  and  $b$ .

The calculator sequence shows the following steps:

- Screen 1:  $\int_1^4 \frac{A+Bx+x^2}{9} dx = 1$
- Screen 2:  $\frac{2A+5B+14}{6} = 1$
- Screen 3:  $(\frac{2A+5B+14}{6} = 1) \cdot 6$
- Screen 4:  $2A+5B+8$

As can be seen above, the initial integration gives an equation involving a fraction. This can be simplified by multiplying both sides by 6, highlighting the entire equation first. Notice that when the final simplification is equal to zero, the calculator does not bother to include the ' $=0$ '.

The second probability tells us that  $\int_1^2 f(x) dx = \frac{5}{27}$  and this gives the second of the pair of simultaneous equations in exactly the same fashion.

The calculator sequence shows the following steps:

- Screen 1:  $\int_1^2 \frac{A+Bx+x^2}{9} dx = \frac{5}{27}$
- Screen 2:  $162A+243B+108$

We can now use the **LINSOLVE** function to find A and B. While the second linear equation is still highlighted, fetch the **LINSOLVE** command from the **SOLV** menu. Then press left arrow once and up arrow twice to highlight the linear expression again as shown right.

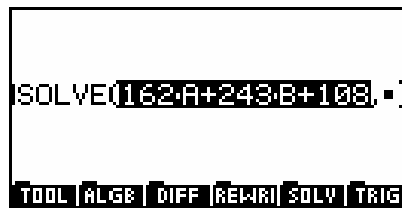

Now, while the entire expression is highlighted, as shown above, press **SHIFT (-)** to obtain the 'AND'. The result should be as shown right.



If yours looks like the version shown to the right then the error has been caused by not having the whole expression highlighted before pressing **AND**. Press **DEL** to remove the **AND**, then do it properly.



The other equation is still available from the CAS History. To fetch it, press **HOME** and highlight the equation. Pressing **ECHO** will echo it to the point of the cursor. Note that if any portion of the expression in the editor is highlighted when you perform an **ECHO** then it will be replaced by the new expression being echoed.

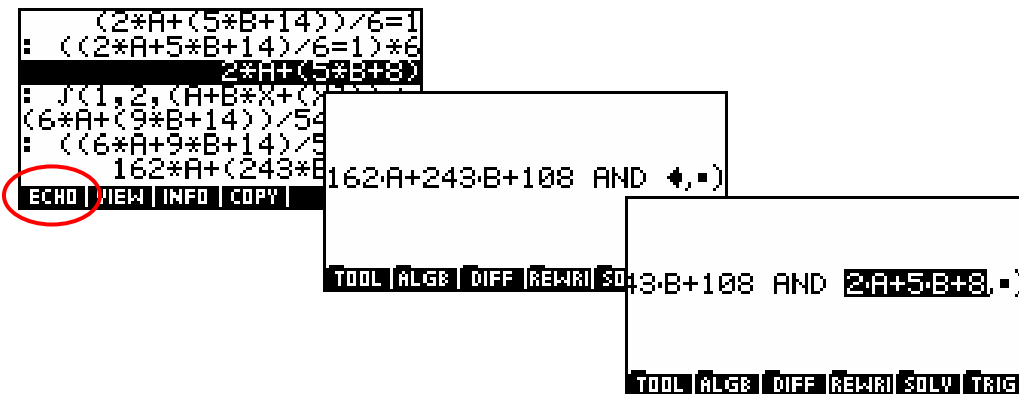

We can then finish off the **LINSOLVE** command by pressing right arrow to move to the second parameter position and then entering "A AND B". At that point we can press **ENTER** to obtain the values of A and B.

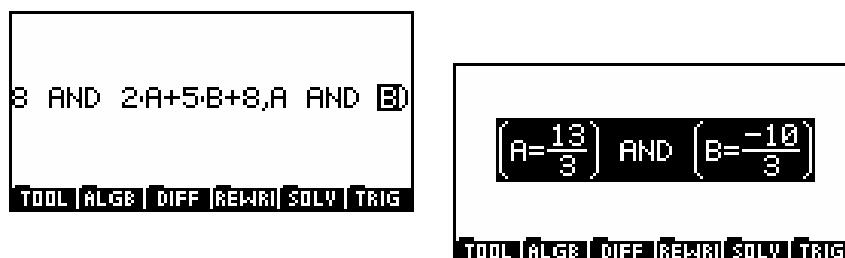

### E.g. 6 Defining a user function

The DEF function allows you to define your own functions, which are then available for use. In the example below it has been used to define Fermat's prime function  $f(x) = 2^{2^x} + 1$ . Note that the sequence of keys is:

**ALGB** ▼ ENTER ALPHA F ( XT0 ▲  
 ▲ SHIFT = 2 X<sup>y</sup> 2 X<sup>y</sup> XT0 ▲ ▲ ▲  
 + 1 ENTER

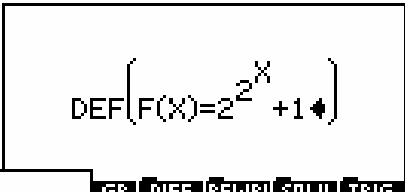

The CAS will then echo the function back to you and, if you go to the VARS view, you will find that it is now a defined variable.



Although we used X as our variable here, there is no reason for this. We could just as easily have defined it as  $f(K) = 2^{2^K} + 1$ .

You can now call this function by simply typing, for example, F(5).

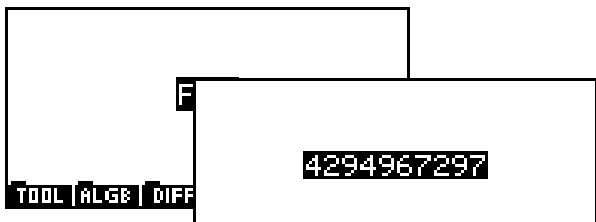

We can now test to see if this is a prime number by using the ISPRIME? function from the MATH menu. This is found in the Integer section as shown right.

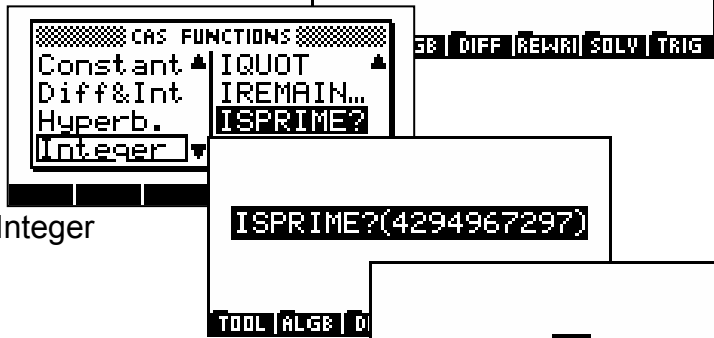

It returns a value of 0 (false) indicating that it is not a prime number.

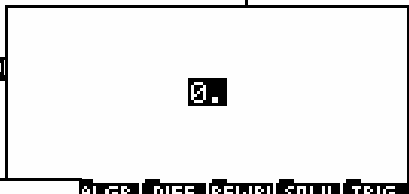

Using the FACTOR function from the ALGB menu shows that its factors are 641 and 6700417.

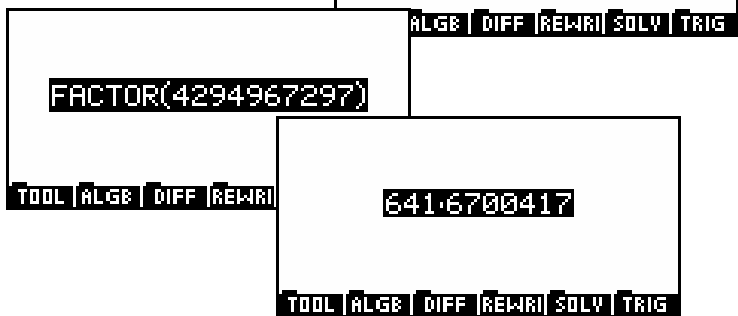

## On-line help

One of the most helpful features of the hp 40g CAS is the on-line help provided by the **SYNTAX** button (**SHIFT 2**). Pressing **SYNTAX** will display the menu shown to the right. You can use the up or down arrow keys to scroll through this list but it is very extensive and it is far quicker to press the button corresponding to the first letter of the function on which you require information. For example, if you want help on the **NEXTPRIME** function then press the  $\div$  button (letter **N**) to jump to the first function beginning with **N**.

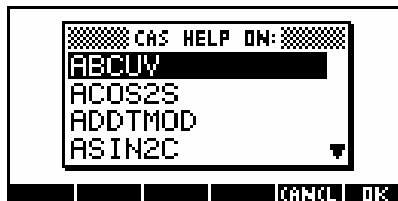

The help screen can be a little crowded, as you can see to the right, but generally contains an extremely useful summary. An example is always given and pressing **ECHO** will cause this example to be pasted into the editing screen.

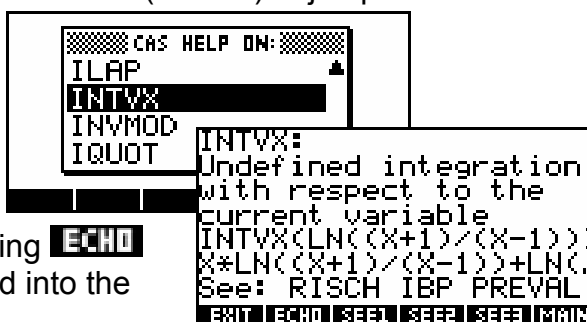

There will often be up to three cross-references to other functions. Pressing **SEE1**, **SEE2**, or **SEE3** will take you to the help screens for these functions.

Pressing **EXIT** will take you back to the editing screen without any action, while pressing **MAIN** will take you back to the **SYNTAX** menu.

It is strongly suggested that you spend some valuable time going carefully through this collection of help pages. They will give you an excellent feel for the capabilities of the CAS.



## Configuring the CAS

This can be done in a number of ways and only an overview will be given here. One method is via the configuration line (CFG) at the top of each menu. The line shown right of **CFG R= X S** means that the calculator is set to **exact-real mode**, that **X** is the current variable, and you are working in **Step by step** mode.



If you select this option of the menu then you will see the further menu shown to the right. At the top of this menu is more information about the current configuration.



The example to the right means that

- |        |  |
|--------|--|
| (R=)   | You are in exact-real mode   |
| (STEP) | Step by step mode is selected  |
| (↓)    | Polynomials are written with their terms in descending order by exponent |
| (X)    | X is the current variable  |
| (13)   | Modular calculations are carried out in $Z/13Z$ ( $p = 13$ ),            |
- and;
- |      |  |
|------|--|
| (  ) | You are working in Rigorous mode (that is, using absolute values). |
|------|--|

Below the title bar you can see the first section of a series of alternatives which let you manipulate the configuration. Most alternatives are toggles having only two values. For example, choosing **Complex** and pressing **ENTER** will cause the menu to momentarily disappear and then re-display with the new setting of **Real**. Pressing **ENTER** again will revert back to **Complex**. Using them you can choose:

- **Quit config** (when you're finished making changes)
- **Complex** (or **Real**)
- **Approx** (or **Exact**)
- **Direct** (or **Step by Step** see following page)
- **1 + x + x<sup>2</sup>** (or **x<sup>2</sup> + x + 1**; governs how polynomials will display)
- **Sloppy** (or **Rigorous**, if you want to work in absolute values)
- **Num. factor** (or **Symb factor**)
- **Cmplx vars** (or **Real vars** if you want all symbolic variables to be assumed to be and treated as real)
- **English** (or **Français** if you want the help screens to be in French)
- **Default cfg** (which is **R = STEP ↓ X 13 ||**).

Pressing **CANCEL** takes you out of the **CFG** menu (as does choosing **QUIT** from the menu and confirming it with **OK**) but does not discard any changes you have made.

The name of the current variable, as well as the value of the variable **MODULO**, can be changed by means of the **SHIFT SYMB** view, or by using the **VARS** key. Many of the configurations addressed in the **CFG** menu are also referenced in these views.

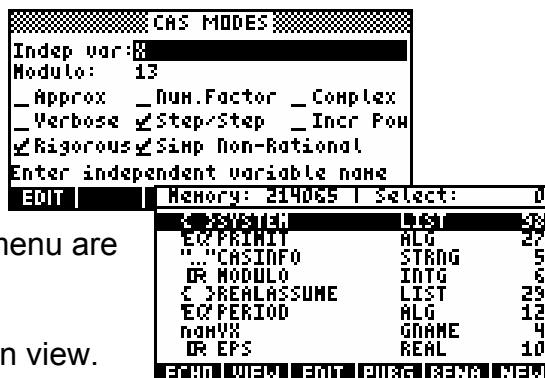

Press **ON** to exit the **VARS** configuration view.



**Calculator Tip**  
 Changing the configuration can have a profound effect on the behavior of the CAS. Only minimal information has been given here, and before you play with these configurations too extensively it is suggested that you read carefully the relevant information in the manual and/or the information in Renée de Graeve's book mentioned in the introduction to this appendix on page 310.

### Tips & Tricks - CAS

- 1) In CAS, angles are always expressed in radians. When you are the calculator **HOME** screen, you can use the **MODES** view to change this default but this does not affect the CAS.
- 2) **step by step** mode is quite useful for students. Choose **Step by step** mode to view the details of the calculations, displayed on the screen. After each step you are requested to press **OK** to proceed to the next stage. The alternative is **Direct mode**, in which only the result is displayed.
- 3) Incredible as it may seem, the CAS is capable of infinite precision when manipulating integers (memory permitting). To see this in action try evaluating 200 factorial and then press **VIEWS**. You can now scroll through all 375 digits of the result!

- 4) Don't use a summation variable of lower-case  $i$ . This is assumed by the CAS to be the unit imaginary value - the root of  $x^2+1=0$ .
- 5) Although you can use the integration symbol provided on the keyboard it has disadvantages outlined on page 82. Use the **INTVX** function instead. See the example on page 320.
- 6) The **COLLECT** function referred to earlier will factorize over the set of integers. For example, **COLLECT**( $x^2-4$ ) will result in  $(x+2)(x-2)$ , whereas **COLLECT**( $x^2+4$ ) will result in  $x^2+4$  back again.

On the other hand the **FACTOR** function will factorize over the irrational and complex sets too. Entering **FACTOR**( $x^2+2$ ) will result in the expression  $(x+\sqrt{2}i)(x-\sqrt{2}i)$ .

- 7) The infinity symbol can be found in the **Constants** section of the **MATH** menu but can also be obtained by pressing **SHIFT 0**. Pressing **(-)** first will produce  $-\infty$ , while pressing **(-)** twice will give  $+\infty$ . These are often needed for use in the **LIMITS** function.

For example, evaluating **LIMIT**( $\sqrt{x+\sqrt{x+\sqrt{x}}}-\sqrt{x}$ ,  $+\infty$ ) will give  $\frac{1}{2}$  (after a very long wait).

As with the infinity symbol there is also a shortcut for the symbol  $i$ . Just press **SHIFT 1**.